

ONE WAY INLET VALVE

TIPO ES 180/88

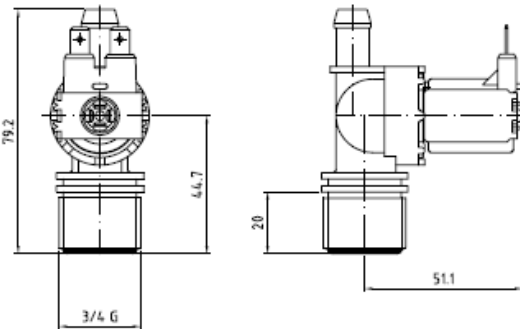

Coils

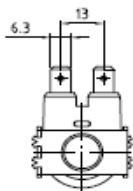

220/240V 50-60Hz 8VA
220/240V 50-60Hz 8VA RINF.
12V 50-60Hz
12V DC
24V 50-60Hz
24V DC

0.2 + 10 bar (0.02 + 1Mpa)
T60°C Tm25°C 100% ED
T60°C Tm90°C AB 3/5MIN

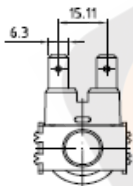

120V 60Hz

0.2 + 10 bar (0.02 + 1Mpa)
T60°C Tm25°C 100% ED
T60°C Tm90°C AB 3/5MIN

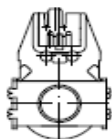

220/240V 50-60Hz 8VA
220/240V 50-60Hz 8VA RINF.
120V 60Hz
24V DC

0.2 + 10 bar (0.02 + 1Mpa)
T60°C Tm25°C 100% ED
T60°C Tm90°C AB 3/5MIN

Inlet thread

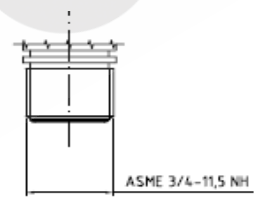

ASME 3/4-11.5 NH

Outlet

Small

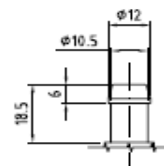

Big

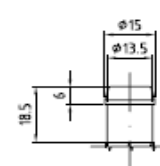

Threaded

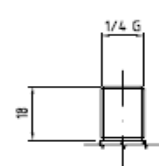

Bracket

Metal

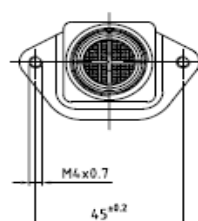

Plastic 45

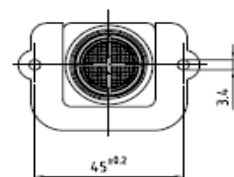

Plastic 50

