



# RESISTENCIAS HEATING ELEMENTS

## RESISTENCIAS ASADOR DE POLLOS CHICKEN ROTISSERIE H. ELEMENTS

### EURAST

	Referencia Code	<b>21362</b>	ORIGINAL
	RESISTENCIA 1000W - 230V 780 mm <b>ASADOR POLLOS</b> • • • HEATING ELEMENT 1000W - 230V 780 mm <b>CHICKEN ROTISSERIE</b>		
Código fabricante / Manufacturer Code		70320289	

### MCM

	Referencia Code	<b>20459</b>	ORIGINAL
	RESISTENCIA 1100W - 230V 864X44 mm <b>ASADOR POLLOS: 1EEN, 2EEN, 3EEN, 4EEN, 5EEN, 6EEN, 6EEND, 8EEND</b> • • • HEATING ELEMENT 1100W - 230V 864X44 mm <b>CHICKEN ROTISSERIE: 1EEN, 2EEN, 3EEN, 4EEN, 5EEN, 6EEN, 6EEND, 8EEND</b>		
Código fabricante / Manufacturer Code		030137-E	

## RESISTENCIAS ASADOR GYROS GYROS GRILL HEATING ELEMENTS

### NAOMI

	Referencia Code	<b>31239</b>	ORIGINAL
	RESISTENCIA CERÁMICA 1600W - 230V 211X175 mm <b>ASADOR GYROS</b> • • • CERAMIC HEATING ELEMENT 1600W - 230V 211X175 mm <b>GYROS GRILL</b>		
Código fabricante / Manufacturer Code		400	

# RESISTENCIAS ASADOR GYROS / GYROS GRILL HEATING ELEMENTS

## NORTH CATERING

	Referencia Code	<b>84889</b> ORIGINAL
	RESISTENCIA 1500W - 230V 350X95X65 mm <b>ASADOR GYROS</b> ••• HEATING ELEMENT 1500W - 230V 350X95X65 mm <b>GYROS GRILL</b>	
Código fabricante / Manufacturer Code		---

## POTIS

	Referencia Code	<b>23842</b> ORIGINAL
	RESISTENCIA 1300W - 230V 270X92X80 mm / M1 4X1.5 <b>ASADOR GYROS: E1, E2, E3</b> ••• HEATING ELEMENT 1300W - 230V 270X92X80 mm / M1 4X1.5 <b>GYROS GRILL: E1, E2, E3</b>	
Código fabricante / Manufacturer Code		PT0094

## POLYDOR

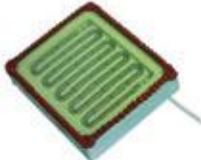
	Referencia Code	<b>23820</b> ORIGINAL
	RESISTENCIA 600W - 230V 150X135X40 mm <b>ASADOR GYROS: SERIE GL</b> ••• HEATING ELEMENT 600W - 230V 150X135X40 mm <b>GYROS GRILL: SERIES GL</b>	
Código fabricante / Manufacturer Code		202130

## Referencia Code

	Referencia Code	<b>23843</b> ORIGINAL
	RESISTENCIA 1500W - 230V 265X93X80 mm / M1 4X1.5 <b>ASADOR GYROS: E1, E2, E3</b> ••• HEATING ELEMENT 1500W - 230V 265X93X80 mm / M1 4X1.5 <b>GYROS GRILL: E1, E2, E3</b>	
Código fabricante / Manufacturer Code		PT0095

## ROLLER GRILL

	Referencia Code	<b>23821</b> ORIGINAL
	RESISTENCIA 600W - 230V 150X135 mm <b>ASADOR GYROS: LC-, POLI, EL-</b> ••• HEATING ELEMENT 600W - 230V 150X135 mm <b>GYROS GRILL: LC-, POLI, EL-</b>	
Código fabricante / Manufacturer Code		202120

## Referencia Code

	Referencia Code	<b>23805</b> ORIGINAL
	RESISTENCIA 2500W - 230V 280X190X130 mm / M12x1.25 <b>ASADOR GYROS: GRE40, GRE60, GRE80</b> ••• HEATING ELEMENT 2500W - 230V 280X190X130 mm / M12x1.25 <b>GYROS GRILL: GRE40, GRE60, GRE80</b>	
Código fabricante / Manufacturer Code		D02075

# RESISTENCIAS BAÑO MARÍA / BAIN MARIE HEATING ELEMENTS

## ALPENINOX

	Referencia Code	<b>19082</b> STANDARD
	RESISTENCIA 550W - 230V 430X45 mm <b>BAÑO MARÍA: SERIE 700</b> ••• HEATING ELEMENT 550W - 230V 430X45 mm <b>BAIN MARIE: SERIE 700</b>	
Código fabricante / Manufacturer Code		A2197

## AMBACH

	Referencia Code	<b>19211</b> STANDARD
	RESISTENCIA 2000W - 230V 483X138 mm <b>BAÑO MARÍA: BMW35/70</b> ••• HEATING ELEMENT 2000W - 230V 483X138 mm <b>BAIN MARIE: BMW35/70</b>	
Código fabricante / Manufacturer Code		5060802391

# RESISTENCIAS BAÑO MARÍA / BAIN MARIE HEATING ELEMENTS

## AMBACH

	Referencia Code	<b>19212</b> STANDARD
		RESISTENCIA 2000W - 230V 410X150 mm
		<b>BAÑO MARÍA:</b> BUC40/70 ••• HEATING ELEMENT 2000W - 230V 410X150 mm
		<b>BAIN MARIE:</b> BUC40/70
Código fabricante / Manufacturer Code		5060801490

	Referencia Code	<b>19213</b> ORIGINAL
		RESISTENCIA 2000W - 400V 482X138 mm
		<b>BAÑO MARÍA:</b> BEW40/80 ••• HEATING ELEMENT 2000W - 400V 482X138 mm
		<b>BAIN MARIE:</b> BEW40/80
Código fabricante / Manufacturer Code		5060802200

	Referencia Code	<b>19214</b> STANDARD
		RESISTENCIA 2000W - 230V 410X150 mm
		<b>BAÑO MARÍA:</b> EBM40/80 ••• HEATING ELEMENT 2000W - 230V 410X150 mm
		<b>BAIN MARIE:</b> EBM40/80
Código fabricante / Manufacturer Code		5060811860

	Referencia Code	<b>19215</b> STANDARD
		RESISTENCIA 2000W - 230V 450X240 mm
		<b>BAÑO MARÍA:</b> EBM45/90 ••• HEATING ELEMENT 2000W - 400V 450X240 mm
		<b>BAIN MARIE:</b> EBM45/90
Código fabricante / Manufacturer Code		5060814436

## ANGELO PO

	Referencia Code	<b>19943</b> ORIGINAL
		RESISTENCIA 1000W - 230V 480X35 mm
		<b>BAÑO MARÍA:</b> ALPHA, OMEGA, DELTA, BIFRONTE ••• HEATING ELEMENT 1000W - 230V 480X35 mm
		<b>BAIN MARIE:</b> ALPHA, OMEGA, DELTA, BIFRONTE
Código fabricante / Manufacturer Code		3262220

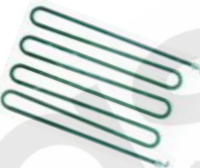
	Referencia Code	<b>19383</b> ORIGINAL
		RESISTENCIA 1450W - 230V 378X252 mm / ROSCA 1/4"
		<b>BAÑO MARÍA:</b> 030EBM, 031EBM ••• HEATING ELEMENT 1450W - 230V 378X252 mm / 1/4" THREAD
		<b>BAIN MARIE:</b> 030EBM, 031EBM
Código fabricante / Manufacturer Code		3260280

	Referencia Code	<b>19382</b> ORIGINAL
		RESISTENCIA 1600W - 230V 585X190 mm / M14X1.5
		<b>BAÑO MARÍA:</b> 60BME, 070BME, 090BME, 071BME, 091BME ••• HEATING ELEMENT 1450W - 230V 585X190 mm / M 14X1.5
		<b>BAIN MARIE:</b> 60BME, 070BME, 090BME, 071BME, 091BME
Código fabricante / Manufacturer Code		3260070

	Referencia Code	<b>34024</b> ORIGINAL
		RESISTENCIA 4800W - 230V 410X417 mm
		<b>BAÑO MARÍA:</b> 60BME, 61BME, S.S.C, CX, CNX ••• HEATING ELEMENT 4800W - 230V 410X417 mm
		<b>BAIN MARIE:</b> 60BME, 61BME, S.S.C, CX, CNX
Código fabricante / Manufacturer Code		3260650

\* CÓDIGO JUNTA / GASKET CODE  
15386

# RESISTENCIAS BAÑO MARÍA / BAIN MARIE HEATING ELEMENTS

## ANGELO PO

Referencia  
Code **19381** ORIGINAL



RESISTENCIA  
800W - 230V  
395X60 mm / ROSCA 1/4"  
**BAÑO MARÍA:** 050BME, 051BME  
• • •  
HEATING ELEMENT  
800W - 230V  
395X60 mm / 1/4" THREAD  
**BAIN MARIE:** 050BME, 051BME

\* CÓDIGO JUNTA / GASKET CODE  
1248

Código fabricante / Manufacturer Code **32G0090**

## BARON

Referencia  
Code **19470** ORIGINAL



RESISTENCIA  
2200W - 230V  
458X186 mm  
**BAÑO MARÍA:** SERIE 700, SERIE 900, GIANO  
• • •  
HEATING ELEMENT  
2200W - 230V  
458X186 mm  
**BAIN MARIE:** SERIES 700, SERIES 900,  
GIANO

Código fabricante / Manufacturer Code **826620101**

## BARON

Referencia  
Code **19468** ORIGINAL



RESISTENCIA  
1500W - 230V  
400X290 mm  
**BAÑO MARÍA:** SERIE 600  
• • •  
HEATING ELEMENT  
1500W - 230V  
400X290 mm  
**BAIN MARIE:** SERIES 600

Código fabricante / Manufacturer Code **826620170**

Referencia  
Code **19469** ORIGINAL



RESISTENCIA  
2500W - 230V  
490X400 mm  
T° MÁX 175°C  
**BAÑO MARÍA:** SERIE 600  
• • •  
HEATING ELEMENT  
2500W - 230V  
490X400 mm  
MÁX T° 175°C  
**BAIN MARIE:** SERIES 600

Código fabricante / Manufacturer Code **826620160**

Referencia  
Code **20208** ORIGINAL



RESISTENCIA  
1500W - 230V  
325X180X34 mm / ROSCA 1/4"  
**BAÑO MARÍA**  
• • •  
HEATING ELEMENT  
1500W - 230V  
325X180X34 mm / 1/4" THREAD  
**BAIN MARIE**

\* CÓDIGO JUNTA / GASKET CODE  
1248

Código fabricante / Manufacturer Code **6A045700**

## BERTO'S

Referencia  
Code **19572** ORIGINAL



RESISTENCIA  
1500W - 230V  
412X50 mm / ROSCA 3/8"  
**BAÑO MARÍA**  
• • •  
HEATING ELEMENT  
1500W - 230V  
412X50 mm / 3/8" THREAD  
**BAIN MARIE**

\* CÓDIGO JUNTA / GASKET CODE  
1248

Código fabricante / Manufacturer Code **22038900**

Referencia  
Code **20209** ORIGINAL



RESISTENCIA  
2000W - 230V  
480X275X60 mm  
**BAÑO MARÍA**  
• • •  
HEATING ELEMENT  
2000W - 230V  
480X275X60 mm  
**BAIN MARIE**

Código fabricante / Manufacturer Code **6A037050**

Referencia  
Code **19573** ORIGINAL



RESISTENCIA  
2600W - 230V  
410X300 mm / ROSCA 3/8"  
**BAÑO MARÍA**  
• • •  
HEATING ELEMENT  
2600W - 230V  
410X300 mm / 3/8" THREAD  
**BAIN MARIE**

\* CÓDIGO JUNTA / GASKET CODE  
1248

Código fabricante / Manufacturer Code **22015800**

# RESISTENCIAS BAÑO MARÍA / BAIN MARIE HEATING ELEMENTS

## BUFFALO



Referencia Code **90251** ORIGINAL

RESISTENCIA  
500W - 230V

BAÑO MARÍA



HEATING ELEMENT  
500W - 230V

BAIN MARIE

Código fabricante / Manufacturer Code **N441**

## DOSILET



Referencia Code **32916** ORIGINAL

RESISTENCIA  
2400W - 230V

BAÑO MARÍA



HEATING ELEMENT  
2400W - 230V

BAIN MARIE

Código fabricante / Manufacturer Code **92042**

## EMMEPI



Referencia Code **19537** ORIGINAL

RESISTENCIA  
1000W - 230V  
220X103X32 mm

BAÑO MARÍA: BM702EB, EBM92EB, 94EB



HEATING ELEMENT  
1000W - 230V  
220X103X32 mm

BAIN MARIE: BM702EB, EBM92EB, 94EB

Código fabricante / Manufacturer Code **C10199**



Referencia Code **22157** ORIGINAL

RESISTENCIA  
1000W - 230V  
400X290 mm

BAÑO MARÍA



HEATING ELEMENT  
1000W - 230V  
400X290 mm

BAIN MARIE

Código fabricante / Manufacturer Code **827136**

## EMMEPI



Referencia Code **19535** ORIGINAL

RESISTENCIA  
1380W - 230V  
346X245X27 mm / ROSCA 1/4"

BAÑO MARÍA: BM652E, BM654E

HEATING ELEMENT  
1380W - 230V

346X245X27 mm / 1/4" THREAD

BAIN MARIE: BM652E, BM654E

\* CÓDIGO JUNTA / GASKET CODE  
1248

Código fabricante / Manufacturer Code **808174**

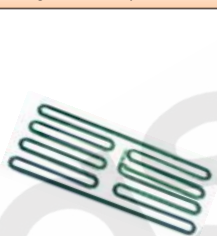

Referencia Code **19533** ORIGINAL

RESISTENCIA  
1800W - 230V  
290X130X30 mm

BAÑO MARÍA: BM704EB, EBM92EB, 94EB

HEATING ELEMENT  
1800W - 230V  
290X130X30 mm

BAIN MARIE: BM704EB, EBM92EB, 94EB

Código fabricante / Manufacturer Code **C00644**



Referencia Code **19536** ORIGINAL

RESISTENCIA  
800W - 230V  
350X87X36 mm / ROSCA 1/4"

BAÑO MARÍA: BM652E, BM654E

HEATING ELEMENT  
800W - 230V  
350X87X36 mm / 1/4" THREAD

BAIN MARIE: BM652E, BM654E

\* CÓDIGO JUNTA / GASKET CODE  
1248

Código fabricante / Manufacturer Code **809070**

## FAGOR



Referencia Code **7479** STANDARD

RESISTENCIA  
1500W - 230V  
320X275 mm

BAÑO MARÍA

HEATING ELEMENT  
1500W - 230V  
320X275 mm

BAIN MARIE

\* CÓDIGO JUNTA / GASKET CODE  
1248

# RESISTENCIAS BAÑO MARÍA / BAIN MARIE HEATING ELEMENTS

## FAGOR

Referencia Code **20269** ORIGINAL



RESISTENCIA  
2800W - 230V  
370X102X27 mm

BAÑO MARÍA: FI30, FI48, FI50, FI64, FI72, FI100, FI120, MF120

HEATING ELEMENT  
2800W - 230V  
370X102X27 mm

BAIN MARIE: FI30, FI48, FI50, FI64, FI72, FI100, FI120, MF120

Código fabricante / Manufacturer Code **Z203601000**

## GIGA

Referencia Code **19573** ORIGINAL



RESISTENCIA  
2600W - 230V  
410X300 mm

BAÑO MARÍA: CBE6, SKB60E

HEATING ELEMENT  
2600W - 230V  
410X300 mm

BAIN MARIE: CBE6, SKB60

\* CÓDIGO JUNTA / GASKET CODE  
1248

Código fabricante / Manufacturer Code **X45900**

## GIGA

Referencia Code **19572** ORIGINAL



RESISTENCIA  
1500W - 230V  
412X50 mm / ROSCA 3/8"

BAÑO MARÍA: CBE4, TB40/80E, SKB40E, SKB80E

HEATING ELEMENT  
1500W - 230V  
412X50 mm / 3/8" THREAD

BAIN MARIE: CBE4, TB40/80E, SKB40E, SKB80E

\* CÓDIGO JUNTA / GASKET CODE  
1248

Código fabricante / Manufacturer Code **X45800**

## GIORIK

Referencia Code **19535** ORIGINAL



RESISTENCIA  
1380W - 230V  
346X245X27 mm / ROSCA 1/4"

BAÑO MARÍA: BM62

HEATING ELEMENT  
1380W - 230V  
346X245X27 mm / 1/4" THREAD

BAIN MARIE: BM62

\* CÓDIGO JUNTA / GASKET CODE  
1248

Código fabricante / Manufacturer Code **6001024**

## HUPFER

Referencia Code **85015** ORIGINAL



RESISTENCIA  
700W - 230V  
350X255 mm

BAÑO MARÍA: SAP-EB

HEATING ELEMENT  
700W - 230V  
350X255 mm

BAIN MARIE: SAP-EB

Código fabricante / Manufacturer Code **014001107-UL**

Referencia Code **19574** ORIGINAL

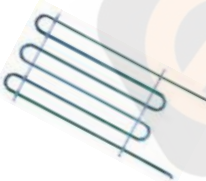

RESISTENCIA  
1500W - 230V  
460X205X52 mm

BAÑO MARÍA: CBE4/8, TB40E, SKB40E

HEATING ELEMENT  
1500W - 230V  
460X205X52 mm

BAIN MARIE: CBE4/8, TB40E, SKB40E

Código fabricante / Manufacturer Code **Y700700**

## INFRICO

Referencia Code **26653** STANDARD



RESISTENCIA  
100W - 230V  
210X58 mm  
THERMOSTATO 130°C

BAÑO MARÍA

HEATING ELEMENT  
100W - 230V  
210X58 mm  
THERMOSTAT 130°C

BAIN MARIE

Referencia Code **19575** ORIGINAL



RESISTENCIA  
1780W - 230V  
650X170X19 mm

BAÑO MARÍA: KB4, KB8

HEATING ELEMENT  
1780W - 230V  
650X170X19 mm

BAIN MARIE: KB4, KB8

\*CÓDIGO JUNTA / GASKET CODE  
1248

Código fabricante / Manufacturer Code **Y10600**

# RESISTENCIAS BAÑO MARÍA / BAIN MARIE HEATING ELEMENTS

## JEMI

Referencia **20373** ORIGINAL  
Code

RESISTENCIA  
1000W - 230V  
700X50 mm

**BAÑO MARÍA:** SERIE 1000, SERIE 1300

HEATING ELEMENT  
1000W - 230V  
700X50 mm

**BAIN MARIE:** SERIES 1000, SERIES 1300



\* CÓDIGO JUNTA / GASKET CODE  
2166

Código fabricante / Manufacturer Code **240003**

Referencia **20371** ORIGINAL  
Code

RESISTENCIA  
500W - 230V  
365X50 mm

**BAÑO MARÍA:** SERIE 600, SERIE 700,  
SERIE 750

HEATING ELEMENT  
500W - 230V  
365X50 mm

**BAIN MARIE:** SERIES 600, SERIES 700,  
SERIES 750



\* CÓDIGO JUNTA / GASKET CODE  
1248

Código fabricante / Manufacturer Code **240001**

Referencia **20372** ORIGINAL  
Code

RESISTENCIA  
750W - 230V  
533X40 mm

**BAÑO MARÍA:** SERIE 900

HEATING ELEMENT  
750W - 230V  
533X40 mm

**BAIN MARIE:** SERIES 900



\* CÓDIGO JUNTA / GASKET CODE  
1248

Código fabricante / Manufacturer Code **240002**

## LOTUS

Referencia **19721** ORIGINAL  
Code

RESISTENCIA  
1300W - 230V  
280X110X20 mm / M10X1

**BAÑO MARÍA:** BM61EM

HEATING ELEMENT  
1300W - 230V  
280X110X20 mm / M10X1

**BAIN MARIE:** BM61EM



\* CÓDIGO JUNTA / GASKET CODE  
1248

Código fabricante / Manufacturer Code **53.7.0048.00**

Referencia **19724** ORIGINAL  
Code

RESISTENCIA  
1500W - 230V  
570X230 mm

**BAÑO MARÍA:** BM94EM, BM98EM

HEATING ELEMENT  
1500W - 230V  
570X230 mm

**BAIN MARIE:** BM94EM, BM98EM



Código fabricante / Manufacturer Code **53.7.0260.00**

Referencia **19722** ORIGINAL  
Code

RESISTENCIA  
650W - 230V  
375X275 mm

**BAÑO MARÍA:** BM74EM, BM78EM,  
BM4EM, BM8EM, BM10EM

HEATING ELEMENT  
650W - 230V  
375X275 mm

**BAIN MARIE:** BM74EM, BM78EM, BM4EM,  
BM8EM, BM10EM



Código fabricante / Manufacturer Code **53.7.0119.00**

## LOTUS

Referencia **19723** ORIGINAL  
Code

RESISTENCIA  
1100W - 230V  
460X375 mm

**BAÑO MARÍA:** BM-6EM, BM-6EMX

HEATING ELEMENT  
1100W - 230V  
460X375 mm

**BAIN MARIE:** BM-6EM, BM-6EMX

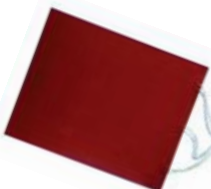

Código fabricante / Manufacturer Code **53.7.0120.00**

## MARENO

Referencia **19907** ORIGINAL  
Code

RESISTENCIA  
1000W - 230V  
400X290 mm

**BAÑO MARÍA:** 3701, 3702, 3703, 3704

HEATING ELEMENT  
1000W - 230V  
400X290 mm

**BAIN MARIE:** 3701, 3702, 3703, 3704



\* CÓDIGO JUNTA / GASKET CODE  
5975

Código fabricante / Manufacturer Code **10.37039513, 892600**

# RESISTENCIAS BAÑO MARÍA / BAIN MARIE HEATING ELEMENTS

## MARENO

	Referencia Code <b>19908</b> ORIGINAL
	<p>RESISTENCIA 1300W - 230V 290X130X18 mm</p> <p><b>BAÑO MARÍA:</b> BME60, BME60-2, BM70-6E</p> <p>HEATING ELEMENT 1300W - 230V 290X130X18 mm</p> <p><b>BAIN MARIE:</b> BME60, BME60-2, BM70-6E</p>

\* CÓDIGO JUNTA / GASKET CODE  
5975

Código fabricante / Manufacturer Code 10.37039600, 10.37039613, 892700

	Referencia Code <b>19911</b> ORIGINAL
	<p>RESISTENCIA 1500W - 230V 497X90 mm</p> <p><b>BAÑO MARÍA:</b> BM7, BM7-E</p> <p>HEATING ELEMENT 1500W - 230V 497X90 mm</p> <p><b>BAIN MARIE:</b> BM7, BM7-E</p>

Código fabricante / Manufacturer Code 1634100

	Referencia Code <b>19905</b> ORIGINAL
	<p>RESISTENCIA 1800W - 230V 500X34 mm</p> <p><b>BAÑO MARÍA:</b> BC2E, BA2E, BC4E, BA4E, BC2GS, BA2GS, BC4GS, BA4GS</p> <p>HEATING ELEMENT 1800W - 230V 500X34 mm</p> <p><b>BAIN MARIE:</b> BC2E, BA2E, BC4E, BA4E, BC2GS, BA2GS, BC4GS, BA4GS</p>

Código fabricante / Manufacturer Code 627510

	Referencia Code <b>19909</b> ORIGINAL
	<p>RESISTENCIA 2100W - 230V 490X87 mm</p> <p><b>BAÑO MARÍA:</b> BM7-7E, B9V-4E, B9SB-4E, B7-4E/8E, B9-4E/8E</p> <p>HEATING ELEMENT 2100W - 230V 490X87 mm</p> <p><b>BAIN MARIE:</b> BM7-7E, B9V-4E, B9SB-4E, B7-4E/8E, B9-4E/8E</p>

Código fabricante / Manufacturer Code 1368400

## MARENO

	Referencia Code <b>19904</b> ORIGINAL
	<p>RESISTENCIA 2200W - 230V 410X34 mm</p> <p><b>BAÑO MARÍA:</b> 702 BME, BC-2E, BA2E</p> <p>HEATING ELEMENT 2200W - 230V 410X34 mm</p> <p><b>BAIN MARIE:</b> 702 BME, BC-2E, BA2E</p>

Código fabricante / Manufacturer Code 33610

	Referencia Code <b>19906</b> ORIGINAL
	<p>RESISTENCIA 900W - 230V 295X88 mm</p> <p><b>BAÑO MARÍA:</b> EC2E, EC4E, EC5E</p> <p>HEATING ELEMENT 900W - 230V 295X88 mm</p> <p><b>BAIN MARIE:</b> EC2E, EC4E, EC5E</p>

Código fabricante / Manufacturer Code 59741

## MBM

	Referencia Code <b>22158</b> ORIGINAL
	<p>RESISTENCIA 1500W - 230V 355X203 mm</p> <p><b>BAÑO MARÍA:</b> MINIMA, OMNIA</p> <p>HEATING ELEMENT 1500W - 230V 355X203 mm</p> <p><b>BAIN MARIE:</b> MINIMA, OMNIA</p>

Código fabricante / Manufacturer Code RTCU700280

## MODULAR

	Referencia Code <b>20032</b> ORIGINAL
	<p>RESISTENCIA 1200W - 230V 405X88X32 mm</p> <p><b>BAÑO MARÍA:</b> 65/70BME, 70/70BME</p> <p>HEATING ELEMENT 1200W - 230V 405X88X32 mm</p> <p><b>BAIN MARIE:</b> 65/70BME, 70/70BME</p>

Código fabricante / Manufacturer Code 665.004.00





# RESISTENCIAS BAÑO MARÍA / BAIN MARIE HEATING ELEMENTS

## MODULAR

	Referencia Code	<b>20034</b> ORIGINAL
	RESISTENCIA 1470W - 230V 528X95X30 mm <b>BAÑO MARÍA:</b> 90/80BME HEATING ELEMENT 1470W - 230V 528X95X30 mm <b>BAIN MARIE:</b> 90/80BME	
Código fabricante / Manufacturer Code <b>665.004.00</b>		

	Referencia Code	<b>20030</b> ORIGINAL
	RESISTENCIA 1500W - 230V 275X80X30 mm / ROSCA 1/8" <b>BAÑO MARÍA:</b> 60/_BME HEATING ELEMENT 1500W - 230V 275X80X30 mm / 1/8" THREAD <b>BAIN MARIE:</b> 60/_BME	
Código fabricante / Manufacturer Code <b>665.056.00</b>		

	Referencia Code	<b>20031</b> ORIGINAL
	RESISTENCIA 1800W - 230V 403X128X32 mm <b>BAÑO MARÍA:</b> 65/40BME, 70/40BME HEATING ELEMENT 1800W - 230V 403X128X32 mm <b>BAIN MARIE:</b> 65/40BME, 70/40BME	
Código fabricante / Manufacturer Code <b>665.003.00</b>		

	Referencia Code	<b>20033</b> ORIGINAL
	RESISTENCIA 2200W - 230V 523X134X32 mm <b>BAÑO MARÍA:</b> 90/40BME HEATING ELEMENT 2200W - 230V 523X134X32 mm <b>BAIN MARIE:</b> 90/40BME	
Código fabricante / Manufacturer Code <b>96500100</b>		

## OLIS

	Referencia Code	<b>20208</b> ORIGINAL
	RESISTENCIA 1500W - 230V 325X180X34 mm / ROSCA 1/4" <b>BAÑO MARÍA:</b> 40SEBM, 60SEBM HEATING ELEMENT 1500W - 230V 325X180X34 mm / 1/4" THREAD <b>BAIN MARIE:</b> 40SEBM, 60SEBM	
Código fabricante / Manufacturer Code <b>A045700</b>		

	Referencia Code	<b>20209</b> ORIGINAL
	RESISTENCIA 2000W - 230V 480X275X60 mm <b>BAÑO MARÍA:</b> 74CBE, 78CBE HEATING ELEMENT 2000W - 230V 480X275X60 mm <b>BAIN MARIE:</b> 74CBE, 78CBE	
Código fabricante / Manufacturer Code <b>A037050</b>		

	Referencia Code	<b>20210</b> ORIGINAL
	RESISTENCIA 2000W - 230V 565X200X20 mm <b>BAÑO MARÍA:</b> 92CBE HEATING ELEMENT 2000W - 230V 565X200X20 mm <b>BAIN MARIE:</b> 92CBE	
Código fabricante / Manufacturer Code <b>A037420</b>		

## REPAGAS

	Referencia Code	<b>20341</b> ORIGINAL
	RESISTENCIA 1500W - 230V 500X90 mm <b>BAÑO MARÍA:</b> BM-1100E, BM-92E BM-91E, BM-72E, BM-71E HEATING ELEMENT 1500W - 230V 500X90 mm <b>BAIN MARIE:</b> BM-1100E, BM-92E, BM-91E BM-72E, BM-71E	
Código fabricante / Manufacturer Code <b>22300016</b>		

# RESISTENCIAS BAÑO MARÍA / BAIN MARIE HEATING ELEMENTS

## REPAGAS

Referencia Code **20342** ORIGINAL



RESISTENCIA  
750W - 230V  
250X40 mm

BAÑO MARÍA: BM-35E, BM-65E, BM-45E

• • •

HEATING ELEMENT  
750W - 230V  
250X40 mm

BAIN MARIE: BM-35E, BM-65E, BM-45E

\* CÓDIGO JUNTA / GASKET CODE  
1248

Código fabricante / Manufacturer Code **23200007**

## RIEBER

Referencia Code **84949** ORIGINAL



RESISTENCIA  
833W - 230V  
380X204 mm

BAÑO MARÍA: ZUB, STW, BKW

• • •

HEATING ELEMENT  
833W - 230V  
380X204 mm

BAIN MARIE: ZUB, STW, BKW

Código fabricante / Manufacturer Code **33010111**

## TECNOINOX

Referencia Code **20162** ORIGINAL



RESISTENCIA  
1300W - 230V  
330X200 mm

BAÑO MARÍA: BM35E, BM70E, BM35E7,  
BM70E7

• • •

HEATING ELEMENT  
1300W - 230V  
330X200 mm

BAIN MARIE: BM35E, BM70E, BM35E7,  
BM70E7

Código fabricante / Manufacturer Code **00269**

## ZANUSSI

Referencia Code **22157** ORIGINAL



RESISTENCIA  
1000W - 230V  
400X290 mm

BAÑO MARÍA

• • •

HEATING ELEMENT  
1000W - 230V  
400X290 mm

BAIN MARIE

Código fabricante / Manufacturer Code **032094**

Referencia Code **20162** ORIGINAL



RESISTENCIA  
1300W - 230V  
330X200 mm

BAÑO MARÍA: SME350, SME700

• • •

HEATING ELEMENT  
1300W - 230V  
330X200 mm

BAIN MARIE: SME350, SME700

Código fabricante / Manufacturer Code **04910**

Referencia Code **458** ORIGINAL



RESISTENCIA  
1500W - 230V

BAÑO MARÍA

• • •

HEATING ELEMENT  
1500W - 230V

BAIN MARIE

\* CÓDIGO JUNTA / GASKET CODE  
90740

Código fabricante / Manufacturer Code **026044**

Referencia Code **22159** ORIGINAL



RESISTENCIA  
1500W - 230V  
395X205X25 mm

BAÑO MARÍA: R700, R701, N700, PR700

• • •

HEATING ELEMENT  
1500W - 230V  
395X205X25 mm

BAIN MARIE: R700, R701, N700, PR700

Código fabricante / Manufacturer Code **50933, 50934**

# RESISTENCIAS BAÑO MARÍA / BAIN MARIE HEATING ELEMENTS

## ZANUSSI

	Referencia Code	<b>22161</b> ORIGINAL
	RESISTENCIA 1500W - 230V 395X198 mm	
	BAÑO MARÍA: CMAE400 •••• HEATING ELEMENT 1500W - 230V 395X198 mm	
BAIN MARIE: CMAE400		
Código fabricante / Manufacturer Code		<b>062290</b>

	Referencia Code	<b>22160</b> ORIGINAL
	RESISTENCIA 2300W - 230V 641X180 mm	
	BAÑO MARÍA: HMS-E, HM-E, NME-E •••• HEATING ELEMENT 2300W - 230V 641X180 mm	
BAIN MARIE: HMS-E, HM-E, NME-E		
Código fabricante / Manufacturer Code		<b>51998, 51999</b>

## VARIOS

	Referencia Code	<b>86006</b> STANDARD
	RESISTENCIA 765W - 230V 330X150 mm	
	BAÑO MARÍA: GN3/1 •••• HEATING ELEMENT 765W - 230V 330X150 mm	
BAIN MARIE: GN3/1		

	Referencia Code	<b>84750</b> STANDARD
	RESISTENCIA 1000W - 230V 260X38 mm / M10X1	
	BAÑO MARÍA •••• HEATING ELEMENT 1000W - 230V 260X38 mm / M10X1	
BAIN MARIE		
*CÓDIGO JUNTA / GASKET CODE		1248

## VARIOS

	Referencia Code	<b>85099</b> STANDARD
	RESISTENCIA 1000W - 230V 500X30 mm	
	BAÑO MARÍA •••• HEATING ELEMENT 1000W - 230V 500X30 mm	
BAIN MARIE		

	Referencia Code	<b>89957</b> STANDARD
	RESISTENCIA 1000W - 230V 394X240 mm	
	BAÑO MARÍA •••• HEATING ELEMENT 1000W - 230V 394X240 mm	
BAIN MARIE		

	Referencia Code	<b>84631</b> STANDARD
	RESISTENCIA 1350W - 230V 435X46 mm	
	BAÑO MARÍA •••• HEATING ELEMENT 1350W - 230V 435X46 mm	
BAIN MARIE		
*CÓDIGO JUNTA / GASKET CODE		1248

	Referencia Code	<b>84201</b> STANDARD
	RESISTENCIA 1400W - 230V 350X30 mm	
	BAÑO MARÍA •••• HEATING ELEMENT 1400W - 230V 350X30 mm	
BAIN MARIE		
*CÓDIGO JUNTA / GASKET CODE		1248

	Referencia Code	<b>84200</b> STANDARD
	RESISTENCIA 1500W - 230V 450X135 mm / M14X1.5	
	BAÑO MARÍA •••• HEATING ELEMENT 1500W - 230V 450X135 mm / M14X1.5	
BAIN MARIE		
*CÓDIGO JUNTA / GASKET CODE		1248

# RESISTENCIAS BAÑO MARÍA / BAIN MARIE HEATING ELEMENTS

## VARIOS

	Referencia Code	<b>84847</b> STANDARD
	RESISTENCIA 1500W - 230V 379X35 mm / M14X1.5	
	<b>BAÑO MARÍA</b> ● ● ● HEATING ELEMENT 1500W - 230V 397X35 mm / M14X1.5	
<b>BAIN MARIE</b>		

\* CÓDIGO JUNTA / GASKET CODE  
1248

	Referencia Code	<b>48628</b> STANDARD
	RESISTENCIA 2500W - 230V 390X150 mm	
	<b>BAÑO MARÍA</b> ● ● ● HEATING ELEMENT 2500W - 230V 390X150 mm	
<b>BAIN MARIE</b>		

## VARIOS

	Referencia Code	<b>89957</b> STANDARD
	RESISTENCIA 1000W - 230V 394X240 mm	
	<b>BAÑO MARÍA</b> ● ● ● HEATING ELEMENT 1000W - 230V 394X240 mm	
<b>BAIN MARIE</b>		



CONÉCTATE  
A NUESTRA  
**WEB**  
CONÉCTATE  
A UNASA

# RESISTENCIAS CALENTADOR DE PLATOS PLATE WARMER HEATING ELEMENTS

## EDESA

	Referencia Code	<b>89626</b> ORIGINAL
	RESISTENCIA 480W - 230V	
	<b>CALENTADOR DE PLATOS: CPC</b> ● ● ● HEATING ELEMENT 480W - 230V	
<b>PLATE WARMER: CPC</b>		
Código fabricante / Manufacturer Code		<b>6021250084</b>

## GIGA

	Referencia Code	<b>47529</b> ORIGINAL
	RESISTENCIA 350W - 230V 172X74 mm	
	<b>CALENTADOR DE PLATOS: TSP40E</b> ● ● ● HEATING ELEMENT 350W - 230V 172X74 mm	
<b>PLATE WARMER: TSP40E</b>		
Código fabricante / Manufacturer Code		<b>X48400</b>

## FRANKE

	Referencia Code	<b>48706</b> ORIGINAL
	RESISTENCIA 1500W - 230V	
	<b>CALENTADOR DE PLATOS</b> ● ● ● HEATING ELEMENT 1500W - 230V	
<b>PLATE WARMER</b>		
Código fabricante / Manufacturer Code		<b>5304385</b>



DESCARGATE  
NUESTRO  
CATALOGO  
DE BARISTA  
—  
DOWNLOAD  
OUR BARISTA  
CATALOGUE

\* FORMATO PDF / PDF FILE

# RESISTENCIAS CALIENTA TAPAS

## HOT DISPLAY CABINET HEATING ELEMENTS





### ZANUSSI

	Referencia Code	<b>31240</b>	STANDARD
	RESISTENCIA 1000W - 230V 400X290 mm  <b>CALIENTA TAPAS</b> HEATING ELEMENT 1000W - 230V 400X290 mm  <b>HOT DISPLAY CABINET</b>		
	Referencia Code	<b>6667</b>	STANDARD
	RESISTENCIA 1200W - 230V 310X30 mm  <b>CALIENTA TAPAS</b> HEATING ELEMENT 1200W - 230V 310X30 mm  <b>HOT DISPLAY CABINET</b>		
* CÓDIGO JUNTA / GASKET CODE 1248			

### VARIOS





	Referencia Code	<b>9906</b>	STANDARD
	RESISTENCIA 400W - 230V 400X108 mm  <b>CALIENTA TAPAS</b> HEATING ELEMENT 400W - 230V 400X108 mm  <b>HOT DISPLAY CABINET</b>		
* CÓDIGO JUNTA / GASKET CODE 1248			
	Referencia Code	<b>24433</b>	STANDARD
	RESISTENCIA 500W - 230V 470X218 mm  <b>CALIENTA TAPAS</b> HEATING ELEMENT 500W - 230V 470X218 mm  <b>HOT DISPLAY CABINET</b>		

### VARIOS





	Referencia Code	<b>50414</b>	STANDARD
	RESISTENCIA 500W - 230V 170X30 mm / SALIDA 90°  <b>CALIENTA TAPAS</b> HEATING ELEMENT 500W - 230V 170X30 mm / 90° OUTPUT  <b>HOT DISPLAY CABINET</b>		
* CÓDIGO JUNTA / GASKET CODE 1248			
	Referencia Code	<b>86060</b>	STANDARD
	RESISTENCIA 750W - 230V L = 245 mm  <b>CALIENTA TAPAS</b> HEATING ELEMENT 500W - 230V L = 245 mm  <b>HOT DISPLAY CABINET</b>		
* CÓDIGO JUNTA / GASKET CODE 1248			
	Referencia Code	<b>24296</b>	STANDARD
	RESISTENCIA 1000W - 230V 355X60 mm  <b>CALIENTA TAPAS</b> HEATING ELEMENT 1000W - 230V 355X60 mm  <b>HOT DISPLAY CABINET</b>		
* CÓDIGO JUNTA / GASKET CODE 1248			
	Referencia Code	<b>50410</b>	STANDARD
	RESISTENCIA 1000W - 230V 260X38 mm  <b>CALIENTA TAPAS</b> HEATING ELEMENT 1000W - 230V 260X38 mm  <b>HOT DISPLAY CABINET</b>		
* CÓDIGO JUNTA / GASKET CODE 1248			

# RESISTENCIAS CALIENTA TAPAS HOT DISPLAY CABINET HEATING ELEMENTS

## VARIOS

 <p>* CÓDIGO JUNTA / GASKET CODE 1248</p>	<p><b>Referencia Code</b> <b>11401</b> STANDARD</p> <p>RESISTENCIA 1200W - 230V L = 369 mm / SALIDA 90°</p> <p><b>CALIENTA TAPAS</b> ● ● ● ● HEATING ELEMENT 1200W - 230V L = 369 mm / 90° OUTPUT</p> <p><b>HOT DISPLAY CABINET</b></p>
 <p>* CÓDIGO JUNTA / GASKET CODE 1248</p>	<p><b>Referencia Code</b> <b>84201</b> STANDARD</p> <p>RESISTENCIA 1400W - 230V 350X30 mm</p> <p><b>CALIENTA TAPAS</b> ● ● ● ● HEATING ELEMENT 1400W - 230V 350X30 mm</p> <p><b>HOT DISPLAY CABINET</b></p>
 <p>* CÓDIGO JUNTA / GASKET CODE 960</p>	<p><b>Referencia Code</b> <b>32606</b> STANDARD</p> <p>RESISTENCIA 1500W - 230V 380X100 mm</p> <p><b>CALIENTA TAPAS</b> ● ● ● ● HEATING ELEMENT 1500W - 230V 380X100 mm</p> <p><b>HOT DISPLAY CABINET</b></p>
 <p>* CÓDIGO JUNTA / GASKET CODE 1248</p>	<p><b>Referencia Code</b> <b>6934</b> STANDARD</p> <p>RESISTENCIA 1800W - 230V L = 504 mm</p> <p><b>CALIENTA TAPAS</b> ● ● ● ● HEATING ELEMENT 1800W - 230V L = 504 mm</p> <p><b>HOT DISPLAY CABINET</b></p>

## VARIOS

 <p>* CÓDIGO JUNTA / GASKET CODE 1248</p>	<p><b>Referencia Code</b> <b>21600</b> STANDARD</p> <p>RESISTENCIA 1800W - 230V 470X30 mm</p> <p><b>CALIENTA TAPAS</b> ● ● ● ● HEATING ELEMENT 1800W - 230V 470X30 mm</p> <p><b>HOT DISPLAY CABINET</b></p>
 <p>* CÓDIGO JUNTA / GASKET CODE 1248</p>	<p><b>Referencia Code</b> <b>27876</b> STANDARD</p> <p>RESISTENCIA 2400W - 230V 640X30 mm</p> <p><b>CALIENTA TAPAS</b> ● ● ● ● HEATING ELEMENT 2400W - 230V 640X30 mm</p> <p><b>HOT DISPLAY CABINET</b></p>
 <p>* CÓDIGO JUNTA / GASKET CODE 1248</p>	<p><b>Referencia Code</b> <b>50420</b> STANDARD</p> <p>RESISTENCIA 2400W - 230V 704X45 mm / SALIDA 90°</p> <p><b>CALIENTA TAPAS</b> ● ● ● ● HEATING ELEMENT 2400W - 230V 704X45 mm / 90° OUTPUT</p> <p><b>HOT DISPLAY CABINET</b></p>
 <p>* CÓDIGO JUNTA / GASKET CODE 1248</p>	<p><b>Referencia Code</b> <b>50412</b> STANDARD</p> <p>RESISTENCIA 3000W - 230V 780X30 mm</p> <p><b>CALIENTA TAPAS</b> ● ● ● ● HEATING ELEMENT 3000W - 230V 780X30 mm</p> <p><b>HOT DISPLAY CABINET</b></p>

# RESISTENCIAS CARRO CALIENTE / HOT TROLLEY HEATING ELEMENTS

## DISTFORM

Referencia Code **89272** ORIGINAL



RESISTENCIA  
3000W - 230V  
355X330 mm

CARRO CALIENTE: ACR-1



HEATING ELEMENT  
3000W - 230V  
355X330 mm

HOT TROLLEY: ACR-1

\*CÓDIGO JUNTA / GASKET CODE  
1248

Código fabricante / Manufacturer Code **CCARE004**

## FRANKE

Referencia Code **51478** ORIGINAL



RESISTENCIA  
3000W - 230V  
370X80 mm

CARRO CALIENTE



HEATING ELEMENT  
3000W - 230V  
370X80 mm

HOT TROLLEY

\*CÓDIGO JUNTA / GASKET CODE  
1248

Código fabricante / Manufacturer Code **5304716**

## FAGOR

Referencia Code **53114** ORIGINAL



RESISTENCIA  
1000W - 230V  
385X80X35 mm

CARRO CALIENTE



HEATING ELEMENT  
1000W - 230V  
385X80X35 mm

HOT TROLLEY

\*CÓDIGO JUNTA / GASKET CODE  
1248

Código fabricante / Manufacturer Code **6021250024**

Referencia Code **85379** ORIGINAL



RESISTENCIA  
3000W - 230V  
320X185 mm

CARRO CALIENTE: CC10, CC20, CC40



HEATING ELEMENT  
3000W - 230V  
320X185 mm

HOT TROLLEY: CC10, CC20, CC40

\*CÓDIGO JUNTA / GASKET CODE  
1248

Código fabricante / Manufacturer Code **CCARE004**

## FRANKE

Referencia Code **85380** ORIGINAL



RESISTENCIA  
1500W - 230V

CARRO CALIENTE: CC10, CC20



HEATING ELEMENT  
1500W - 230V

HOT TROLLEY: CC10, CC20

\*CÓDIGO JUNTA / GASKET CODE  
1248

Código fabricante / Manufacturer Code **5304820**





# RESISTENCIAS COCINA ELÉCTRICA / ELECTRIC RANGE HEATING ELEMENTS

## AMBACH

	Referencia Code	<b>19333</b> ORIGINAL
		RESISTENCIA 1350W - 400V 228X218X82 mm
	<b>COCINA:</b>	EKE40, EKE70, EPE40, EPS40, EPS80
		HEATING ELEMENT 1350W - 400V 228X218X82 mm
	<b>RANGE:</b>	EKE40, EKE70, EPE40, EPS40, EPS80
Código fabricante / Manufacturer Code		5060808461

	Referencia Code	<b>19335</b> ORIGINAL
		RESISTENCIA 1350W - 400V 225X277X80 mm
	<b>COCINA:</b>	EPE80
		HEATING ELEMENT 1350W - 400V 225X277X80 mm
	<b>RANGE:</b>	EPE80
Código fabricante / Manufacturer Code		5060808463

	Referencia Code	<b>19334</b> ORIGINAL
		RESISTENCIA 1650W - 400V 260X245X100 mm
	<b>COCINA:</b>	EKE40, EKE70, EPE40, EPS40, EPS80
		HEATING ELEMENT 1650W - 400V 260X245X100 mm
	<b>RANGE:</b>	EKE40, EKE70, EPE40, EPS40, EPS80
Código fabricante / Manufacturer Code		5060808462

	Referencia Code	<b>19336</b> ORIGINAL
		RESISTENCIA 1650W - 400V 255X330X72 mm
	<b>COCINA:</b>	EPE80
		HEATING ELEMENT 1650W - 400V 255X330X72 mm
	<b>RANGE:</b>	EPE80
Código fabricante / Manufacturer Code		5060808465

## AMBACH

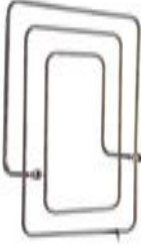
	Referencia Code	<b>19337</b> ORIGINAL
		RESISTENCIA 1700W - 400V 220X300X55 mm
	<b>COCINA:</b>	EPE40D
		HEATING ELEMENT 1700W - 400V 220X300X55 mm
	<b>RANGE:</b>	EPE40D
Código fabricante / Manufacturer Code		5060808465

	Referencia Code	<b>19339</b> ORIGINAL
		RESISTENCIA 1700W - 400V 275X305X70 mm
	<b>COCINA:</b>	EPE80D
		HEATING ELEMENT 1700W - 400V 275X305X70 mm
	<b>RANGE:</b>	EPE80D
Código fabricante / Manufacturer Code		5060808467

	Referencia Code	<b>19338</b> ORIGINAL
		RESISTENCIA 2000W - 400V 340X355X80 mm
	<b>COCINA:</b>	EPE40D
		HEATING ELEMENT 2000W - 400V 340X355X80 mm
	<b>RANGE:</b>	EPE40D
Código fabricante / Manufacturer Code		5060808466

	Referencia Code	<b>19340</b> ORIGINAL
		RESISTENCIA 2000W - 400V 300X340X68 mm
	<b>COCINA:</b>	EPE80D
		HEATING ELEMENT 2000W - 400V 300X340X68 mm
	<b>RANGE:</b>	EPE80D
Código fabricante / Manufacturer Code		5060808468



# RESISTENCIAS COCINA VITROCERÁMICA

## VITROCERAMIC HOB HEATING ELEMENTS

### AMBACH

Referencia Code **20171** ORIGINAL

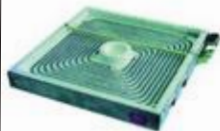

RESISTENCIA  
4000W - 400V  
300X300 mm

**COCINA:** CH40, CH80, CH45, CH90

• • •

HEATING ELEMENT  
4000W - 400V  
300X300 mm

**RANGE:** CH40, CH80, CH45, CH90

Código fabricante / Manufacturer Code **5060810556**

Referencia Code **20258** ORIGINAL



RESISTENCIA  
4000W - 400V  
300X300 mm

**COCINA:** CH40T, CH80T, CH45Y, CH85T

• • •

HEATING ELEMENT  
4000W - 400V  
300X300 mm

**RANGE:** CH40T, CH80T, CH45Y, CH90T

Código fabricante / Manufacturer Code **5060810557**

### ANGELO PO

Referencia Code **19717** ORIGINAL



RESISTENCIA  
1000+1500W - 230V  
Ø250 mm

**COCINA**

• • •

HEATING ELEMENT  
1000+1500W - 230V  
Ø250 mm

**RANGE**

Código fabricante / Manufacturer Code **3007650**

### BARON

Referencia Code **19578** ORIGINAL



RESISTENCIA  
1200W - 230V  
Ø165 mm

**COCINA:** SERIES 600, SERIES 700

• • •  
HEATING ELEMENT  
1200W - 230V  
Ø165 mm

**RANGE:** SERIES 600, SERIES 700

Código fabricante / Manufacturer Code **853400060**

Referencia Code **19717** ORIGINAL



RESISTENCIA  
1000+1500W - 230V  
Ø250 mm

**COCINA:** SERIE 600, SERIE 700, SERIE 900

• • •  
HEATING ELEMENT  
1000+1500W - 230V  
Ø250 mm

**RANGE:** SERIES 600, SERIES 700, SERIES 900

Código fabricante / Manufacturer Code **853400040**

Referencia Code **19718** ORIGINAL



RESISTENCIA  
3400W - 230V  
Ø300 mm

**COCINA:** SERIE 700, SERIE 900

• • •  
HEATING ELEMENT  
3400W - 230V  
Ø300 mm

**RANGE:** SERIES 700, SERIES 900

Código fabricante / Manufacturer Code **853400030**

### EMMEPI

Referencia Code **20259** ORIGINAL



RESISTENCIA  
1800W - 230V  
Ø180 mm

**COCINA:** 652EV, 654EV, 654EVF, 702EV, 704EV, 570EV

• • •  
HEATING ELEMENT  
1800W - 230V  
Ø180 mm

**RANGE:** 652EV, 654EV, 654EVF, 702EV, 704EV, 570EV

Código fabricante / Manufacturer Code **809043**

# RESISTENCIAS COCINA VITROCERÁMICA

## VITROCERAMIC HOB HEATING ELEMENTS

### EMMEPI

	Referencia Code <b>19547</b> ORIGINAL
	RESISTENCIA 2100W - 230V Ø230 mm <b>COCINA:</b> 652EV, 654EV, 654EVF, 702EV, 704EV, 570EV • • • HEATING ELEMENT 2100W - 230V Ø230 mm <b>RANGE:</b> 652EV, 654EV, 654EVF, 702EV, 704EV, 570EV

Código fabricante / Manufacturer Code **809396**

	Referencia Code <b>19548</b> ORIGINAL
	RESISTENCIA 2100W - 230V Ø230 mm <b>COCINA:</b> 652EV, 654EV, 654EVF, 702EV, 704EV, 570EV • • • HEATING ELEMENT 2100W - 230V Ø230 mm <b>RANGE:</b> 652EV, 654EV, 654EVF, 702EV, 704EV, 570EV

Código fabricante / Manufacturer Code **809127**

	Referencia Code <b>19549</b> ORIGINAL
	RESISTENCIA 3400W - 230V 300X300 mm <b>COCINA:</b> EVC7, EVC9 • • • HEATING ELEMENT 3400W - 230V 300X300 mm <b>RANGE:</b> EVC7, EVC9

Código fabricante / Manufacturer Code **809045**

### GIGA

	Referencia Code <b>20259</b> ORIGINAL
	RESISTENCIA 1800W - 230V Ø180 mm <b>COCINA:</b> CCV80E, CCV81E • • • HEATING ELEMENT 1800W - 230V Ø180 mm <b>RANGE:</b> CCV80E, CCV81E

Código fabricante / Manufacturer Code **Y12207**

	Referencia Code <b>19579</b> ORIGINAL
	RESISTENCIA 2200W - 230V Ø230 mm <b>COCINA:</b> C2V, C4V, C4VFE, C4VFLE • • • HEATING ELEMENT 2200W - 230V Ø230 mm <b>RANGE:</b> C2V, C4V, C4VFE, C4VFLE

Código fabricante / Manufacturer Code **Y12409**

	Referencia Code <b>19580</b> ORIGINAL
	RESISTENCIA 2500W - 230V Ø250 mm <b>COCINA:</b> C2V, C4V, C4VFE, C4VFLE • • • HEATING ELEMENT 2500W - 230V Ø250 mm <b>RANGE:</b> C2V, C4V, C4VFE, C4VFLE

Código fabricante / Manufacturer Code **Y12408**

### GIGA

	Referencia Code <b>19578</b> ORIGINAL
	RESISTENCIA 1200W - 230V Ø165 mm <b>COCINA:</b> CCV80E, CCV81E • • • HEATING ELEMENT 1200W - 230V Ø165 mm <b>RANGE:</b> CCV80E, CCV81E

Código fabricante / Manufacturer Code **Y12208**

### JUNO-RÖDER-SENKING

	Referencia Code <b>20171</b> ORIGINAL
	RESISTENCIA 4000W - 400V 300X300 mm <b>COCINA</b> • • • HEATING ELEMENT 4000W - 400V 300X300 mm <b>RANGE</b>

Código fabricante / Manufacturer Code **214430**

# RESISTENCIAS COCINA VITROCERÁMICA

## VITROCERAMIC HOB HEATING ELEMENTS

### LOTUS

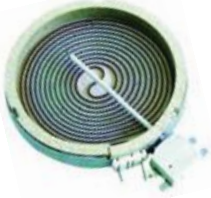

Referencia Code **19578** ORIGINAL

RESISTENCIA  
1200W - 230V  
Ø165 mm

**COCINA:** SERIES 60

HEATING ELEMENT  
1200W - 230V  
Ø165 mm

**RANGE:** SERIES 60

Código fabricante / Manufacturer Code **53.7.0145.01**



Referencia Code **19698** ORIGINAL

RESISTENCIA  
1200W - 230V  
Ø165 mm

**COCINA:** SERIES 60

HEATING ELEMENT  
1200W - 230V  
Ø165 mm

**RANGE:** SERIES 60

Código fabricante / Manufacturer Code **53.7.0145.00**

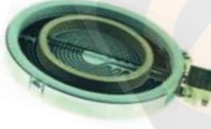

Referencia Code **19699** ORIGINAL

RESISTENCIA  
1700W - 230V  
Ø200 mm

**COCINA:** SERIES 60, SERIES 65

HEATING ELEMENT  
1700W - 230V  
Ø200 mm

**RANGE:** SERIES 60, SERIES 65

Código fabricante / Manufacturer Code **53.7.0146.00**



Referencia Code **19715** ORIGINAL

RESISTENCIA  
1800W - 230V  
Ø200 mm

**COCINA:** SERIE 65

HEATING ELEMENT  
1800W - 230V  
Ø200 mm

**RANGE:** SERIES 65

Código fabricante / Manufacturer Code **53.7.0129.00**

### LOTUS



Referencia Code **19579** ORIGINAL

RESISTENCIA  
2200W - 230V  
Ø230 mm

**COCINA:** SERIE 60

HEATING ELEMENT  
2200W - 230V  
Ø230 mm

**RANGE:** SERIES 60

Código fabricante / Manufacturer Code **53.7.0153.01**



Referencia Code **19716** ORIGINAL

RESISTENCIA  
2200W - 230V  
Ø230 mm

**COCINA:** SERIE 65

HEATING ELEMENT  
2200W - 230V  
Ø230 mm

**RANGE:** SERIES 65

Código fabricante / Manufacturer Code **53.7.0153.00**



Referencia Code **19717** ORIGINAL

RESISTENCIA  
1000+1500W - 230V  
Ø250 mm

**COCINA:** SERIE 70, MINIMA

HEATING ELEMENT  
1000+1500W - 230V  
Ø250 mm

**RANGE:** SERIES 70, MINIMA

Código fabricante / Manufacturer Code **53.7.0194.00**



Referencia Code **19718** ORIGINAL

RESISTENCIA  
3400W - 230V  
Ø300 mm

**COCINA:** SERIE 90

HEATING ELEMENT  
3400W - 230V  
Ø300 mm

**RANGE:** SERIES 90

Código fabricante / Manufacturer Code **53.7.0264.00**

# RESISTENCIAS COCINA VITROCERÁMICA

## VITROCERAMIC HOB HEATING ELEMENTS

### MARENO

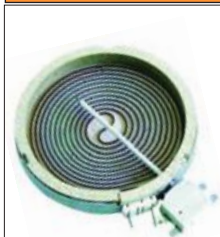

Referencia Code **19578** ORIGINAL

RESISTENCIA  
1200W - 230V  
Ø165 mm

COCINA: PCVE-\_, CFVE-60

HEATING ELEMENT  
1200W - 230V  
Ø165 mm

RANGE: PCVE-\_, CFVE-60

Código fabricante / Manufacturer Code **10.37309600**

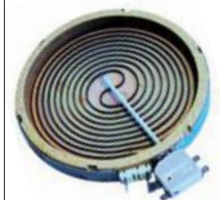

Referencia Code **88762** ORIGINAL

RESISTENCIA  
1800W - 230V  
Ø200 mm

COCINA: PCV-\_, CFVE-60

HEATING ELEMENT  
1800W - 230V  
Ø200 mm

RANGE: PCV-\_, CFVE-60

Código fabricante / Manufacturer Code **10.37309013**



Referencia Code **19717** ORIGINAL

RESISTENCIA  
1000+1500W - 230V  
Ø250 mm

COCINA

HEATING ELEMENT  
1000+1500W - 230V  
Ø250 mm

RANGE

Código fabricante / Manufacturer Code **10.37308913**



Referencia Code **20260** ORIGINAL

RESISTENCIA  
2400W - 230V  
Ø230 mm

COCINA: PCVE-, CFVE-

HEATING ELEMENT  
2400W - 230V  
Ø230 mm

RANGE: PCVE-, CFVE-

Código fabricante / Manufacturer Code **10.37308900**

### MBM



Referencia Code **19717** ORIGINAL

RESISTENCIA  
1000+1500W - 230V  
Ø250 mm

COCINA: MINIMA, OMNIA

HEATING ELEMENT  
1000+1500W - 230V  
Ø250 mm

RANGE: MINIMA, OMNIA

Código fabricante / Manufacturer Code **RIC0001041**

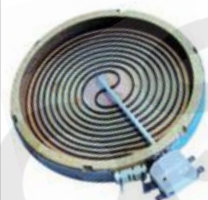

Referencia Code **88762** ORIGINAL

RESISTENCIA  
1800W - 230V  
Ø200 mm

COCINA: MINIMA, OMNIA

HEATING ELEMENT  
1800W - 230V  
Ø200 mm

RANGE: MINIMA, OMNIA

Código fabricante / Manufacturer Code **RIC0001040, RIC0001295**

### MODULAR

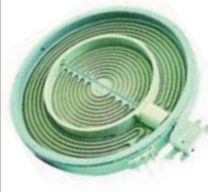

Referencia Code **19717** ORIGINAL

RESISTENCIA  
1000+1500W - 230V  
Ø250 mm

COCINA: SERIE 65/70, SERIE 90/110

HEATING ELEMENT  
1000+1500W - 230V  
Ø250 mm

RANGE: SERIE 65/70, SERIE 90/110

Código fabricante / Manufacturer Code **---**



Referencia Code **19547** ORIGINAL

RESISTENCIA  
2100W - 230V  
Ø230 mm

COCINA: SERIE 65/70

HEATING ELEMENT  
2100W - 230V  
Ø230 mm

RANGE: SERIE 65/70

Código fabricante / Manufacturer Code **---**

# RESISTENCIAS COCINA VITROCERÁMICA

## VITROCERAMIC HOB HEATING ELEMENTS

### MODULAR



Referencia Code	<b>19718</b> ORIGINAL
RESISTENCIA	3400W - 230V Ø300 mm
COCINA:	SERIE 90, SERIE 110 • • •
HEATING ELEMENT	3400W - 230V Ø300 mm
RANGE:	SERIES 90, SERIES 110
Código fabricante / Manufacturer Code	---

### OLIS



Referencia Code	<b>19717</b> ORIGINAL
RESISTENCIA	1000+1500W - 230V Ø250 mm
COCINA	• • •
HEATING ELEMENT	1000+1500W - 230V Ø250 mm
RANGE	
Código fabricante / Manufacturer Code	6A001401

### SILKO



Referencia Code	<b>88762</b> ORIGINAL
RESISTENCIA	1800W - 230V Ø200 mm
COCINA:	MINIMA, OMNIA • • •
HEATING ELEMENT	1800W - 230V Ø200 mm
RANGE:	MINIMA, OMNIA
Código fabricante / Manufacturer Code	103730913

### TECNOINOX



Referencia Code	<b>19717</b> ORIGINAL
RESISTENCIA	1000+1500W - 230V Ø250 mm
COCINA:	PCC35E, PCC70E, PFC70E, PF70E7 • • •
HEATING ELEMENT	1000+1500W - 230V Ø250 mm
RANGE:	PCC35E, PCC70E, PFC70E, PF70E7
Código fabricante / Manufacturer Code	00932



Referencia Code	<b>20259</b> ORIGINAL
RESISTENCIA	1800W - 230V Ø200 mm
COCINA:	PCC35E, PCC70E, PFC70E, PF70E7 • • •
HEATING ELEMENT	1800W - 230V Ø200 mm
RANGE:	PCC35E, PCC70E, PFC70E, PF70E7
Código fabricante / Manufacturer Code	00931

### ZANUSSI





Referencia Code	<b>19716</b> ORIGINAL
RESISTENCIA	2200W - 230V Ø230 mm
COCINA:	MI/E350, MI/E700, MIF/E700 • • •
HEATING ELEMENT	2200W - 230V Ø230 mm
RANGE:	MI/E350, MI/E700, MIF/E700
Código fabricante / Manufacturer Code	A5299



Referencia Code	<b>19718</b> ORIGINAL
RESISTENCIA	3400W - 230V Ø300 mm
COCINA:	HI/E400, HI/E800, NIE400, NIE800 • • •
HEATING ELEMENT	3400W - 230V Ø300 mm
RANGE:	HI/E400, HI/E800, NIE400, NIE800
Código fabricante / Manufacturer Code	02557

# RESISTENCIAS CREPERA / CREPE MACHINE HEATING ELEMENTS

EMMEPI	
	Referencia Code <b>84624</b> ORIGINAL
	RESISTENCIA 2000W - 230V Ø305X280X34 mm
	CREPERA ... HEATING ELEMENT 2000W - 230V Ø305X280X34 mm
	CREPE MACHINE
Código fabricante / Manufacturer Code <b>809923</b>	

ROLLER GRILL	
	Referencia Code <b>89260</b> ORIGINAL
	RESISTENCIA 3000W - 230V Ø310X65 mm
	CREPERA: 350E/ED, 400E/ED ... HEATING ELEMENT 3000W - 230V Ø310X65 mm
	CREPE MACHINE: 350E/ED, 400E/ED
Código fabricante / Manufacturer Code <b>D02013</b>	

FAC	
	Referencia Code <b>84624</b> ORIGINAL
	RESISTENCIA 2000W - 230V Ø305X280X34 mm
	CREPERA: FABA ... HEATING ELEMENT 2000W - 230V Ø305X280X34 mm
	CREPE MACHINE: FABA
Código fabricante / Manufacturer Code <b>NF05C1015</b>	

TINTO EQUIPAMENTS	
	Referencia Code <b>89305</b> ORIGINAL
	RESISTENCIA 2000 - 230V Ø305X34 mm
	CREPERA: S35 ... HEATING ELEMENT 2000W - 230V Ø305X34 mm
	CREPE MACHINE: S35
Código fabricante / Manufacturer Code <b>PR30001</b>	

# RESISTENCIAS CUECE PASTAS / PASTA COOKER HEATING ELEMENTS

AMBACH	
	Referencia Code <b>19322</b> ORIGINAL
	RESISTENCIA 6000W - 230V 390X31X40 mm
	CUECE PASTAS: CPE35, CPE70 ... HEATING ELEMENT 6000W - 230V 390X31X40 mm
	PASTA COOKER: CPE35, CPE70
Código fabricante / Manufacturer Code <b>5060807386, 5060810064</b>	

\*CÓDIGO JUNTA / GASKET CODE 19257

AMBACH	
	Referencia Code <b>19323</b> ORIGINAL
	RESISTENCIA 8000W - 230V 485X33X36 mm
	CUECE PASTAS: EPK40, EPK45 ... HEATING ELEMENT 8000W - 230V 485X33X36 mm
	PASTA COOKER: EPK40, EPK45
Código fabricante / Manufacturer Code <b>5060814407</b>	

\*CÓDIGO JUNTA / GASKET CODE 19257

# RESISTENCIAS CUECE PASTAS / PASTA COOKER HEATING ELEMENTS

## ANGELO PO

Referencia Code **19348** ORIGINAL

RESISTENCIA  
4540W - 230V  
323X36X48 mm

CUECE PASTAS: 30CPSE, 70CPE, 90CPE

• • •

HEATING ELEMENT  
4540W - 230V  
323X36X48 mm

PASTA COOKER: 30CPSE, 70CPE, 90CPE



\*CÓDIGO JUNTA / GASKET CODE  
16601

Código fabricante / Manufacturer Code **32G1300, 32G1301**

Referencia Code **19349** ORIGINAL

RESISTENCIA  
6000W - 400V  
485X37X40 mm

CUECE PASTAS: OAICPIE

• • •

HEATING ELEMENT  
6000W - 400V  
485X37X40 mm

PASTA COOKER: OAICPIE



\*CÓDIGO JUNTA / GASKET CODE  
7358

Código fabricante / Manufacturer Code **32G2310**

## BARON

Referencia Code **19451** ORIGINAL

RESISTENCIA  
2000W - 230V  
280X75 mm

CUECE PASTAS: SERIE 700

• • •

HEATING ELEMENT  
2000W - 230V  
280X75 mm

PASTA COOKER: SERIES 700



\*CÓDIGO JUNTA / GASKET CODE  
1248

Código fabricante / Manufacturer Code **85326002063**

Referencia Code **19450** ORIGINAL

RESISTENCIA  
2200W - 230V  
300X34X42 mm

CUECE PASTAS: SERIE 600

• • •

HEATING ELEMENT  
2200W - 230V  
300X34X42 mm

PASTA COOKER: SERIES 600



\*CÓDIGO JUNTA / GASKET CODE  
90767

Código fabricante / Manufacturer Code **826620150**

## BARON

Referencia Code **19551** ORIGINAL

RESISTENCIA  
2520W - 230V  
452X66 mm

CUECE PASTAS: SERIE 900

• • •

HEATING ELEMENT  
2520W - 230V  
452X66 mm

PASTA COOKER: SERIES 900



\*CÓDIGO JUNTA / GASKET CODE  
1248

Código fabricante / Manufacturer Code **85326002064**

## BERTO'S

Referencia Code **19576** ORIGINAL

RESISTENCIA  
2510W - 230V  
295X115 mm

CUECE PASTAS: ECRM6

• • •

HEATING ELEMENT  
2510W - 230V  
295X115 mm

PASTA COOKER: ECRM6



\*CÓDIGO JUNTA / GASKET CODE  
1248

Código fabricante / Manufacturer Code **22015900**

## EDESA

Referencia Code **88997** ORIGINAL

RESISTENCIA  
1500W - 230V

CUECE PASTAS: SCPE-40

• • •

HEATING ELEMENT  
1500W - 230V

PASTA COOKER: SCPE-40



Código fabricante / Manufacturer Code **K001B31176**

# RESISTENCIAS CUECE PASTAS / PASTA COOKER HEATING ELEMENTS

## EMMEPI

	Referencia Code <b>19451</b> ORIGINAL
	RESISTENCIA 2000W - 230V 280X75 mm / ROSCA 1/4" <b>CUECE PASTAS:</b> SERIE 650, SERIE 700 SERIE 750 ● ● ● <b>HEATING ELEMENT</b> 2000W - 230V 275X64 mm / 1/4" THREAD <b>PASTA COOKER:</b> SERIES 650, SERIES 700, SERIES 750
*CÓDIGO JUNTA / GASKET CODE 1248	
<b>Código fabricante / Manufacturer Code</b> 808056	

	Referencia Code <b>19551</b> ORIGINAL
	RESISTENCIA 2520W - 230V 452X66 mm / ROSCA 1/4" <b>CUECE PASTAS:</b> SERIE 900 ● ● ● <b>HEATING ELEMENT</b> 2520W - 230V 452X66 mm / 1/4" THREAD <b>PASTA COOKER:</b> SERIES 900
*CÓDIGO JUNTA / GASKET CODE 1248	
<b>Código fabricante / Manufacturer Code</b> 808756	

## FRANKE

	Referencia Code <b>51477</b> ORIGINAL
	RESISTENCIA 7500W - 230V <b>CUECE PASTAS</b> ● ● ● <b>HEATING ELEMENT</b> 7500W - 230V <b>PASTA COOKER</b>
*CÓDIGO JUNTA / GASKET CODE 1248	
<b>Código fabricante / Manufacturer Code</b> 5343117	

## GIGA

	Referencia Code <b>19576</b> ORIGINAL
	RESISTENCIA 2510W - 230V 295X115 mm <b>CUECE PASTAS:</b> SKCP40E, SKCP60E, CCPE4 CCPE6, TCP60E, ICPE4, ICPE6 ● ● ● <b>HEATING ELEMENT</b> 2510W - 230V 295X115 mm <b>PASTA COOKER:</b> SKCP40E, SKCP60E, CCPE4 CCPE6, TCP60E, ICPE4, ICPE6
*CÓDIGO JUNTA / GASKET CODE 1248	
<b>Código fabricante / Manufacturer Code</b> 5343117	

## GIORIK

	Referencia Code <b>19451</b> ORIGINAL
	RESISTENCIA 2000W - 230V 280X75 mm / ROSCA 1/4" <b>CUECE PASTAS:</b> SERIE 700 ● ● ● <b>HEATING ELEMENT</b> 2000W - 230V 280X75 mm / 1/4" THREAD <b>PASTA COOKER:</b> SERIES 700
*CÓDIGO JUNTA / GASKET CODE 1248	
<b>Código fabricante / Manufacturer Code</b> 6002063	

	Referencia Code <b>19551</b> ORIGINAL
	RESISTENCIA 2520W - 230V 452X66 mm / ROSCA 1/4" <b>CUECE PASTAS:</b> SERIE 900 ● ● ● <b>HEATING ELEMENT</b> 2520W - 230V 452X66 mm / 1/4" THREAD <b>PASTA COOKER:</b> SERIES 900
*CÓDIGO JUNTA / GASKET CODE 1248	
<b>Código fabricante / Manufacturer Code</b> 6002064	

## JEMI

	Referencia Code <b>8624</b> ORIGINAL
	RESISTENCIA 4500W - 230V 280X60 mm <b>CUECE PASTAS:</b> SERIE 700 ● ● ● <b>HEATING ELEMENT</b> 4500W - 230V 280X60 mm <b>PASTA COOKER:</b> SERIES 700
*CÓDIGO JUNTA / GASKET CODE 3034	
<b>Código fabricante / Manufacturer Code</b> 2001184	

	Referencia Code <b>8657</b> ORIGINAL
	RESISTENCIA 6000W - 230/400V 285X60X35 mm <b>CUECE PASTAS</b> ● ● ● <b>HEATING ELEMENT</b> 6000W - 230/400V 285X60X35 mm <b>PASTA COOKER</b>
*CÓDIGO JUNTA / GASKET CODE 8677	
<b>Código fabricante / Manufacturer Code</b> 2001187	





# RESISTENCIAS CUECE PASTAS / PASTA COOKER HEATING ELEMENTS

## LOTUS

	Referencia Code <b>19719</b> ORIGINAL
	RESISTENCIA 823W - 230V 276X108X20 mm / M10X1
	<b>CUECE PASTAS:</b> CP61EM ••• HEATING ELEMENT 823W - 230V 276X108X20 mm / M10X1
*CÓDIGO JUNTA / GASKET CODE 1248	<b>PASTA COOKER:</b> CP61EM
<b>Código fabricante / Manufacturer Code</b> 53.7.0042.00	

	Referencia Code <b>19720</b> ORIGINAL
	RESISTENCIA 2000W - 230V 276X140X20 mm / M10X1
	<b>CUECE PASTAS:</b> CP61ET, CP62ET, CP-4ET, CP-6ET, CP61EM ••• HEATING ELEMENT 2000W - 230V 276X140X20 mm / M10X1
*CÓDIGO JUNTA / GASKET CODE 1248	<b>PASTA COOKER:</b> CP61ET, CP62ET, CP-4ET, CP-6ET, CP61EM
<b>Código fabricante / Manufacturer Code</b> 53.7.0049.00	

	Referencia Code <b>19725</b> ORIGINAL
	RESISTENCIA 2000W - 230V Ø30X300 mm
	<b>CUECE PASTAS:</b> CP-74ET, CP-78ET ••• HEATING ELEMENT 2000W - 230V Ø30X300 mm
	<b>PASTA COOKER:</b> CP-74ET, CP-78ET
<b>Código fabricante / Manufacturer Code</b> 53.7.0211.00	

	Referencia Code <b>19726</b> ORIGINAL
	RESISTENCIA 2000W - 230V Ø30x300 mm CON VAINA PARA TERMOSTATO
	<b>CUECE PASTAS:</b> CP-74ET, CP-78ET ••• HEATING ELEMENT 2000W - 230V Ø30x300 mm WITH COVER FOR THERMOSTAT
	<b>PASTA COOKER:</b> CP-74ET, CP-78ET
<b>Código fabricante / Manufacturer Code</b> 53.7.0212.00	

## LOTUS

	Referencia Code <b>19727</b> ORIGINAL
	RESISTENCIA 3500W - 230V Ø30X475 mm
	<b>CUECE PASTAS:</b> CP-94ET, CP-78ET ••• HEATING ELEMENT 3500W - 230V Ø30X475 mm
	<b>PASTA COOKER:</b> CP-94ET, CP-78ET
<b>Código fabricante / Manufacturer Code</b> 53.7.0242.00	

	Referencia Code <b>19728</b> ORIGINAL
	RESISTENCIA 3500W - 230V Ø30X475 mm CON VAINA PARA TERMOSTATO
	<b>CUECE PASTAS:</b> CP-94ET, CP-78ET ••• HEATING ELEMENT 3500W - 230V Ø30X475 mm WITH COVER FOR THERMOSTAT
	<b>PASTA COOKER:</b> CP-94ET, CP-78ET
<b>Código fabricante / Manufacturer Code</b> 53.7.0242.00	

## MARENO

	Referencia Code <b>19899</b> ORIGINAL
	RESISTENCIA 4500W - 230V 355X218X25 mm
	<b>CUECE PASTAS:</b> CPE-60 (1ª serie) ••• HEATING ELEMENT 4500W - 230V 355X218X25 mm
	<b>PASTA COOKER:</b> CPE-60 (1st series)
<b>Código fabricante / Manufacturer Code</b> 10.37301200	

	Referencia Code <b>19902</b> ORIGINAL
	RESISTENCIA 5670W - 230V 292X225 mm / M10X1
	<b>CUECE PASTAS:</b> CP70-4E, PC7-4E ••• HEATING ELEMENT 5670W - 230V 292X225 mm / M10X1
	<b>PASTA COOKER:</b> CP70-4E, PC7-4E
<b>Código fabricante / Manufacturer Code</b> 1870000	

# RESISTENCIAS CUECE PASTAS / PASTA COOKER HEATING ELEMENTS

## MARENO



\*CÓDIGO JUNTA / GASKET CODE  
90772

Referencia  
Code **19903** ORIGINAL

RESISTENCIA  
8500W - 230V  
410X220 mm / M10X1

**CUECE PASTAS:** CP9-2E/4E, CP9-2E/2,  
CP9-4E/2, PC9-4E/8E

HEATING ELEMENT  
8500W - 230V  
410X220 mm / M10X1

**PASTA COOKER:** CP9-2E/4E, CP9-2E/2,  
CP9-4E/2, PC9-4E/8E

Código fabricante / Manufacturer Code **1814213**



\*CÓDIGO JUNTA / GASKET CODE  
90772

Referencia  
Code **19900** ORIGINAL

RESISTENCIA  
9000W - 230V  
245X320X25 mm

**CUECE PASTAS:** CPE-60 (2ª serie)

• • •

HEATING ELEMENT  
9000W - 230V  
245X320X25 mm

**PASTA COOKER:** CPE-60 (2nd series)

Código fabricante / Manufacturer Code **10.37305800**

## MODULAR



\*CÓDIGO JUNTA / GASKET CODE  
1248

Referencia  
Code **20028** ORIGINAL

RESISTENCIA  
3000W - 230V  
303X170 mm / ROSCA 1/8"

**CUECE PASTAS:** 60/\_CPE

HEATING ELEMENT  
3000W - 230V  
303X170 mm / 1/8" THREAD

**PASTA COOKER:** 60/\_CPE

Código fabricante / Manufacturer Code **665.032.00**



\*CÓDIGO JUNTA / GASKET CODE  
16601

Referencia  
Code **20029** ORIGINAL

RESISTENCIA  
3800W - 230V  
250X41X34 mm / ROSCA 1/8"

**CUECE PASTAS:** 70/\_CPG, 90/\_CPG

HEATING ELEMENT  
3800W - 230V  
250X41X34 mm / 1/8" THREAD

**PASTA COOKER:** 70/\_CPG, 90/\_CPG

Código fabricante / Manufacturer Code **465.000.00**

## MBM



\*CÓDIGO JUNTA / GASKET CODE  
1248

Referencia  
Code **22017** ORIGINAL

RESISTENCIA  
1850W - 230V  
279X48X29 mm / M16X1.5

**CUECE PASTAS:** EC47

• • •

HEATING ELEMENT  
1850W - 230V  
279X48X29 mm / M16X1.5

**PASTA COOKER:** EC47

Código fabricante / Manufacturer Code **RTCU700283**



\*CÓDIGO JUNTA / GASKET CODE  
1248

Referencia  
Code **22014** ORIGINAL

RESISTENCIA  
3000W - 230V  
264X58X28 mm / M16X1.5

**CUECE PASTAS:** EC66, EC77

• • •

HEATING ELEMENT  
3000W - 230V  
264X58X28 mm / M16X1.5

**PASTA COOKER:** EC66, EC77

Código fabricante / Manufacturer Code **RTCU700284**

## OLIS



\*CÓDIGO JUNTA / GASKET CODE  
1248

Referencia  
Code **19551** ORIGINAL

RESISTENCIA  
2520W - 230V  
452X66 mm / ROSCA 1/4"

**CUECE PASTAS:** SERIE 900

HEATING ELEMENT  
2520W - 230V  
452X66 mm / 1/4" THREAD

**PASTA COOKER:** SERIES 900

Código fabricante / Manufacturer Code **4185326002064**



\*CÓDIGO JUNTA / GASKET CODE  
1248

Referencia  
Code **20207** ORIGINAL

RESISTENCIA  
7500W - 230V  
300X237 mm / M14X1

**CUECE PASTAS:** 40SECP

HEATING ELEMENT  
7500W - 230V  
300X237 mm / M14X1

**PASTA COOKER:** 40SECP

Código fabricante / Manufacturer Code **8218100**

# RESISTENCIAS CUECE PASTAS / PASTA COOKER HEATING ELEMENTS

## OLIS



Referencia Code **89612** ORIGINAL

RESISTENCIA  
9000W - 230V  
480X34X52 mm

**CUECE PASTAS:** 92/04CPE, 94/04CPE

• • •

HEATING ELEMENT  
9000W - 230V  
480X34X52 mm

**PASTA COOKER:** 92/04CPE, 94/04CPE

\*CÓDIGO JUNTA / GASKET CODE  
19257

Código fabricante / Manufacturer Code **6A037220**

## TECNOINOX

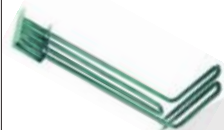

Referencia Code **20157** ORIGINAL

RESISTENCIA  
1600W - 230V  
368X75X170 mm

**CUECE PASTAS:** CP35E (desde 09/2003), CP E7

• • •

HEATING ELEMENT  
1600W - 230V  
368X75X170 mm

**PASTA COOKER:** CP35E (from 09/2003), CP E7

Código fabricante / Manufacturer Code **01250**

## ZANUSSI

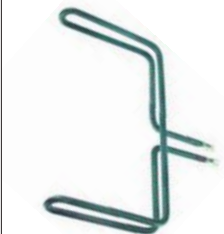

Referencia Code **22022** ORIGINAL

RESISTENCIA  
1000W - 230V  
245X290 mm

**CUECE PASTAS:** PCP/E1S, PCP/E2D

• • •

HEATING ELEMENT  
1000W - 230V  
245X290 mm

**PASTA COOKER:** PCP/E1S, PCP/E2D

Código fabricante / Manufacturer Code **A5492**

## ZANUSSI



Referencia Code **22019** ORIGINAL

RESISTENCIA  
1450W - 230V  
507X58 mm

**CUECE PASTAS:** RCP/E700, MCP/E700, MCP/E25, PCPE710, HCP/E400 (desde 01.'90), HCP/E800 (desde 01.'90)

• • •

HEATING ELEMENT  
1450W - 230V  
507X58 mm

**PASTA COOKER:** RCP/E700, MCP/E700, MCP/E25, PCPE710, HCP/E400 (from 01.'90), HCP/E800 (from 01.'90)

Código fabricante / Manufacturer Code **56906**



Referencia Code **22021** ORIGINAL

RESISTENCIA  
1650W - 230V  
500X54 mm

**CUECE PASTAS:** HCP/E400 (desde 01.'90), HCP/E800 (desde 01.'90), MCP/E25H, PCPE720

• • •

HEATING ELEMENT  
1650W - 230V  
500X54 mm

**PASTA COOKER:** HCP/E400 (from 01.'90), HCP/E800 (from 01.'90), MCP/E25H, PCPE720

Código fabricante / Manufacturer Code **06853**



Referencia Code **22024** ORIGINAL

RESISTENCIA  
3000W - 230V  
255X38X26 mm

**CUECE PASTAS:** MCP/G, HCP/G

• • •

HEATING ELEMENT  
3000W - 230V  
255X38X26 mm

**PASTA COOKER:** MCP/G, HCP/G

\*CÓDIGO JUNTA / GASKET CODE  
19257

Código fabricante / Manufacturer Code **066109**

## RESISTENCIAS CHURRERA CHURROS MACHINE H. ELEMENTS

### REPAGAS



Referencia  
Code **50671** ORIGINAL

RESISTENCIA  
BLINDADA  
THERMOSTATO 20°C - 195°C  
THERMOSTATO SEGURIDAD 10 kW

CHURRERA



HEATING ELEMENT  
REINFORCED  
THERMOSTAT 20°C - 195°C  
SAFETY THERMOSTAT 10 kW

CHURRO MACHINE

Código fabricante / Manufacturer Code

RS-10

## RESISTENCIAS FERMENTADORA FERMENTATOR HEATING ELEMENTS

### UNOX



Referencia  
Code **47250** ORIGINAL

RESISTENCIA  
1050W - 230V  
464X345 mm

FERMENTADORA: XL041, XL051, XL091,  
XL503



HEATING ELEMENT  
1050W - 230V  
464X345 mm

FERMENTATOR: XL041, XL01, XL091,  
XL503

Código fabricante / Manufacturer Code

KRS057

## RESISTENCIAS FREIDORA / FRYER HEATING ELEMENTS

### AMBACH



Referencia  
Code **19301** ORIGINAL

RESISTENCIA  
7500W - 400V  
335X135X340 mm

FREIDORA: EF1-40 ECO, EF2-40 ECO,  
EF1-45, EF2-45



HEATING ELEMENT  
7500W - 400V  
335X135X340 mm

FRYER: EF1-40 ECO, EF2-40 ECO, EF1-45,  
EF2-45

Código fabricante / Manufacturer Code

5060811194

### ANGELO PO



Referencia  
Code **19391** ORIGINAL

RESISTENCIA  
4700W - 230V  
480X90X230 mm / ROSCA 1/4"

FREIDORA: 70FE1, 70FE1B, 71FE2, 71FE2B



HEATING ELEMENT  
4700W - 230V  
480X90X230 mm / 1/4" THREAD

FRYER: 70FE1, 70FE1B, 71FE2, 71FE2B

\*CÓDIGO JUNTA / GASKET CODE  
1248

Código fabricante / Manufacturer Code

3261181

### ANGELO PO



Referencia  
Code **19390** ORIGINAL

RESISTENCIA  
2050W - 230V  
275X55X255 mm / ROSCA 1/4"

FREIDORA: 030FE, 030FE1, 030FE1B,  
30FES, 30FES2, 30FES2B, 70FES, 70FES2,  
70FES2B, 91FE28, 91FE28B



HEATING ELEMENT  
2050W - 230V  
275X55X255 mm / 1/4" THREAD

FRYER: 030FE, 030FE1, 030FE1B, 30FES,  
30FES2, 30FES2B, 70FES, 70FES2, 70FES2B,  
91FE28, 91FE28B

\*CÓDIGO JUNTA / GASKET CODE  
1248

Código fabricante / Manufacturer Code

3261241

Código fabricante / Manufacturer Code

Referencia  
Code **19392** ORIGINAL

RESISTENCIA  
18000W - 230V  
380X270 mm

FREIDORA: DELTA, OMEGA



HEATING ELEMENT  
18000W - 230V  
380X270 mm

FRYER: DELTA, OMEGA

\*CÓDIGO JUNTA / GASKET CODE  
19744

Código fabricante / Manufacturer Code

3262400

# RESISTENCIAS FREIDORA / FRYER HEATING ELEMENTS

## BARON

	Referencia Code <b>19429</b> ORIGINAL
	RESISTENCIA 6800W - 230/400V 300X110 mm / M54X1.5
	<b>FREIDORA:</b> SERIE 700, SERIE 900 • • • <b>HEATING ELEMENT</b> 6800W - 230/400V 300X110 mm / M54X1.5
*CÓDIGO JUNTA / GASKET CODE 22319 / 22313	<b>FRYER:</b> SERIES 700, SERIES 900
<b>Código fabricante / Manufacturer Code</b> 85326002136	

	Referencia Code <b>19432</b> ORIGINAL
	RESISTENCIA 9000W - 230/400V 310X205 mm
	<b>FREIDORA:</b> SERIE 600, SERIE 900 • • • <b>HEATING ELEMENT</b> 9000W - 230/400V 310X205 mm
*CÓDIGO JUNTA / GASKET CODE 22319 / 22313	<b>FRYER:</b> SERIES 600, SERIES 900
<b>Código fabricante / Manufacturer Code</b> 826620130	

	Referencia Code <b>19542</b> ORIGINAL
	RESISTENCIA 10200W - 230/400V 300X180 mm / M54X1.5
	<b>FREIDORA:</b> SERIE 700, SERIE 900 • • • <b>HEATING ELEMENT</b> 10200W - 230/400V 300X180 mm / M54X1.5
*CÓDIGO JUNTA / GASKET CODE 19928 / 22313	<b>FRYER:</b> SERIES 700, SERIES 900
<b>Código fabricante / Manufacturer Code</b> 85326002137	

## BARON

	Referencia Code <b>19431</b> ORIGINAL
	RESISTENCIA 15000W - 400V 305X290 mm / M54X1.5
	<b>FREIDORA:</b> SERIE 700, SERIE 900 • • • <b>HEATING ELEMENT</b> 15000W - 400V 305X290 mm / M54X1.5
*CÓDIGO JUNTA / GASKET CODE 22319 / 22313	<b>FRYER:</b> SERIES 700, SERIES 900
<b>Código fabricante / Manufacturer Code</b> 85326002138	

	Referencia Code <b>88951</b> ORIGINAL
	RESISTENCIA 18000W - 230V 450X243 mm
	<b>FREIDORA</b> • • • <b>HEATING ELEMENT</b> 18000W - 230V 450X243 mm
	<b>FRYER</b>
<b>Código fabricante / Manufacturer Code</b> 9000519	

## BECKERS

	Referencia Code <b>84292</b> ORIGINAL
	RESISTENCIA 2000W - 230V 240X115X150 mm
	<b>FREIDORA:</b> 4 LITROS • • • <b>HEATING ELEMENT</b> 2000W - 230V 240X115X150 mm
*CÓDIGO JUNTA / GASKET CODE 1248	<b>FRYER:</b> 4 LITERS
<b>Código fabricante / Manufacturer Code</b> FRI/0430	

	Referencia Code <b>84294</b> ORIGINAL
	RESISTENCIA 2000W - 230V CON CABEZAL
	<b>FREIDORA:</b> 4 LITROS • • • <b>HEATING ELEMENT</b> 2000W - 230V WITH CONTROL PANEL
	<b>FRYER:</b> 4 LITERS
<b>Código fabricante / Manufacturer Code</b> FRI/03624	

# RESISTENCIAS FREIDORA / FRYER HEATING ELEMENTS

## BECKERS



Referencia Code **84293** ORIGINAL

RESISTENCIA  
3000W - 230V  
245X165X155 mm  
CON CABEZAL

FREIDORA: 6 LITROS

HEATING ELEMENT  
3000W - 230V  
245X165X155 mm  
WITH CONTROL PANEL

FRYER: 6 LITERS

Código fabricante / Manufacturer Code

FRI/03625

## BECKERS



Referencia Code **48630** ORIGINAL

RESISTENCIA  
5000W - 230V

FREIDORA: FBR 13+13

HEATING ELEMENT  
5000W - 230V

FRYER: FBR 13+13

\*CÓDIGO JUNTA / GASKET CODE  
1248

Código fabricante / Manufacturer Code

FRI/0434

Referencia Code **84297** ORIGINAL

RESISTENCIA  
3500W - 230V  
CON CABEZAL

FREIDORA: FBR 6 LITROS

HEATING ELEMENT  
3500W - 230V  
WITH CONTROL PANEL

FRYER: FBR 6 LITERS



Código fabricante / Manufacturer Code

FRI/03627

Referencia Code **84296** ORIGINAL

RESISTENCIA  
3500W - 230V  
220X140X200 mm

FREIDORA: 9 LITROS

HEATING ELEMENT  
3500W - 230V  
220X140X200 mm

FRYER: 9 LITERS



\*CÓDIGO JUNTA / GASKET CODE  
1248

Código fabricante / Manufacturer Code

FRI/0433

## BERTO'S

Referencia Code **22291** ORIGINAL

RESISTENCIA  
1800W - 230V  
270X137X150 mm / M14X1.5

FREIDORA: ELT4B, ELT4+4B

HEATING ELEMENT  
1800W - 230V  
270X137X150 mm / M14X1.5

FRYER: ELT4B, ELT4+4B



Código fabricante / Manufacturer Code

33024600

Referencia Code **22292** ORIGINAL

RESISTENCIA  
2700W - 230V  
240X208X125 mm / ROSCA 1/4"

FREIDORA: ELT8B, ELT8+8B

HEATING ELEMENT  
2700W - 230V  
240X208X125 mm / 1/4" THREAD

FRYER: ELT8B, ELT8+8B



\*CÓDIGO JUNTA / GASKET CODE  
1248

Código fabricante / Manufacturer Code

33024700

Referencia Code **85455** ORIGINAL

RESISTENCIA  
3500W - 230V

FREIDORA: FBR 9 LITROS

HEATING ELEMENT  
3500W - 230V

FRYER: FBR 9 LITERS



\*CÓDIGO JUNTA / GASKET CODE  
1248

Código fabricante / Manufacturer Code

FRI/0433

Referencia Code **22294** ORIGINAL

RESISTENCIA  
3100W - 230V  
270X215X131 mm / ROSCA 1/4"

FREIDORA: ELT10B, ELT10+10B, ELT12\_, ELT12\_+12B\_

HEATING ELEMENT  
3100W - 230V  
270X215X131 mm / 1/4" THREAD

FRYER: ELT10B, ELT10+10B, ELT12\_, ELT12\_+12B\_



\*CÓDIGO JUNTA / GASKET CODE  
1248

Código fabricante / Manufacturer Code

33024800

# RESISTENCIAS FREIDORA / FRYER HEATING ELEMENTS

## BERTO'S



Referencia Code **22293** ORIGINAL

RESISTENCIA  
3450W - 230V  
260X200X167 mm / ROSCA 1/4"

FREIDORA: ELT8B, ELT8+8B

HEATING ELEMENT  
3450W - 230V  
260X200X167 mm / 1/4" THREAD

FRYER: ELT8B, ELT8+8B

Código fabricante / Manufacturer Code **33024900**



Referencia Code **22295** ORIGINAL

RESISTENCIA  
3500W - 230V  
290X190X153 mm / ROSCA 1/4"

FREIDORA: ELT10B, ELT10+10B, ELT12\_,  
ELT12\_+12B\_

HEATING ELEMENT  
3500W - 230V  
290X190X153 mm / 1/4" THREAD

FRYER: ELT10B, ELT10+10B, ELT12\_,  
ELT12\_+12B\_

\*CÓDIGO JUNTA / GASKET CODE  
1248

Código fabricante / Manufacturer Code **33025600**



Referencia Code **22296** ORIGINAL

RESISTENCIA  
5000W - 230V  
245X200X170 mm

FREIDORA: ELT10B-E, ELT10+10B-E

HEATING ELEMENT  
5000W - 230V  
245X200X170 mm

FRYER: ELT10B-E, ELT10+10B-E

Código fabricante / Manufacturer Code **33026600**



Referencia Code **19570** ORIGINAL

RESISTENCIA  
6000W - 230V  
300X182X252 mm

FREIDORA: E10B4, E10+10MB6

HEATING ELEMENT  
6000W - 230V  
300X182X252 mm

FRYER: E10B4, E10+10MB6

Código fabricante / Manufacturer Code **22016200**

## BERTO'S



Referencia Code **22297** ORIGINAL

RESISTENCIA  
6000W - 230V  
280X202X170 mm

FREIDORA: ELTB12/M

HEATING ELEMENT  
6000W - 230V  
280X202X170 mm

FRYER: ELTB12/M

Código fabricante / Manufacturer Code **33026700**



Referencia Code **22298** ORIGINAL

RESISTENCIA  
7000W - 230V  
300X240X200 mm

FREIDORA: ELTB15/M

HEATING ELEMENT  
7000W - 230V  
300X240X200 mm

FRYER: ELTB15/M

Código fabricante / Manufacturer Code **33026500**



Referencia Code **22299** ORIGINAL

RESISTENCIA  
9000W - 230V  
300X240X200 mm

FREIDORA: ELTB18/M

HEATING ELEMENT  
9000W - 230V  
300X240X200 mm

FRYER: ELTB18/M

Código fabricante / Manufacturer Code **33026900**

## BUFFALO



Referencia Code **87366** ORIGINAL

RESISTENCIA  
3000W - 230V

FREIDORA: L484

HEATING ELEMENT  
3000W - 230V

FRYER: L484

Código fabricante / Manufacturer Code **N119**

# RESISTENCIAS FREIDORA / FRYER HEATING ELEMENTS

## CRYSTALLINE

	Referencia Code	<b>19328</b>	STANDARD
	RESISTENCIA 3300W - 230V		
	FREIDORA:	CF-6	••••
	HEATING ELEMENT 3300W - 230V		
FRYER: CF-6			
Código fabricante / Manufacturer Code		378	

	Referencia Code	<b>19329</b>	STANDARD
	RESISTENCIA 3300W - 230V		
	FREIDORA:	CF-9	••••
	HEATING ELEMENT 3300W - 230V		
FRYER: CF-9			
Código fabricante / Manufacturer Code		379	

	Referencia Code	<b>19330</b>	STANDARD
	RESISTENCIA 4950W - 400V		
	FREIDORA:	CF-9	••••
	HEATING ELEMENT 4950W - 400V		
FRYER: CF-9			
Código fabricante / Manufacturer Code		380	

	Referencia Code	<b>19331</b>	STANDARD
	RESISTENCIA 6600W - 230/400V		
	FREIDORA:	CF-12	••••
	HEATING ELEMENT 6600W - 230/400V		
FRYER: CF-12			
Código fabricante / Manufacturer Code		2430	

## DIFRI

	Referencia Code	<b>47972</b>	ORIGINAL
	RESISTENCIA 3500W - 230V		
	FREIDORA:	FMI	••••
	HEATING ELEMENT 3500W - 230V		
FRYER: FMI			
Código fabricante / Manufacturer Code		29692010	

## DOSILET

	Referencia Code	<b>5669</b>	STANDARD
	RESISTENCIA 3000W - 230V 195X230X160 mm		
	FREIDORA:	F6	••••
	HEATING ELEMENT 3000W - 230V 195X230X160 mm		
FRYER: F6			
Código fabricante / Manufacturer Code		93001	

\*CÓDIGO JUNTA / GASKET CODE  
1248

	Referencia Code	<b>15847</b>	ORIGINAL
	RESISTENCIA 3000W - 230V CON CABEZAL		
	FREIDORA:	6, 7, 8 LITROS	••••
	HEATING ELEMENT 3000W - 230V WITH CONTROL PANEL		
FRYER: 6, 7, 8 LITERS			
Código fabricante / Manufacturer Code		93011	

	Referencia Code	<b>5671</b>	STANDARD
	RESISTENCIA 3000W - 230V		
	FREIDORA:	6, 7, 8 LITROS	••••
	HEATING ELEMENT 3000W - 230V		
FRYER: 6, 7, 8 LITERS			
Código fabricante / Manufacturer Code		93003	

\*CÓDIGO JUNTA / GASKET CODE  
1248



# RESISTENCIAS FREIDORA / FRYER HEATING ELEMENTS

## DOSILET



Referencia Code **47596** ORIGINAL

RESISTENCIA  
4500W - 230V  
CON CABEZAL

FREIDORA: 7, 8, 10 LITROS

HEATING ELEMENT  
4500W - 230V  
WITH CONTROL PANEL

FRYER: 7, 8, 10 LITERS

Código fabricante / Manufacturer Code **93013**

Referencia Code **23369** ORIGINAL



RESISTENCIA  
6000W - 230V

FREIDORA: FE13

HEATING ELEMENT  
6000W - 230V

FRYER: FE13

\*CÓDIGO JUNTA / GASKET CODE  
1248

Código fabricante / Manufacturer Code **93004**

## EDESA



Referencia Code **9447** ORIGINAL

RESISTENCIA  
1500W - 230V

FREIDORA: FE-6

HEATING ELEMENT  
1500W - 230V

FRYER: FE-6

Código fabricante / Manufacturer Code **K008841004**

## ELETTROBAR



Referencia Code **16465** ORIGINAL

RESISTENCIA  
10950W - 380V  
415X128X240 mm

FREIDORA: ME20

HEATING ELEMENT  
10950W - 380V  
415X128X240 mm

FRYER: ME20

Código fabricante / Manufacturer Code **230074**

## ELETTROBAR



Referencia Code **85440** ORIGINAL

RESISTENCIA  
3300W - 230V  
249X128X210 mm

FREIDORA: FR16

HEATING ELEMENT  
3300W - 230V  
249X128X210 mm

FRYER: FR16

Código fabricante / Manufacturer Code **230069**

## ELFRAMO



Referencia Code **19495** ORIGINAL

RESISTENCIA  
1260W - 230V  
320X48X220 mm / ROSCA 1/4"

FREIDORA: EB8, EB18

HEATING ELEMENT  
1260W - 230V  
320X48X220 mm / 1/4" THREAD

FRYER: EB8, EB18

Código fabricante / Manufacturer Code **00033130**

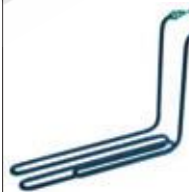

Referencia Code **19497** ORIGINAL

RESISTENCIA  
2000W - 230V  
315X74X250 mm / ROSCA 1/4"

FREIDORA: EB12 (6kW), EM12

HEATING ELEMENT  
2000W - 230V  
315X74X250 mm / 1/4" THREAD

FRYER: EB12, EM12

Código fabricante / Manufacturer Code **00033141**



Referencia Code **19494** ORIGINAL

RESISTENCIA  
2800W - 230V  
280X160X185 mm / ROSCA 1/4"

FREIDORA: EBG

HEATING ELEMENT  
2800W - 230V  
280X160X185 mm / 1/4" THREAD

FRYER: EBG

Código fabricante / Manufacturer Code **00033120**

# RESISTENCIAS FREIDORA / FRYER HEATING ELEMENTS

## ELFRAMO



Referencia Code **19498** ORIGINAL

RESISTENCIA  
3000W - 230V  
297X86X243 mm / ROSCA 1/4"

**FREIDORA:** EB12 (9kW), EM12

HEATING ELEMENT  
3000W - 230V  
297X86X243 mm / 1/4" THREAD

**FRYER:** EB12 (9kW), EM12

\*CÓDIGO JUNTA / GASKET CODE  
1248

Código fabricante / Manufacturer Code **00033142**



Referencia Code **19499** ORIGINAL

RESISTENCIA  
3333W - 230V  
395X85X245 mm / ROSCA 1/4"

**FREIDORA:** EM20 (8,4kW, 9,9kW)

HEATING ELEMENT  
3333W - 230V  
395X85X245 mm / 1/4" THREAD

**FRYER:** EM20 (8,4kW, 9,9kW)

\*CÓDIGO JUNTA / GASKET CODE  
960

Código fabricante / Manufacturer Code **00033150, 00033151**



Referencia Code **19500** ORIGINAL

RESISTENCIA  
5500W - 230V  
250X60X250 mm / M14X1.5

**FREIDORA:** EM20 (15kW)

HEATING ELEMENT  
5500W - 230V  
250X60X250 mm / M14X1.5

**FRYER:** EM20 (15kW)

Código fabricante / Manufacturer Code **00033154, 00033155**

## EMMEPI



Referencia Code **19539** ORIGINAL

RESISTENCIA  
1333W - 230V  
286X40X27 mm / M12X1

**FREIDORA:** FR\_ EGT

HEATING ELEMENT  
1333W - 230V  
286X40X27 mm / M12X1

**FRYER:** FR\_ EGT

\*CÓDIGO JUNTA / GASKET CODE  
1248

Código fabricante / Manufacturer Code **808620**

## EMMEPI



Referencia Code **19540** ORIGINAL

RESISTENCIA  
3300W - 230V  
285X74X42 mm / M12X1

**FREIDORA:** FR\_ EGM

HEATING ELEMENT  
3300W - 230V  
285X74X42 mm / M12X1

**FRYER:** FR\_ EGM

\*CÓDIGO JUNTA / GASKET CODE  
1091

Código fabricante / Manufacturer Code **809460**



Referencia Code **19429** ORIGINAL

RESISTENCIA  
6800W - 230V  
300X110X34 mm / M54X1.5

**FREIDORA:** FR\_ E, SFR\_ E1, FR\_ EB1, EFR\_ EZV

HEATING ELEMENT  
6800W - 230V  
300X110X34 mm / M54X1.5

**FRYER:** FR\_ E, SFR\_ E1, FR\_ EB1, EFR\_ EZV

\*CÓDIGO JUNTA / GASKET CODE  
22313 / 22319

Código fabricante / Manufacturer Code **808689**



Referencia Code **19542** ORIGINAL

RESISTENCIA  
10200W - 400V  
300X180X33 mm / M54X1.5

**FREIDORA:** FR\_ EB, SFR\_ E1, EFR\_ EB

HEATING ELEMENT  
10200W - 400V  
300X180X33 mm / M54X1.5

**FRYER:** FR\_ EB, SFR\_ E1, EFR\_ EB

\*CÓDIGO JUNTA / GASKET CODE  
22313 / 22319

Código fabricante / Manufacturer Code **808256**



Referencia Code **19431** ORIGINAL

RESISTENCIA  
15000W - 400V  
305X290X34 mm / M54X1.5

**FREIDORA:** EFR9\_ EB

HEATING ELEMENT  
15000W - 400V  
305X290X34 mm / M54X1.5

**FRYER:** EFR9\_ EB

\*CÓDIGO JUNTA / GASKET CODE  
22313 / 22319

Código fabricante / Manufacturer Code **808046**

# RESISTENCIAS FREIDORA / FRYER HEATING ELEMENTS

## EURAST



Referencia Code **87604** ORIGINAL

RESISTENCIA  
4500W - 230V  
CON CABEZAL

FREIDORA: 20 LITROS

HEATING ELEMENT  
4500W - 230V  
WITH CONTROL PANEL

FRYER: 20 LITERS

Código fabricante / Manufacturer Code **625M0019**

## EUROFRED



Referencia Code **47251** ORIGINAL

RESISTENCIA  
8250W - 230/380V  
310X240 mm

FREIDORA

HEATING ELEMENT  
8250W - 230V  
310X240 mm

FRYER

Código fabricante / Manufacturer Code ---

## FAGOR

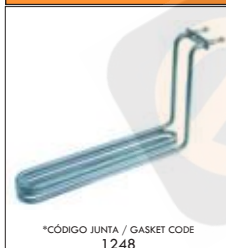

Referencia Code **9447** ORIGINAL

RESISTENCIA  
1500W - 230V  
300X50X180 mm

FREIDORA: FE6

HEATING ELEMENT  
1500W - 230V  
300X50X180 mm

FRYER: FE6

Código fabricante / Manufacturer Code **X363005, X363023**



Referencia Code **7907** STANDARD

RESISTENCIA  
2000W - 230V  
310X50X180 mm

FREIDORA: FE8

HEATING ELEMENT  
2000W - 230V  
310X50X180 mm

FRYER: FE8

## FAGOR



Referencia Code **16820** ORIGINAL

RESISTENCIA  
2000W - 230V  
310X50X180 mm

FREIDORA: FE8

HEATING ELEMENT  
2000W - 230V  
310X50X180 mm

FRYER: FE8

Código fabricante / Manufacturer Code **X373022000**



Referencia Code **9446** STANDARD

RESISTENCIA  
3000W - 230V  
303X45X190 mm

FREIDORA: FE4

HEATING ELEMENT  
3000W - 230V  
303X45X190 mm

FRYER: FE4

\*CÓDIGO JUNTA / GASKET CODE  
1248

Código fabricante / Manufacturer Code **X353024000**



Referencia Code **16818** ORIGINAL

RESISTENCIA  
3000W - 230V  
303X45X190 mm

FREIDORA: FE4

HEATING ELEMENT  
3000W - 230V  
303X45X190 mm

FRYER: FE4

Código fabricante / Manufacturer Code **X353024000**



Referencia Code **16821** ORIGINAL

RESISTENCIA  
3000W - 230V  
335X47X226 mm

FREIDORA: FE18

HEATING ELEMENT  
3000W - 230V  
335X47X226 mm

FRYER: FE18

Código fabricante / Manufacturer Code **X383020000**

# RESISTENCIAS FREIDORA / FRYER HEATING ELEMENTS

## FAGOR

Referencia **16815** ORIGINAL  
Code

RESISTENCIA  
DERECHA / CENTRAL  
4000W - 230V  
300X85X300 mm / M14X1.25

FREIDORA: FE710

HEATING ELEMENT  
RIGHT / CENTRAL  
4000W - 230V  
300X85X300 mm / M14X1.25

FRYER: FE710



Código fabricante / Manufacturer Code **X323009000**

Referencia **16816** ORIGINAL  
Code

RESISTENCIA  
IZQUIERDA / CENTRAL  
4000W - 230V  
285X90X290 mm / M14X1.25

FREIDORA: FE710

HEATING ELEMENT  
LEFT / CENTRAL  
4000W - 230V  
285X90X290 mm / M14X1.25

FRYER: FE710



Código fabricante / Manufacturer Code **X323002000**

Referencia **16823** ORIGINAL  
Code

RESISTENCIA  
4250W - 230V  
380X104X230 mm

FREIDORA: FE25

HEATING ELEMENT  
4250W - 230V  
380X104X230 mm

FRYER: FE25



Código fabricante / Manufacturer Code **X393021000**

Referencia **16811** ORIGINAL  
Code

RESISTENCIA  
6000W - 230V  
380X90X355 mm

FREIDORA: FE920, FE910, FE910S

HEATING ELEMENT  
4250W - 230V  
380X90X355 mm

FRYER: FE920, FE910, FE910S



Código fabricante / Manufacturer Code **X183068000**

## FAGOR

Referencia **20266** ORIGINAL  
Code

RESISTENCIA  
6000W - 230V  
415X100X450 mm / M15X1.5

FREIDORA: FE920

HEATING ELEMENT  
6000W - 230V  
415X100X450 mm / M15X1.5

FRYER: FE920



\*CÓDIGO JUNTA / GASKET CODE  
90806

Código fabricante / Manufacturer Code **X183000000**

## FRANKE

Referencia **48400** ORIGINAL  
Code

RESISTENCIA  
7500W - 230V  
CON CABEZAL

FREIDORA: FFS-21, FFS-41, FFS-42

HEATING ELEMENT  
7500W - 230V  
WITH CONTROL PANEL

FRYER: FFS-21, FFS-41, FFS-42

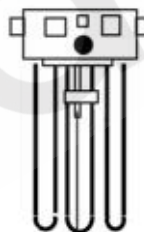

Código fabricante / Manufacturer Code **5395389**

## FRI FRI

Referencia **22306** ORIGINAL  
Code

RESISTENCIA  
1500W - 230V  
289X50X178 mm

FREIDORA: D6

HEATING ELEMENT  
1500W - 230V  
289X50X178 mm

FRYER: D6





Código fabricante / Manufacturer Code **400532, 400360**

# RESISTENCIAS FREIDORA / FRYER HEATING ELEMENTS

## FRI FRI

	Referencia Code	<b>22307</b> ORIGINAL
		RESISTENCIA 2000W - 230V 302X51X177 mm
	FREIDORA:	D8 • • •
		HEATING ELEMENT 2000W - 230V 302X51X177 mm
	FRYER:	D8
Código fabricante / Manufacturer Code		400533, 400361

	Referencia Code	<b>22308</b> ORIGINAL
		RESISTENCIA 2300W - 230V 280X62X180 mm
	FREIDORA:	FT4, FT4+4, FT6, FT8 • • •
		HEATING ELEMENT 2300W - 230V 280X62X180 mm
	FRYER:	FT4, FT4+4, FT6, FT8
Código fabricante / Manufacturer Code		100947

	Referencia Code	<b>22305</b> ORIGINAL
		RESISTENCIA 3000W - 230V 298X51X190 mm
	FREIDORA:	D4 • • •
		HEATING ELEMENT 3000W - 230V 298X51X190 mm
	FRYER:	D4
Código fabricante / Manufacturer Code		400534, 400362

	Referencia Code	<b>22303</b> ORIGINAL
		RESISTENCIA 3200W - 230V 295X127X162 mm
	FREIDORA:	ECO4, ECO4+4 • • •
		HEATING ELEMENT 3200W - 230V 295X127X162 mm
	FRYER:	ECO4, ECO4+4
Código fabricante / Manufacturer Code		300914

## FRI FRI

	Referencia Code	<b>22304</b> ORIGINAL
		RESISTENCIA 3200W - 230V 297X180X161 mm
	FREIDORA:	ECO6, ECO6+6 • • •
		HEATING ELEMENT 3200W - 230V 297X180X161 mm
	FRYER:	ECO6, ECO6+6
Código fabricante / Manufacturer Code		300915

	Referencia Code	<b>22309</b> ORIGINAL
		RESISTENCIA 3750W - 400V 284X203X164 mm
	FREIDORA:	215, 219, TF6 • • •
		HEATING ELEMENT 3750W - 400V 284X203X164 mm
	FRYER:	215, 219, TF6
Código fabricante / Manufacturer Code		21550015

	Referencia Code	<b>22310</b> ORIGINAL
		RESISTENCIA 7500W - 230V 310X130X295 mm
	FREIDORA:	FF21, FF41, FF42, FF_21, FF_41, FF_42 • • •
		HEATING ELEMENT 7500W - 230V 310X130X295 mm
	FRYER:	FF21, FF41, FF42, FF_21, FF_41, FF_42
Código fabricante / Manufacturer Code		600644, 101105

	Referencia Code	<b>22311</b> ORIGINAL
		RESISTENCIA 11400W - 230V 310X215X298 mm
	FREIDORA:	FF31, FFS31, FFE31, FFM31 • • •
		HEATING ELEMENT 11400W - 230V 310X215X298 mm
	FRYER:	FF31, FFS31, FFE31, FFM31
Código fabricante / Manufacturer Code		300950

# RESISTENCIAS FREIDORA / FRYER HEATING ELEMENTS

## GAY



Referencia Code **3252** ORIGINAL

RESISTENCIA  
1800W - 230V  
265X110X170 mm

FREIDORA: F4, F4+4

HEATING ELEMENT  
1800W - 230V  
265X110X170 mm

FRYER: F4, F4+4

Código fabricante / Manufacturer Code **12430060**



Referencia Code **85718** ORIGINAL

RESISTENCIA  
12000W - 230V  
280X225X32 mm  
MONTAJE IZQUIERDO

FREIDORA: CFE15

HEATING ELEMENT  
12000W - 230V  
280X225X32 mm  
LEFT ASSEMBLY

FRYER: CFE15

Código fabricante / Manufacturer Code **Y17000**



Referencia Code **19570** ORIGINAL

RESISTENCIA  
6000W - 230V  
300X182X252 mm

FREIDORA: SKF-E

HEATING ELEMENT  
6000W - 230V  
300X182X252 mm

FRYER: SKF-E

Código fabricante / Manufacturer Code **X46200**



Referencia Code **6872** ORIGINAL

RESISTENCIA  
2300W - 230V  
220X270X155 mm  
CON CABEZAL

FREIDORA: F8, F15

HEATING ELEMENT  
2300W - 230V  
220X270X155 mm  
WITH CONTROL PANEL

FRYER: F8, F15

Código fabricante / Manufacturer Code **76411164**



Referencia Code **3254** ORIGINAL

RESISTENCIA  
3500W - 230V  
305X220X155 mm

FREIDORA: F8, F15

HEATING ELEMENT  
3500W - 230V  
305X220X155 mm

FRYER: F8, F15

\*CÓDIGO JUNTA / GASKET CODE  
1248

Código fabricante / Manufacturer Code **12501100**



Referencia Code **14168** ORIGINAL

RESISTENCIA  
3500W - 230V  
CON CABEZAL

FREIDORA: F10

HEATING ELEMENT  
3500W - 230V  
WITH CONTROL PANEL

FRYER: F10

Código fabricante / Manufacturer Code **76411162**

## GIORIK



Referencia Code **19539** ORIGINAL

RESISTENCIA  
1333W - 230V  
286X40X27 mm

FREIDORA: FRE33, FRE63, FTR6T

HEATING ELEMENT  
1333W - 230V  
286X40X27 mm

FRYER: FRE33, FRE63, FTR6T

\*CÓDIGO JUNTA / GASKET CODE  
1248

Código fabricante / Manufacturer Code **6001139**



Referencia Code **19540** ORIGINAL

RESISTENCIA  
3300W - 230V  
285X74X42 mm

FREIDORA: FRE31, FRE61, FT6F

HEATING ELEMENT  
3300W - 230V  
285X74X42 mm

FRYER: FRE31, FRE61, FT6F

\*CÓDIGO JUNTA / GASKET CODE  
1091

Código fabricante / Manufacturer Code **6001138, 6001144**

# RESISTENCIAS FREIDORA / FRYER HEATING ELEMENTS

## GIORIK



\*CÓDIGO JUNTA / GASKET CODE  
22313 / 22319

Referencia  
Code **19429** ORIGINAL

RESISTENCIA  
6800W - 230V  
300X110X34 mm / M54X1.5

FREIDORA: 8 LITROS

HEATING ELEMENT  
6800W - 230V  
300X110X34 mm / M54X1.5

FRYER: 8 LITERS

Código fabricante / Manufacturer Code **6002136**



\*CÓDIGO JUNTA / GASKET CODE  
22313 / 19928

Referencia  
Code **19542** ORIGINAL

RESISTENCIA  
10200W - 230/400V  
300X180X33 mm / M54X1.5

FREIDORA: F15

HEATING ELEMENT  
10200W - 230/400V  
300X180X33 mm / M54X1.5

FRYER: F15

Código fabricante / Manufacturer Code **6002137**



\*CÓDIGO JUNTA / GASKET CODE  
22313 / 22319

Referencia  
Code **19431** ORIGINAL

RESISTENCIA  
15000W - 400V  
305X290X34 mm

FREIDORA

HEATING ELEMENT  
15000W - 400V  
305X290X34 mm

FRYER

Código fabricante / Manufacturer Code **6002138**

## INFRICO



Referencia  
Code **25222** ORIGINAL

RESISTENCIA  
3000W - 230V

FREIDORA: FR-6L

HEATING ELEMENT  
3000W - 230V

FRYER: FR-6L

Código fabricante / Manufacturer Code **2500X001**

## JEMI



Referencia  
Code **3125** ORIGINAL

RESISTENCIA  
2000W - 230V  
Ø214X125 mm

FREIDORA: J-4, N-85

HEATING ELEMENT  
2000W - 230V  
Ø214X125 mm

FRYER: J-4, N-85

Código fabricante / Manufacturer Code **2001003**



Referencia  
Code **20519** ORIGINAL

RESISTENCIA  
2050W - 230V  
370X60X290 mm

FREIDORA: FRE700

HEATING ELEMENT  
2050W - 230V  
370X60X290 mm

FRYER: FRE700

Código fabricante / Manufacturer Code **240029**



Referencia  
Code **50174** ORIGINAL

RESISTENCIA  
2050W - 230V  
305X50X250 mm

FREIDORA: FRE75

HEATING ELEMENT  
2050W - 230V  
305X50X250 mm

FRYER: FRE75

Código fabricante / Manufacturer Code **240033**



\*CÓDIGO JUNTA / GASKET CODE  
2166

Referencia  
Code **5720** ORIGINAL

RESISTENCIA  
2200W - 230V  
275X130X170 mm

FREIDORA: J3

HEATING ELEMENT  
2200W - 230V  
275X130X170 mm

FRYER: J3

Código fabricante / Manufacturer Code **2001110**

# RESISTENCIAS FREIDORA / FRYER HEATING ELEMENTS

## JEMI



Referencia Code **80387** ORIGINAL

RESISTENCIA  
2200W - 230V  
130X275X170 mm  
CON CABEZAL

**FREIDORA:** J-3

HEATING ELEMENT  
2200W - 230V  
130X275X170 mm  
WITH CONTROL PANEL

**FRYER:** J-3

Código fabricante / Manufacturer Code **8020020**



Referencia Code **3277** STANDARD

RESISTENCIA  
3200W - 230V  
350X190X130 mm

**FREIDORA:** J-6, N-10

HEATING ELEMENT  
3200W - 230V  
350X190X130 mm

**FRYER:** J-6, N-10

Código fabricante / Manufacturer Code **2001115**



Referencia Code **49568** ORIGINAL

RESISTENCIA  
3200W - 230V  
350X190X130 mm

**FREIDORA:** J-6, N-10

HEATING ELEMENT  
3200W - 230V  
350X190X130 mm

**FRYER:** J-6, N-10

Código fabricante / Manufacturer Code **2001083**



Referencia Code **5681** STANDARD

RESISTENCIA  
4000W - 230/380V

**FREIDORA:** J-11, N-18

HEATING ELEMENT  
4000W - 230/380V

**FRYER:** J-11, N-18

Código fabricante / Manufacturer Code **2001011**

## JEMI



Referencia Code **20388** ORIGINAL

RESISTENCIA  
4700W - 380V  
490X90X310 mm

**FREIDORA:** SERIE 900, SERIE 1000,  
SERIE 1300

HEATING ELEMENT  
4700W - 380V  
490X90X310 mm

**FRYER:** SERIES 900, SERIES 1000,  
SERIES 1300

Código fabricante / Manufacturer Code **240032**



Referencia Code **21255** ORIGINAL

RESISTENCIA  
4700W - 380V  
490X80X320 mm

**FREIDORA:** SERIE 900, SERIE 1000  
SERIE 1300

HEATING ELEMENT  
4700W - 380V  
490X80X320 mm

**FRYER:** SERIES 900, SERIES 1000  
SERIES 1300

Código fabricante / Manufacturer Code **240035**



Referencia Code **3128** STANDARD

RESISTENCIA  
5000W - 230V  
415X315X230 mm  
CON CABLES Y VAINA

**FREIDORA:** J-15, N-27

HEATING ELEMENT  
5000W - 230V  
415X315X230 mm  
WITH WIRES & COVER

**FRYER:** J-15, N-27

Código fabricante / Manufacturer Code **2001021**



Referencia Code **13474** ORIGINAL

RESISTENCIA  
8000W - 230/380V  
405X320X220 mm  
CON CABLES Y VAINA

**FREIDORA:** J-15, J-15GP

HEATING ELEMENT  
8000W - 230/380V  
405X320X220 mm  
WITH WIRES & COVER

**FRYER:** J-15, J-15GP

Código fabricante / Manufacturer Code **2001023**



# RESISTENCIAS FREIDORA / FRYER HEATING ELEMENTS

## JEMI



Referencia Code **25107** ORIGINAL

RESISTENCIA  
9500W - 230/380V  
Ø420X255 mm

**FREIDORA:** J-30

HEATING ELEMENT  
9500W - 230/380V  
Ø420X255 mm

**FRYER:** J-30

Código fabricante / Manufacturer Code **2001031**



Referencia Code **48623** STANDARD

RESISTENCIA  
9500W - 230/380V  
Ø420X255 mm

**FREIDORA:** J-30

HEATING ELEMENT  
9500W - 230/380V  
Ø420X255 mm

**FRYER:** J-30

## LAINOX



Referencia Code **84615** ORIGINAL

RESISTENCIA  
6800W - 230V  
299X107 mm

**FREIDORA:** FE92210

HEATING ELEMENT  
6800W - 230V  
299X107 mm

**FRYER:** FE92210

Código fabricante / Manufacturer Code **SIRO108058**

## LOTUS



Referencia Code **19748** ORIGINAL

RESISTENCIA  
1800W - 230V  
310X60X200 mm / M1 2X1

**FREIDORA:** FP-6ET, FQ-4ET, FQ-6ET  
FP-62ET, FQ-61ET, FE-/8, FE-2-8

HEATING ELEMENT  
1800W - 230V  
310X60X200 mm / M1 2X1

**FRYER:** FP-6ET, FQ-4ET, FQ-6ET, FP-62ET,  
FQ-61ET, FE-/8, FE-2-8

\*CÓDIGO JUNTA / GASKET CODE  
1091

Código fabricante / Manufacturer Code **53.7.0035.00**

## LOTUS



Referencia Code **19751** ORIGINAL

RESISTENCIA  
1800W - 230V  
388X127X172 mm / M1 2X1

**FREIDORA:** FPE-20, FMPE-20, FMPE-30

HEATING ELEMENT  
1800W - 380V  
388X127X172 mm / M1 2X1

**FRYER:** FPE-20, FMPE-20, FMPE-30

\*CÓDIGO JUNTA / GASKET CODE  
1091

Código fabricante / Manufacturer Code **53.7.0108.00**



Referencia Code **19749** ORIGINAL

RESISTENCIA  
2000W - 230V  
328X110X196 mm / M1 2X1

**FREIDORA:** FE-10, FME-10, FE-2/10  
FME-2/10

HEATING ELEMENT  
2000W - 230V  
328X110X196 mm / M1 2X1

**FRYER:** FE-10, FME-10, FE-2/10  
FME-2/10

\*CÓDIGO JUNTA / GASKET CODE  
1091

Código fabricante / Manufacturer Code **53.7.0037.00**



Referencia Code **19750** ORIGINAL

RESISTENCIA  
2000W - 230V  
405X89X198 mm / M1 2X1

**FREIDORA:** FME-15, FME-2/15

HEATING ELEMENT  
2000W - 230V  
405X89X198 mm / M1 2X1

**FRYER:** FME-15, FME-2/15

\*CÓDIGO JUNTA / GASKET CODE  
1091

Código fabricante / Manufacturer Code **53.7.0043.00**

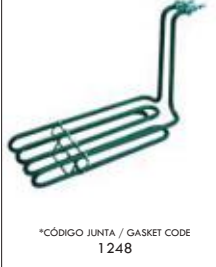

Referencia Code **19746** ORIGINAL

RESISTENCIA  
2500W - 230V  
285X104X205 mm / ROSCA 1/4"

**FREIDORA:** FEC-4

HEATING ELEMENT  
2500W - 230V  
285X104X205 mm / 1/4" THREAD

**FRYER:** FEC-4

\*CÓDIGO JUNTA / GASKET CODE  
1248

Código fabricante / Manufacturer Code **53.7.0031.00**

# RESISTENCIAS FREIDORA / FRYER HEATING ELEMENTS

## LOTUS

 <p>*CÓDIGO JUNTA / GASKET CODE 1091</p>	Referencia Code <b>19752</b> ORIGINAL
	RESISTENCIA 2500W - 230V 390X192X170 mm / M12X1  <b>FREIDORA:</b> FPE-25, FMPE-25 HEATING ELEMENT 2500W - 230V 390X192X170 mm / M12X1  <b>FRYER:</b> FPE-25, FMPE-25
Código fabricante / Manufacturer Code <b>53.7.0109.00</b>	

 <p>*CÓDIGO JUNTA / GASKET CODE 1248</p>	Referencia Code <b>19747</b> ORIGINAL
	RESISTENCIA 3000W - 230V 315X185X180 mm / ROSCA 1/4"  <b>FREIDORA:</b> FQ61EM, FQ62EM, FQ4EM, FQ6EM HEATING ELEMENT 3000W - 230V 315X185X180 mm / 1/4" THREAD  <b>FRYER:</b> FQ61EM, FQ62EM, FQ4EM, FQ6EM
Código fabricante / Manufacturer Code <b>53.7.0033.00</b>	

 <p>*CÓDIGO JUNTA / GASKET CODE 19744</p>	Referencia Code <b>19742</b> ORIGINAL
	RESISTENCIA 9750W - 230V 305X220X35 mm MONTAJE IZQUIERDO  <b>FREIDORA:</b> F13_ (desde N.0210_) HEATING ELEMENT 9750W - 230V 305X220X35 mm LEFT ASSEMBLY  <b>FRYER:</b> F13_ (from N. 0210_)
Código fabricante / Manufacturer Code <b>53.7.0213.01</b>	

 <p>*CÓDIGO JUNTA / GASKET CODE 19744</p>	Referencia Code <b>19743</b> ORIGINAL
	RESISTENCIA 13500W - 230V 340X300X35 mm MONTAJE IZQUIERDO  <b>FREIDORA:</b> F1894G/98G HEATING ELEMENT 13500W - 230V 340X300X35 mm LEFT ASSEMBLY  <b>FRYER:</b> F1894G/98G
Código fabricante / Manufacturer Code <b>53.7.0214.01</b>	

## LOTUS

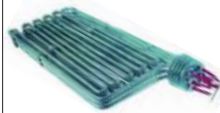
 <p>*CÓDIGO JUNTA / GASKET CODE 19744</p>	Referencia Code <b>19745</b> ORIGINAL
	RESISTENCIA 19500W - 230V 458X190X35 mm MONTAJE DERECHO  <b>FREIDORA:</b> F2594G/98G HEATING ELEMENT 19500W - 230V 458X190X35 mm RIGHT ASSEMBLY  <b>FRYER:</b> F2594G/98G
Código fabricante / Manufacturer Code <b>53.7.0268.00</b>	

 <p>*CÓDIGO JUNTA / GASKET CODE 22313/22319</p>	Referencia Code <b>19429</b> ORIGINAL
	RESISTENCIA 6800W - 230V 300X110X34 mm / M54X1.5  <b>FREIDORA</b> HEATING ELEMENT 6800W - 400V 300X110X34 mm / M54X1.5  <b>FRYER</b>
Código fabricante / Manufacturer Code <b>96002136</b>	

 <p>*CÓDIGO JUNTA / GASKET CODE 22313/22319</p>	Referencia Code <b>19431</b> ORIGINAL
	RESISTENCIA 15000W - 400V 305X290X34 mm / M54X1.5  <b>FREIDORA</b> HEATING ELEMENT 15000W - 400V 305X290X34 mm / M54X1.5  <b>FRYER</b>
Código fabricante / Manufacturer Code <b>96002138</b>	

 <p>*CÓDIGO JUNTA / GASKET CODE 1248</p>	Referencia Code <b>19922</b> ORIGINAL
	RESISTENCIA 1850W - 230V 355X38X287 mm / ROSCA 1/4"  <b>FREIDORA:</b> FR-2E15, FR-4E15, FR-15E/E2 HEATING ELEMENT 1850W - 230V 355X38X287 mm / 1/4" THREAD  <b>FRYER:</b> FR-2E15, FR-4E15, FR-15E/E2
Código fabricante / Manufacturer Code <b>132522</b>	

# RESISTENCIAS FREIDORA / FRYER HEATING ELEMENTS

## MARENO

	Referencia Code	<b>19914</b> ORIGINAL
	RESISTENCIA	2000W - 230V 318X58X200 mm / M12X1
	FREIDORA:	FQE41L (hasta 4.'98), FQE61L (hasta 4.'98), FR7-4E10L (hasta 4.'98), FR7-7E10L (hasta 4.'98), FR9-2E10L, FR9-4E10L
	HEATING ELEMENT	2000W - 230V 318X58X200 mm / M12X1
*CÓDIGO JUNTA / GASKET CODE 1248		
FRYER: FQE41L (until 4.'98), FQE61L (until 4.'98), FR7-4E10L (until 4.'98), FR7-7E10L (until 4.'98), FR9-2E10L, FR9-4E10L		

Código fabricante / Manufacturer Code **10.37314944**

	Referencia Code	<b>19918</b> ORIGINAL
	RESISTENCIA	2300W - 230V 210X66X315 mm / M14X1.5
	FREIDORA:	FR7-4E/7E (1-SERIE)
	HEATING ELEMENT	2300W - 230V 210X66X315 mm / M14X1.5
FRYER: FR7-4E/7E (1-SERIES)		

Código fabricante / Manufacturer Code **1750000**

	Referencia Code	<b>19919</b> ORIGINAL
	RESISTENCIA	2400W - 230V 212X74X310 mm / M14X1.25
	FREIDORA:	FR7-4E/7E (2-SERIE)
	HEATING ELEMENT	2400W - 230V 212X74X310 mm / M14X1.25
FRYER: FR7-4E/7E (2-SERIES)		

Código fabricante / Manufacturer Code **1982700**

	Referencia Code	<b>19939</b> ORIGINAL
	RESISTENCIA	2500W - 230V 285X98X214 mm / M12X1
	FREIDORA:	FQE4
	HEATING ELEMENT	2500W - 230V 285X98X214 mm / M12X1
*CÓDIGO JUNTA / GASKET CODE 1091		
FRYER: FQE4		

Código fabricante / Manufacturer Code **10.37305600**

## MARENO

	Referencia Code	<b>19915</b> ORIGINAL
	RESISTENCIA	3000W - 230V 325X54X206 mm / M12X1
	FREIDORA:	FQE41 (hasta 4.'98), FQE61 (hasta 4.'98), FR7-4E10 (hasta 4.'98), FR7-7E10 (hasta 4.'98), FR9-2E10
	HEATING ELEMENT	3000W - 230V 325X54X206 mm / M12X1
*CÓDIGO JUNTA / GASKET CODE 1091		
FRYER: FQE41 (until 4.'98), FQE61 (until 4.'98), FR7-4E10 (until 4.'98), FR7-7E10 (until 4.'98), FR9-2E10		

Código fabricante / Manufacturer Code **10.37313044**

	Referencia Code	<b>19920</b> ORIGINAL
	RESISTENCIA	3000W - 230V 355X65X325 mm / M14X1.25
	FREIDORA:	FR9-2E13/E13T (2-SERIE), FR9-4E13/13T (2-SERIE)
	HEATING ELEMENT	3000W - 230V 355X65X325 mm / M14X1.25
FRYER: FR9-2E13/E13T (2-SERIES), FR9-4E13/13T (2-SERIES)		

Código fabricante / Manufacturer Code **1982800**

	Referencia Code	<b>19923</b> ORIGINAL
	RESISTENCIA	3000W - 230V 350X55X330 mm / M14X1.5
	FREIDORA:	FR9-2E13 (1-SERIE) FR9-4E13 (1-SERIE)
	HEATING ELEMENT	3000W - 230V 350X55X330 mm / M14X1.5
*CÓDIGO JUNTA / GASKET CODE 1248		
FRYER: FR9-2E13 (1-SERIES) FR9-4E13 (1-SERIES)		

Código fabricante / Manufacturer Code **1463900, 1466100**

	Referencia Code	<b>19940</b> ORIGINAL
	RESISTENCIA	3500W - 230V 288X146X210 mm / ROSCA 1/4"
	FREIDORA:	FQE6, FQE6+6
	HEATING ELEMENT	3500W - 230V 288X146X210 mm / 1/4" THREAD
*CÓDIGO JUNTA / GASKET CODE 1248		
FRYER: FQE6, FQE6+6		

Código fabricante / Manufacturer Code **10.37305700**

# RESISTENCIAS FREIDORA / FRYER HEATING ELEMENTS

## MARENO



Referencia Code **19924** ORIGINAL

RESISTENCIA  
5000W - 230V  
346X58X330 mm / M14X1.25

**FREIDORA:** FR9-2E22 (1 SERIE)  
FR9-4E22 (1 SERIE)

HEATING ELEMENT  
5000W - 230V  
346X58X330 mm / M14X1.25

**FRYER:** FR9-2E22 (1 SERIES)  
FR9-4E22 (1 SERIES)

Código fabricante / Manufacturer Code **1464000, 1466200**

Referencia Code **19912** ORIGINAL



RESISTENCIA  
5500W - 230V  
320X200X210 mm

**FREIDORA:** FQE-40, FQE-60, FRE-702,  
FRE-703

HEATING ELEMENT  
5500W - 230V  
320X200X210 mm

**FRYER:** FQE-40, FQE-60, FRE-702, FRE-703

Código fabricante / Manufacturer Code **10.37039900, 10.37039915, 892900**

Referencia Code **19921** ORIGINAL



RESISTENCIA  
5800W - 230V  
343X110X328 mm / M12X1

**FREIDORA:** FR9-2E22/22T (2 SERIE)  
FR9-4E22/22T (2 SERIE)

HEATING ELEMENT  
5800W - 230V  
343X110X328 mm / M12X1

**FRYER:** FR9-2E22/22T (2 SERIES)  
FR9-4E22/22T (2 SERIES)

Código fabricante / Manufacturer Code **1982900**

Referencia Code **19916** ORIGINAL



RESISTENCIA  
6000W - 230V  
320X175X205 mm

**FREIDORA:** FQE41L, FQE61L

HEATING ELEMENT  
6000W - 230V  
320X175X205 mm

**FRYER:** FQE41L, FQE61L

Código fabricante / Manufacturer Code **10.37317100**

## MARENO



Referencia Code **19913** ORIGINAL

RESISTENCIA  
7250W - 230V  
330X194X212 mm

**FREIDORA:** FR9-2E10, FR9-4E10

HEATING ELEMENT  
7250W - 230V  
330X194X212 mm

**FRYER:** FR9-2E10, FR9-4E10

Código fabricante / Manufacturer Code **10.37301600**

Referencia Code **19917** ORIGINAL



RESISTENCIA  
9000W - 230V  
320X175X205 mm

**FREIDORA:** FQE41 (desde 5.'98)  
FQE61 (desde 5.'98),  
FR74E10 (desde 5.'98), FR9-2E10

HEATING ELEMENT  
9000W - 230V  
320X175X205 mm

**FRYER:** FQE41 (from 5.'98)  
FQE61 (from 5.'98),  
FR74E10 (from 5.'98), FR9-2E10

Código fabricante / Manufacturer Code **10.37317200**

Referencia Code **19925** ORIGINAL



RESISTENCIA  
9000W - 230V  
360X170X35 mm / M54X1.5

**FREIDORA:** F7-\_\_E10, F9-\_\_E10

HEATING ELEMENT  
9000W - 230V  
360X170X35 mm / M54X1.5

**FRYER:** F7-\_\_E10, F9-\_\_E10

Código fabricante / Manufacturer Code **10.37316600, 10.37316601**

Referencia Code **19926** ORIGINAL



RESISTENCIA  
10500W - 230/380V  
320X240X32 mm / M54X1.5

**FREIDORA:** F7-\_\_E12, F9-\_\_E12  
F9S-\_\_E12

HEATING ELEMENT  
10500W - 230/380V  
320X240X32 mm / M54X1.5

**FRYER:** F7-\_\_E12, F9-\_\_E12, F9S-\_\_E12

Código fabricante / Manufacturer Code **CM032101**

# RESISTENCIAS FREIDORA / FRYER HEATING ELEMENTS

## MARENO



\*CÓDIGO JUNTA / GASKET CODE  
19928

Referencia  
Code **19927** ORIGINAL

RESISTENCIA  
16500W - 230V  
400X315X36 mm / M54X1.5

FREIDORA: F9-\_\_E18/18K  
F9S-\_\_E18/18K

HEATING ELEMENT  
16500W - 230V  
400X315X36 mm / M54X1.5

FRYER: F9-\_\_E18/18K, F9S-\_\_E18/18K

Código fabricante / Manufacturer Code **CM032401**

## MBM



\*CÓDIGO JUNTA / GASKET CODE  
19434/22313

Referencia  
Code **22318** ORIGINAL

RESISTENCIA  
18000W - 230V  
300X290X37 mm / M54X1.5

FREIDORA: EF45, EF90

HEATING ELEMENT  
18000W - 230V  
300X290X37 mm / M54X1.5

FRYER: EF45, EF90

Código fabricante / Manufacturer Code **RTBF800318**

## MBM



\*CÓDIGO JUNTA / GASKET CODE  
22313

Referencia  
Code **22316** ORIGINAL

RESISTENCIA  
5250W - 230V  
288X115X34 mm

FREIDORA: EFE472VT

HEATING ELEMENT  
5250W - 230V  
288X115X34 mm

FRYER: EFE472VT

Código fabricante / Manufacturer Code **RTCU700592**

## MODULAR



\*CÓDIGO JUNTA / GASKET CODE  
1248

Referencia  
Code **20035** ORIGINAL

RESISTENCIA  
2500W - 230V  
293X40X205 mm / M14X1.5

FREIDORA: 60/\_FRE, 65/\_FRE, 70/\_FRE,  
90/\_FRE

HEATING ELEMENT  
2500W - 230V  
293X40X205 mm / M14X1.5

FRYER: 60/\_FRE, 65/\_FRE, 70/\_FRE,  
90/\_FRE

Código fabricante / Manufacturer Code **66500100**



\*CÓDIGO JUNTA / GASKET CODE  
22313

Referencia  
Code **22312** ORIGINAL

RESISTENCIA  
9000W - 230V  
285X205X35 mm

FREIDORA: EF46, EF66

HEATING ELEMENT  
9000W - 230V  
285X205X35 mm

FRYER: EF46, EF66

Código fabricante / Manufacturer Code **RTCU600122**

## MOVILFRIT



Código fabricante / Manufacturer Code

Referencia  
Code **4714** ORIGINAL

RESISTENCIA  
2000W - 230V  
170X270X155 mm

FREIDORA: F-6, F-6+6

HEATING ELEMENT  
2000W - 230V  
170X270X155 mm

FRYER: F-6, F-6+6

**901683**



\*CÓDIGO JUNTA / GASKET CODE  
22313

Referencia  
Code **22315** ORIGINAL

RESISTENCIA  
9000W - 230V  
285X205X35 mm

FREIDORA: EF47/77, EF4T/877T

HEATING ELEMENT  
9000W - 230V  
285X205X35 mm

FRYER: EF47/77, EF4T/77T

Código fabricante / Manufacturer Code **RTCU700570**



Código fabricante / Manufacturer Code

Referencia  
Code **13536** ORIGINAL

RESISTENCIA  
2000W - 230V  
DERECHA / CON CABEZAL

FREIDORA: F-6, F-6+6

HEATING ELEMENT  
2000W - 230V  
RIGHT / WITH CONTROL PANEL

FRYER: F-6, F-6+6

**907003**

# RESISTENCIAS FREIDORA / FRYER HEATING ELEMENTS

## MOVILFRIT

	Referencia Code	<b>23617</b> ORIGINAL
		RESISTENCIA 2000W - 230V 170X270X155 mm
	FREIDORA:	6 LITROS ● ● ●
		HEATING ELEMENT 2000W - 230V 170X270X155 mm
FRYER:		6 LITERS
Código fabricante / Manufacturer Code		907005

	Referencia Code	<b>4710</b> STANDARD
		RESISTENCIA 3000W - 230V 165X260X190 mm
	FREIDORA:	FA-9, FA-10, FA-20 ● ● ●
		HEATING ELEMENT 3000W - 230V 165X260X190 mm
FRYER:		FA-9, FA-10, FA-20

	Referencia Code	<b>8626</b> ORIGINAL
		RESISTENCIA 3000W - 230V CON CABEZAL
	FREIDORA:	F-6 ● ● ●
		HEATING ELEMENT 3000W - 230V WITH CONTROL PANEL
FRYER:		F-6
Código fabricante / Manufacturer Code		907022

	Referencia Code	<b>9469</b> ORIGINAL
		RESISTENCIA 3000W - 230V 250X165X200 mm CON CABEZAL
	FREIDORA:	F-10, F-10+10 ● ● ●
		HEATING ELEMENT 3000W - 230V 250X165X200 mm WITH CONTROL PANEL
FRYER:		F-10, F-10+10
Código fabricante / Manufacturer Code		907024

## MOVILFRIT

	Referencia Code	<b>11318</b> ORIGINAL
		RESISTENCIA 3000W - 230V 250X170X200 mm CON CABEZAL
	FREIDORA:	FA-9, FA-20, FA-9+9 ● ● ●
		HEATING ELEMENT 3000W - 230V 250X170X200 mm WITH CONTROL PANEL
FRYER:		FA-9, FA-20, FA-9+9
Código fabricante / Manufacturer Code		907023

	Referencia Code	<b>20812</b> ORIGINAL
		RESISTENCIA 3000W - 230V 265X170X200 mm
	FREIDORA:	FA-9, FA-10, FA-20 ● ● ●
		HEATING ELEMENT 3000W - 230V 265X170X200 mm
FRYER:		FA-9, FA-10, FA-20
Código fabricante / Manufacturer Code		901682

	Referencia Code	<b>4711</b> STANDARD
		RESISTENCIA 4500W - 230V 165X260X190 mm
	FREIDORA:	FH-10, FH-10+10, FAH-10, FAH-10+10 ● ● ●
		HEATING ELEMENT 4500W - 230V 165X260X190 mm
FRYER:		FH-10, FH-10+10, FAH-10, FAH-10+10

	Referencia Code	<b>85772</b> ORIGINAL
		RESISTENCIA 5000W - 230V 170X260X185 mm
	FREIDORA:	FH-10 ● ● ●
		HEATING ELEMENT 5000W - 230V 170X260X185 mm
FRYER:		FH-10
Código fabricante / Manufacturer Code		901675

# RESISTENCIAS FREIDORA / FRYER HEATING ELEMENTS

## MOVILFRIT



Referencia Code **22334** ORIGINAL

RESISTENCIA  
5000W - 230V  
170X260X185 mm  
CON CABEZAL

**FREIDORA:** FH-10, FH-10+10

HEATING ELEMENT  
5000W - 230V  
170X260X185 mm  
WITH CONTROL PANEL

**FRYER:** FH-10, FH-10+10

Código fabricante / Manufacturer Code **907876**

Referencia Code **85772** ORIGINAL



RESISTENCIA  
5000W - 230V  
170X260X185 mm

**FREIDORA:** FH-10

HEATING ELEMENT  
5000W - 230V  
170X260X185 mm

**FRYER:** FH-10

Código fabricante / Manufacturer Code **901675**

Referencia Code **87964** ORIGINAL



RESISTENCIA  
5000W - 230V  
170X260X185 mm

**FREIDORA:** FAH-10

HEATING ELEMENT  
5000W - 230V  
170X260X185 mm

**FRYER:** FAH-10

Código fabricante / Manufacturer Code **901684**

Referencia Code **14394** STANDARD



RESISTENCIA  
5500W - 230V  
170X260X200 mm

**FREIDORA:** F-17, F-17+17, FH-17  
FH-17+17

HEATING ELEMENT  
5500W - 230V  
170X260X200 mm

**FRYER:** F-17, F-17+17, FH-17  
FH-17+17

## MOVILFRIT



Referencia Code **7851** ORIGINAL

RESISTENCIA  
6000W - 380V  
200X370X200 mm

**FREIDORA:** F-17, FH-17, FH-17+17  
FAH-17+17

HEATING ELEMENT  
6000W - 230V  
200X370X200 mm

**FRYER:** F-17, FH-17, FH-17+17  
FAH-17+17

\*CÓDIGO JUNTA / GASKET CODE  
3202

Código fabricante / Manufacturer Code **901678**

Referencia Code **10595** ORIGINAL



RESISTENCIA  
6000W - 380V  
CON CABEZAL

**FREIDORA:** FAH-17, FAH-17+17, FA-17  
FA-17+17

HEATING ELEMENT  
6000W - 230V  
WITH CONTROL PANEL

**FRYER:** FAH-17, FAH-17+17, FA-17  
FA-17+17

Código fabricante / Manufacturer Code **907878**

Referencia Code **10612** ORIGINAL



RESISTENCIA  
6000W - 380V  
370X200X190 mm

**FREIDORA:** F-17, FAH-17+17, FH-17  
FH-17+17

HEATING ELEMENT  
6000W - 230V  
370X200X190 mm

**FRYER:** F-17, FAH-17+17, FH-17  
FH-17+17

Código fabricante / Manufacturer Code **901677**

Referencia Code **22333** ORIGINAL



RESISTENCIA  
6000W - 380V  
370X200X190 mm  
CON CABEZAL

**FREIDORA:** F-17, FA-17, FAH-17

HEATING ELEMENT  
6000W - 230V  
370X200X190 mm  
WITH CONTROL PANEL

**FRYER:** F-17, FA-17, FAH-17

Código fabricante / Manufacturer Code **907879**

# RESISTENCIAS FREIDORA / FRYER HEATING ELEMENTS

## MOVILFRIT

Referencia Code **10122** ORIGINAL



RESISTENCIA  
11000W - 230V  
450X240X230 mm

FREIDORA: FH25, FAH25

HEATING ELEMENT  
11000W - 230V  
450X240X230 mm

FRYER: FH25, FAH25

Código fabricante / Manufacturer Code **901679**

Referencia Code **22335** ORIGINAL



RESISTENCIA  
11000W - 380V  
450X240X230 mm  
CON CABEZAL

FREIDORA: FH25

HEATING ELEMENT  
11000W - 380V  
450X240X230 mm  
WITH CONTROL PANEL

FRYER: FH25

Código fabricante / Manufacturer Code **907880**

Referencia Code **10613** ORIGINAL

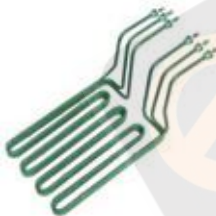

RESISTENCIA  
15000W - 230/380V  
460X240X220 mm

FREIDORA: FH25, FAH25, FAH35

HEATING ELEMENT  
15000W - 230/380V  
460X240X230 mm

FRYER: FH25, FAH25, FAH35

Código fabricante / Manufacturer Code **901680**

Referencia Code **22322** ORIGINAL



RESISTENCIA  
15000W - 230/380V  
460X330X210 mm

FREIDORA: FH35, FAH35

HEATING ELEMENT  
15000W - 230/380V  
460X330X210 mm

FRYER: FH35, FAH35

Código fabricante / Manufacturer Code **901681**

## MOVILFRIT

Referencia Code **22336** ORIGINAL



RESISTENCIA  
15000W - 380V  
460X240X220 mm

FREIDORA: FH-25

HEATING ELEMENT  
15000W - 380V  
460X240X220 mm

FRYER: FH-25

Código fabricante / Manufacturer Code **907881**

Referencia Code **22337** ORIGINAL



RESISTENCIA  
15000W - 380V  
460X240X220 mm

FREIDORA: FH-35

HEATING ELEMENT  
15000W - 380V  
460X240X220 mm

FRYER: FH-35

Código fabricante / Manufacturer Code **907882**

## OLIS

Referencia Code **20213** ORIGINAL



RESISTENCIA  
1700W - 230V  
280X30X365 mm / ROSCA 1/4"

FREIDORA: 710FRE, 712FRE

HEATING ELEMENT  
1700W - 230V  
280X30X365 mm / 1/4" THREAD

FRYER: 710FRE, 712FRE

\*CÓDIGO JUNTA / GASKET CODE  
1248

Código fabricante / Manufacturer Code **9000502**

Referencia Code **20212** ORIGINAL



RESISTENCIA  
2300W - 230V  
340X42X210 mm / M14X1.5

FREIDORA: 41SEFR, 61SEFR

HEATING ELEMENT  
2300W - 230V  
340X42X210 mm / M14X1.5

FRYER: 41SEFR, 61SEFR

Código fabricante / Manufacturer Code **8208200**





# RESISTENCIAS FREIDORA / FRYER HEATING ELEMENTS

## OLIS

	Referencia Code	<b>20214</b> ORIGINAL
	RESISTENCIA 3300W - 230V 295X75X340 mm / ROSCA 1/4"	
	FREIDORA: 720FRE, 722FRE ● ● ●	
	HEATING ELEMENT 3300W - 230V 295X75X340 mm / 1/4" THREAD	
FRYER: 720FRE, 722FRE		
*CÓDIGO JUNTA / GASKET CODE 1248		
Código fabricante / Manufacturer Code <b>9000498</b>		

	Referencia Code	<b>20216</b> ORIGINAL
	RESISTENCIA 3300W - 230V 331X41X260 mm / ROSCA 1/4"	
	FREIDORA: 922FRE ● ● ●	
	HEATING ELEMENT 3300W - 230V 331X41X260 mm / 1/4" THREAD	
FRYER: 922FRE		
*CÓDIGO JUNTA / GASKET CODE 1248		
Código fabricante / Manufacturer Code <b>9000509</b>		

	Referencia Code	<b>20211</b> ORIGINAL
	RESISTENCIA 5500W - 230V 297X168X31 mm / M12X1.5	
	FREIDORA: 40SEFR, 60SEFR ● ● ●	
	HEATING ELEMENT 5500W - 230V 297X168X31 mm / M12X1.5	
FRYER: 40SEFR, 60SEFR		
*CÓDIGO JUNTA / GASKET CODE 1248		
Código fabricante / Manufacturer Code <b>8217600</b>		

	Referencia Code	<b>20215</b> ORIGINAL
	RESISTENCIA 5500W - 230V 320X78X282 mm / ROSCA 1/4"	
	FREIDORA: 921FRE, 941FRE ● ● ●	
	HEATING ELEMENT 5500W - 230V 320X78X282 mm / 1/4" THREAD	
FRYER: 921FRE, 941FRE		
*CÓDIGO JUNTA / GASKET CODE 1248		
Código fabricante / Manufacturer Code <b>9000510</b>		

## OLIS

	Referencia Code	<b>24877</b> ORIGINAL
	RESISTENCIA 5500W - 230V 372X88 mm	
	FREIDORA: ● ● ●	
	HEATING ELEMENT 5500W - 380V 372X88 mm	
FRYER:		
Código fabricante / Manufacturer Code <b>9000495</b>		

## PANAROLA

	Referencia Code	<b>24320</b> ORIGINAL
	RESISTENCIA 3000W - 230V 250X185X180 mm	
	FREIDORA ● ● ●	
	HEATING ELEMENT 3000W - 230V 250X185X180 mm	
FRYER		
Código fabricante / Manufacturer Code <b>---</b>		

	Referencia Code	<b>26990</b> ORIGINAL
	RESISTENCIA 3500W - 230V 260X185 mm	
	FREIDORA: 8 LITROS ● ● ●	
	HEATING ELEMENT 3500W - 230V 260X185 mm	
FRYER: 8 LITERS		
*CÓDIGO JUNTA / GASKET CODE 1248		
Código fabricante / Manufacturer Code <b>---</b>		

	Referencia Code	<b>13492</b> ORIGINAL
	RESISTENCIA 3500W - 230V 250X185X180 mm CON CABEZAL	
	FREIDORA: FR-8/LG ● ● ●	
	HEATING ELEMENT 3500W - 230V 250X185X180 mm WITH CONTROL PANEL	
FRYER: FR-8/LG		
Código fabricante / Manufacturer Code <b>203016</b>		

# RESISTENCIAS FREIDORA / FRYER HEATING ELEMENTS

## PANAROLA



Referencia Code **26991** ORIGINAL

RESISTENCIA  
4500W - 230V  
280X220 mm  
CON CABEZAL

**FREIDORA:** 10 LITROS  
HEATING ELEMENT  
4500W - 230V  
280X220 mm  
WITH CONTROL PANEL

**FRYER:** 10 LITERS

Código fabricante / Manufacturer Code **205006**

Referencia Code **26989** ORIGINAL

RESISTENCIA  
4500W - 230V

**FREIDORA:** 10 LITROS  
HEATING ELEMENT  
4500W - 230V

**FRYER:** 10 LITERS

Código fabricante / Manufacturer Code **205002**



## REPAGAS



\*CÓDIGO JUNTA / GASKET CODE  
1248

Referencia Code **19498** ORIGINAL

RESISTENCIA  
3000W - 230V  
297X86X243 mm / ROSCA 1/4"

**FREIDORA:**  
HEATING ELEMENT  
3000W - 230V  
297X86X243 mm / 1/4" THREAD

**FRYER**

Código fabricante / Manufacturer Code **1130002**

Referencia Code **19499** ORIGINAL

RESISTENCIA  
3333W - 230V  
395X85X245 mm / ROSCA 1/4"

**FREIDORA:**  
HEATING ELEMENT  
3333W - 230V  
395X85X245 mm / 1/4" THREAD

**FRYER**

Código fabricante / Manufacturer Code **9000007**



\*CÓDIGO JUNTA / GASKET CODE  
960

## REPAGAS



Referencia Code **19495** ORIGINAL

RESISTENCIA  
1260W - 230V  
320X48X220 mm / ROSCA 1/4"

**FREIDORA:**  
HEATING ELEMENT  
1260W - 230V  
320X48X220 mm / 1/4" THREAD

**FRYER:**

Código fabricante / Manufacturer Code **8700024**

Referencia Code **19497** ORIGINAL

RESISTENCIA  
2000W - 230V  
315X74X250 mm / ROSCA 1/4"

**FREIDORA:**  
HEATING ELEMENT  
2000W - 230V  
315X74X250 mm / 1/4" THREAD

**FRYER:**

Código fabricante / Manufacturer Code **8800027**



\*CÓDIGO JUNTA / GASKET CODE  
1248



Referencia Code **85772** ORIGINAL

RESISTENCIA  
5000W - 230V  
170X260X185 mm

**FREIDORA:** FE8, FE10M  
HEATING ELEMENT  
5000W - 230V  
170X260X185 mm

**FRYER:** FE8, FE10M

Código fabricante / Manufacturer Code **57203018**

Referencia Code **19500** ORIGINAL

RESISTENCIA  
5500W - 230V  
250X60X250 mm / M14X1.5

**FREIDORA:**  
HEATING ELEMENT  
5500W - 230V  
250X60X250 mm / M14X1.5

**FRYER**

Código fabricante / Manufacturer Code **1140011**

# RESISTENCIAS FREIDORA / FRYER HEATING ELEMENTS

## REPAGAS



Referencia Code **48598** ORIGINAL

RESISTENCIA  
6000W - 230V  
CON CABEZAL

FREIDORA: FE-12

HEATING ELEMENT  
6000W - 230V  
WITH CONTROL PANEL

FRYER: FE-12

Código fabricante / Manufacturer Code **1130016**

Referencia Code **20330** ORIGINAL



RESISTENCIA  
10000W - 380V  
380X195X200 mm

FREIDORA: FE-17/M

HEATING ELEMENT  
10000W - 380V  
380X195X200 mm

FRYER: FE-17/M

Código fabricante / Manufacturer Code **57103018**

Referencia Code **50158** ORIGINAL



RESISTENCIA  
10000W - 380V  
CON CABEZAL

FREIDORA: FE-20+20

HEATING ELEMENT  
10000W - 380V  
WITH CONTROL PANEL

FRYER: FE-20+20

Código fabricante / Manufacturer Code **1180011**

## ROLLER GRILL



Referencia Code **20306** ORIGINAL

RESISTENCIA  
2000W - 230V  
285X118X142 mm

FREIDORA: RF3S

HEATING ELEMENT  
2000W - 230V  
285X118X142 mm

FRYER: RF3S

Código fabricante / Manufacturer Code **D02018**

## ROLLER GRILL



Referencia Code **20307** ORIGINAL

RESISTENCIA  
2000W - 230V  
282X120X175 mm

FREIDORA: RFS, RFDS, RF5S

HEATING ELEMENT  
2000W - 230V  
282X120X175 mm

FRYER: RFS, RFDS, RF5S

Código fabricante / Manufacturer Code **D02010**

Referencia Code **20308** ORIGINAL

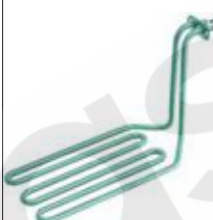

RESISTENCIA  
2500W - 230V  
285X125X177 mm

FREIDORA: RF8DS, RF5SP, RFDSD

HEATING ELEMENT  
2500W - 230V  
285X125X177 mm

FRYER: RF8DS, RF5SP, RFDSD

Código fabricante / Manufacturer Code **D02069**

Referencia Code **20309** ORIGINAL



RESISTENCIA  
3000W - 230V  
300X185X180 mm

FREIDORA: RF8S, RF8DS

HEATING ELEMENT  
3000W - 230V  
300X185X180 mm

FRYER: RF8S, RF8DS

Código fabricante / Manufacturer Code **D02023**

Referencia Code **90224** ORIGINAL



RESISTENCIA  
3600W - 230V  
260X180X170 mm

FREIDORA: FD80R, FD80DR, RD80D, FD80

HEATING ELEMENT  
3600W - 230V  
260X180X170 mm

FRYER: FD80R, FD80DR, RD80D, FD80

Código fabricante / Manufacturer Code **D02070**

# RESISTENCIAS FREIDORA / FRYER HEATING ELEMENTS

## ROLLER GRILL

	Referencia Code	<b>19702</b> ORIGINAL
	RESISTENCIA	3800W - 230V 280X185X170 mm
	FREIDORA:	RF12S, RF12DS • • •
	HEATING ELEMENT	3800W - 230V 280X185X170
	FRYER:	RF12S, RF12DS

Código fabricante / Manufacturer Code **D02025**

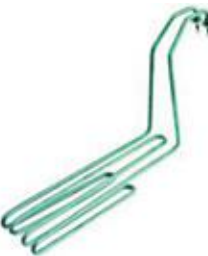
	Referencia Code	<b>20312</b> ORIGINAL
	RESISTENCIA	4000W - 230V 465X82X280 mm
	FREIDORA:	RF14S, RF14DS • • •
	HEATING ELEMENT	4000W - 230V 465X85X280 mm
	FRYER:	RF14S, RF14DS

Código fabricante / Manufacturer Code **D02028**

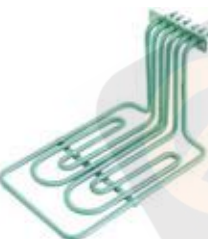
	Referencia Code	<b>20310</b> ORIGINAL
	RESISTENCIA	6000W - 230/400V 292X186X170 mm
	FREIDORA:	RF5SP, RF8DSP, RF12SP • • •
	HEATING ELEMENT	6000W - 230V 292X186X170 mm
	FRYER:	RF5SP, RF8DSP, RF12SP

Código fabricante / Manufacturer Code **D02027**

	Referencia Code	<b>20313</b> ORIGINAL
	RESISTENCIA	6000W - 230V 460X86X290 mm
	FREIDORA:	RF25S, RF25DS • • •
	HEATING ELEMENT	6000W - 230V 460X86X290 mm
	FRYER:	RF25S, RF25DS

Código fabricante / Manufacturer Code **D02099**

## SAMMIC

	Referencia Code	<b>10306</b> STANDARD
	RESISTENCIA	1670W - 230V 300X105X200 mm
	FREIDORA:	FE-12 • • •
	HEATING ELEMENT	1670W - 230V 300X105X200 mm
	FRYER:	FE-12

	Referencia Code	<b>10304</b> ORIGINAL
	RESISTENCIA	2000W - 230V 250X115X180 mm
	FREIDORA:	SF-4 • • •
	HEATING ELEMENT	2000W - 230V 250X115X180 mm
	FRYER:	SF-4

Código fabricante / Manufacturer Code **6421300**

	Referencia Code	<b>10305</b> STANDARD
	RESISTENCIA	3000W - 230V
	FREIDORA:	SF-8 • • •
	HEATING ELEMENT	3000W - 230V
	FRYER:	SF-8

Código fabricante / Manufacturer Code **6421301**

	Referencia Code	<b>10307</b> STANDARD
	RESISTENCIA	3000W - 230V 290X100X250 mm
	FREIDORA:	FE-8 • • •
	HEATING ELEMENT	3000W - 230V 290X100X250 mm
	FRYER:	FE-8

Código fabricante / Manufacturer Code **6130252**

\*CÓDIGO JUNTA / GASKET CODE  
1248

# RESISTENCIAS FREIDORA / FRYER HEATING ELEMENTS

## SILKO



Referencia Code **19570** ORIGINAL

RESISTENCIA  
6000W - 230V  
300X182X252 mm

**FREIDORA:** FR651/652, CFE60110/210, CFE70110/0

HEATING ELEMENT  
6000W - 230V  
300X182X252 mm

**FRYER:** FR651/652, CFE60110/210, CFE70110/0

Código fabricante / Manufacturer Code **0109025**

Referencia Code **19429** ORIGINAL

RESISTENCIA  
6800W - 230/400V  
300X110 mm / M54X1.5

**FREIDORA:** CFE70110/110-2, CFE70210/210-2, EF710G/EF720G, CFE9210/210-2

HEATING ELEMENT  
6800W - 230/400V  
300X110 mm / M54X1.5

**FRYER:** CFE70110/110-2, CFE70210/210-2, EF710G/EF720G, CFE9210/210-2

\*CÓDIGO JUNTA / GASKET CODE  
22313/22319

Código fabricante / Manufacturer Code **0108058**

Referencia Code **19542** ORIGINAL

RESISTENCIA  
10200W - 230/400V  
300X180 mm / M54X1.5

**FREIDORA:** CFE70115/115-2, CFE70215/215-2, EF715G

HEATING ELEMENT  
10200W - 230/400V  
300X180 mm / M54X1.5

**FRYER:** CFE70115/115-2, CFE70215/215-2, EF715G

\*CÓDIGO JUNTA / GASKET CODE  
22313/19928

Código fabricante / Manufacturer Code **0108057**

## TECNOINOX



Referencia Code **20151** ORIGINAL

RESISTENCIA  
2000W - 230V  
255X45X190 mm

**FREIDORA:** FR35E, FR70E

HEATING ELEMENT  
2000W - 230V  
255X45X190 mm

**FRYER:** FR35E, FR70E

\*CÓDIGO JUNTA / GASKET CODE  
1248

Código fabricante / Manufacturer Code **00282**

## TECNOINOX



Referencia Code **20150** ORIGINAL

RESISTENCIA  
3000W - 230V  
250X175X197 mm

**FREIDORA:** FR35E/2, FR7E/2

HEATING ELEMENT  
3000W - 230V  
250X175X197 mm

**FRYER:** FR35E/2, FR7E/2

\*CÓDIGO JUNTA / GASKET CODE  
1248

Código fabricante / Manufacturer Code **00772**

Referencia Code **20152** ORIGINAL

RESISTENCIA  
3600W - 230V  
290X70X245 mm

**FREIDORA:** FR35E7, FR570E7

HEATING ELEMENT  
3600W - 230V  
290X70X245 mm

**FRYER:** FR35E7, FR570E7

\*CÓDIGO JUNTA / GASKET CODE  
1248

Código fabricante / Manufacturer Code **01276**

## VALENTINE



Referencia Code **19442** ORIGINAL

RESISTENCIA  
2300W - 400V  
268X84X190 mm / ROSCA 1/4"

**FREIDORA:** BB-7, BB55

HEATING ELEMENT  
2300W - 400V  
268X84X190 mm / 1/4" THREAD

**FRYER:** BB-7, BB55

Código fabricante / Manufacturer Code **15184**

Referencia Code **19443** ORIGINAL

RESISTENCIA  
2300W - 230V  
268X94X190 mm / ROSCA 1/4"

**FREIDORA:** BB10, BB13

HEATING ELEMENT  
2300W - 230V  
268X94X190 mm / 1/4" THREAD

**FRYER:** BB10, BB13

Código fabricante / Manufacturer Code **15185**

# RESISTENCIAS FREIDORA / FRYER HEATING ELEMENTS

## TECNOINOX



Referencia Code **19439** ORIGINAL

RESISTENCIA  
3000W - 230V  
293X200X135 mm

**FREIDORA:** MAXI30  
••••  
HEATING ELEMENT  
3000W - 230V  
293X200X135 mm

**FRYER:** MAXI30

Código fabricante / Manufacturer Code 19022-61



Referencia Code **19441** ORIGINAL

RESISTENCIA  
3600W - 230V  
370X138X190 mm / ROSCA 1/4"

**FREIDORA:** BB55, BB7  
••••  
HEATING ELEMENT  
3600W - 230V  
370X138X190 mm / 1/4" THREAD

**FRYER:** BB55, BB7

Código fabricante / Manufacturer Code 15181



Referencia Code **19444** ORIGINAL

RESISTENCIA  
3600W - 400V  
268X145X190 mm / ROSCA 1/4"

**FREIDORA:**  
••••  
HEATING ELEMENT  
3600W - 400V  
268X145X190 mm / 1/4" THREAD

**FRYER:**

Código fabricante / Manufacturer Code 15182



Referencia Code **19440** ORIGINAL

RESISTENCIA  
6400W - 230V  
285X278X170 mm

**FREIDORA:** MAXI60  
••••  
HEATING ELEMENT  
6400W - 230V  
285X278X170 mm

**FRYER:** MAXI60

Código fabricante / Manufacturer Code 19024-54

## ZANUSSI



Referencia Code **22338** ORIGINAL

RESISTENCIA  
1500W - 230V  
375X26X275 mm

**FREIDORA:** RFR/E302, RFR/E312, MFR/E370  
••••  
HEATING ELEMENT  
1500W - 230V  
375X26X275 mm

**FRYER:** RFR/E302, RFR/E312, MFR/E370

Código fabricante / Manufacturer Code 58612



Referencia Code **22341** ORIGINAL

RESISTENCIA  
1500W - 230V  
320X25X215 mm

**FREIDORA:** MF/1D05, PFRE370  
••••  
HEATING ELEMENT  
1500W - 230V  
320X25X215 mm

**FRYER:** MF/1D05, PFRE370

Código fabricante / Manufacturer Code 04752



Referencia Code **20151** ORIGINAL

RESISTENCIA  
2000W - 230V  
255X45X190 mm

**FREIDORA:** SFRE350/700  
••••  
HEATING ELEMENT  
2000W - 230V  
255X45X190 mm

**FRYER:** SFRE350/700

\*CÓDIGO JUNTA / GASKET CODE  
1248

Código fabricante / Manufacturer Code 04926



Referencia Code **22349** ORIGINAL

RESISTENCIA  
2700W - 230V  
410X165 mm

**FREIDORA:** MF/E1S08, MF/E2D08, MF/E1S07, MF/E2D07, MFR/E1S08, MFR/E2D07, MFR/E2D08, PFRE381/731  
••••  
HEATING ELEMENT  
2700W - 230V  
410X165 mm

**FRYER:** MF/E1S08, MF/E2D08, MF/E1S07, MF/E2D07, MFR/E1S08, MFR/E2D07, MFR/E2D08, PFRE381/731

Código fabricante / Manufacturer Code 04755

# RESISTENCIAS FREIDORA / FRYER HEATING ELEMENTS

## ZANUSSI

	Referencia Code	<b>22342</b> ORIGINAL
	RESISTENCIA 2900W - 230V 310X60X195 mm	
	<b>FREIDORA:</b> MF/E1S12, MF/E2D12, PFRE350/700 ••• HEATING ELEMENT 2900W - 230V 310X60X195 mm	
	<b>FRYER:</b> MF/E1S12, MF/E2D12, PFRE350/700	
Código fabricante / Manufacturer Code <b>05964</b>		

	Referencia Code	<b>22343</b> ORIGINAL
	RESISTENCIA 2900W - 230V 270X50X246 mm	
	<b>FREIDORA:</b> MFR/E1S12, MFR/E2D12, PRFE360/700 ••• HEATING ELEMENT 2900W - 230V 270X50X246 mm	
	<b>FRYER:</b> MFR/E1S12, MFR/E2D12, PRFE360/700	
Código fabricante / Manufacturer Code <b>A5565</b>		

	Referencia Code	<b>22344</b> ORIGINAL
	RESISTENCIA 2900W - 230V 285X82X245 mm	
	<b>FREIDORA:</b> MFR/E2S40, PRFE740 ••• HEATING ELEMENT 2900W - 230V 285X82X245 mm	
	<b>FRYER:</b> MFR/E2S40, PRFE740	
Código fabricante / Manufacturer Code <b>04767</b>		

	Referencia Code	<b>22339</b> ORIGINAL
	RESISTENCIA 3000W - 230V 400X70X270 mm	
	<b>FREIDORA:</b> RFR/E305, RFR/E701, RFR/E315, RFR/E711, MFR/E350, MFR/E700 ••• HEATING ELEMENT 3000W - 230V 400X70X270 mm	
	<b>FRYER:</b> RFR/E305, RFR/E701, RFR/E315, RFR/E711, MFR/E350, MFR/E700	
Código fabricante / Manufacturer Code <b>58615</b>		

## ZANUSSI

	Referencia Code	<b>22345</b> ORIGINAL
	RESISTENCIA 4000W - 230V 415X95X340 mm	
	<b>FREIDORA:</b> HFR-E420, HFR-E840 ••• HEATING ELEMENT 4000W - 230V 415X95X340 mm	
	<b>FRYER:</b> HFR-E420, HFR-E840	
Código fabricante / Manufacturer Code <b>52327</b>		

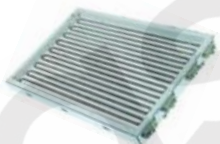
	Referencia Code	<b>22350</b> ORIGINAL
	RESISTENCIA 5000W - 230V 410X280 mm	
	<b>FREIDORA:</b> MFR/E1S14, MFR/E2D14, PFRE355/705, NFRE400/800 ••• HEATING ELEMENT 5000W - 230V 410X280 mm	
	<b>FRYER:</b> MFR/E1S14, MFR/E2D14, PFRE355/705, NFRE400/800	
Código fabricante / Manufacturer Code <b>05942</b>		

	Referencia Code	<b>22347</b> ORIGINAL
	RESISTENCIA 5500W - 230V 320X86X248 mm	
	<b>FREIDORA:</b> HFR/E410/412, HFR/E418/810/818 ••• HEATING ELEMENT 5500W - 230V 320X86X248 mm	
	<b>FRYER:</b> HFR/E410/412, HFR/E418/810/818	
Código fabricante / Manufacturer Code <b>59563</b>		

	Referencia Code	<b>22348</b> ORIGINAL
	RESISTENCIA 5500W - 230V 320X86X248 mm	
	<b>FREIDORA:</b> HFR/E431/931, NFRE410/810 ••• HEATING ELEMENT 5500W - 230V 320X86X248 mm	
	<b>FRYER:</b> HFR/E431/931, NFRE410/810	
Código fabricante / Manufacturer Code <b>06571</b>		

# RESISTENCIAS FREIDORA / FRYER HEATING ELEMENTS

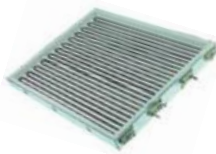
ZANUSSI	
	Referencia Code <b>20483</b> ORIGINAL
	RESISTENCIA 9000W - 400V 435X340 mm
	<b>FREIDORA:</b> HFH/E430, HFH/E435, HFR/E430, HFR/830, NFRE420/820, NFRE430/435/440
	HEATING ELEMENT 9000W - 400V 435X340 mm
<b>FRYER:</b> HFH/E430, HFH/E435, HFR/E430, HFR/830, NFRE420/820, NFRE430/435/440	Código fabricante / Manufacturer Code <b>06158</b>

ZANUSSI	
	Referencia Code <b>22340</b> ORIGINAL
	RESISTENCIA 9500W - 230V 405X246X390 mm
	<b>FREIDORA:</b> MFR/E305, MFR/E306, MFR/E705, MFR/E706, MFR/E740
	HEATING ELEMENT 9500W - 230V 405X246X390 mm
<b>FRYER:</b> MFR/E305, MFR/E306, MFR/E705, MFR/E706, MFR/E740	Código fabricante / Manufacturer Code <b>54923</b>

# RESISTENCIAS HORNO / OVEN HEATING ELEMENTS

AMBACH	
	Referencia Code <b>19222</b> ORIGINAL
	RESISTENCIA 1500W - 400V 540X476 mm / ROSCA 1/4"
	<b>HORNO:</b> EHE70
	HEATING ELEMENT 1500W - 400V 540X476 mm / 1/4" THREAD
<b>OVEN:</b> EHE70	Código fabricante / Manufacturer Code <b>5060804027</b>

AMBACH	
	Referencia Code <b>19227</b> ORIGINAL
	RESISTENCIA 3000W - 400V 670X445 mm
	<b>HORNO:</b> EPE80
	HEATING ELEMENT 3000W - 400V 670X445 mm
<b>OVEN:</b> EPE80	Código fabricante / Manufacturer Code <b>5060804348</b>

AMBACH	
	Referencia Code <b>19224</b> ORIGINAL
	RESISTENCIA 1500W - 400V 560X473 mm
	<b>HORNO:</b> EKE70
	HEATING ELEMENT 1500W - 400V 560X473 mm
<b>OVEN:</b> EKE70	Código fabricante / Manufacturer Code <b>5060808561</b>

AMBACH	
	Referencia Code <b>19229</b> ORIGINAL
	RESISTENCIA 3000W - 400V 607X447 mm
	<b>HORNO:</b> EPSE80
	HEATING ELEMENT 3000W - 400V 607X447 mm
<b>OVEN:</b> EPSE80	Código fabricante / Manufacturer Code <b>5060825601</b>

AMBACH	
	Referencia Code <b>19226</b> ORIGINAL
	RESISTENCIA 2000W - 400V 570X445 mm
	<b>HORNO:</b> EPE80, EPSE80, UBE90
	HEATING ELEMENT 2000W - 400V 570X445 mm
<b>OVEN:</b> EPE80, EPSE80, UBE90	Código fabricante / Manufacturer Code <b>5060804349</b>

AMBACH	
	Referencia Code <b>19230</b> ORIGINAL
	RESISTENCIA 3000W - 400V 453X403 mm
	<b>HORNO:</b> UBE/90
	HEATING ELEMENT 3000W - 400V 453X403 mm
<b>OVEN:</b> UBE/90	Código fabricante / Manufacturer Code <b>5060815275</b>



# RESISTENCIAS HORNO / OVEN HEATING ELEMENTS

## AMBACH

	Referencia Code	<b>19225</b> ORIGINAL
		RESISTENCIA 3000W - 400V 607X447 mm
	HORNO:	EKE70
		HEATING ELEMENT 3000W - 400V 607X447 mm
	OVEN:	EKE70

Código fabricante / Manufacturer Code **5060825601**

	Referencia Code	<b>19223</b> ORIGINAL
		RESISTENCIA 3500W - 400V 535X510 mm / ROSCA 1/4"
	HORNO:	EHE70
		HEATING ELEMENT 3500W - 400V 535X510 mm / 1/4" THREAD
	OVEN:	EHE70

\*CÓDIGO JUNTA / GASKET CODE  
1248

Código fabricante / Manufacturer Code **5060804028**

## ANGELO PO

	Referencia Code	<b>19386</b> ORIGINAL
		RESISTENCIA 800W - 230V 405X122X16 mm
	HORNO:	JUNIOR (51/GE)
		HEATING ELEMENT 800W - 230V 405X122X16 mm
	OVEN:	JUNIOR (51/GE)

Código fabricante / Manufacturer Code **3260160**

	Referencia Code	<b>19385</b> ORIGINAL
		RESISTENCIA 900W - 230V 430X122X28 mm
	HORNO:	JUNIOR (52/E), COMBI (62/GE)
		HEATING ELEMENT 900W - 230V 430X122X28 mm
	OVEN:	JUNIOR (52/E), COMBI (62/GE)

Código fabricante / Manufacturer Code **3260080**

## ANGELO PO

	Referencia Code	<b>22240</b> ORIGINAL
		RESISTENCIA 2500W - 230V 655X120 mm
	HORNO:	FCA10E
		HEATING ELEMENT 2500W - 230V 655X120 mm
	OVEN:	FCA10E

Código fabricante / Manufacturer Code **3261280**

	Referencia Code	<b>19388</b> ORIGINAL
		RESISTENCIA 2600W - 400V 305X510 mm
	HORNO:	JUNIOR (31GE, 31TCE)
		HEATING ELEMENT 2600W - 400V 305X510 mm
	OVEN:	JUNIOR (31GE, 31TCE)

Código fabricante / Manufacturer Code **3261621, 3261630**

	Referencia Code	<b>19389</b> ORIGINAL
		RESISTENCIA 2600W - 400V 460X505 mm
	HORNO:	JUNIOR (31GE, 31TCE)
		HEATING ELEMENT 2600W - 400V 460X505 mm
	OVEN:	JUNIOR (31GE, 31TCE)

Código fabricante / Manufacturer Code **3260151, 3261350**

	Referencia Code	<b>19387</b> ORIGINAL
		RESISTENCIA 2700W - 400V 450X590 mm
	HORNO:	SENIOR (71GE, 71E)
		HEATING ELEMENT 2700W - 400V 450X590 mm
	OVEN:	SENIOR (71GE, 71E)

Código fabricante / Manufacturer Code **3260950, 3260951**

# RESISTENCIAS HORNO / OVEN HEATING ELEMENTS

## ANGELO PO

	Referencia Code	<b>20801</b> ORIGINAL
	RESISTENCIA 2800W - 230V ØINT: 217 mm - ØEXT: 230 mm 249X72 mm	
	HORNO: FCV3 ● ● ● HEATING ELEMENT 2800W - 230V INNØ: 217 mm - EXTØ: 230 mm 249X72 mm	
	OVEN: FCV3	
Código fabricante / Manufacturer Code <b>3260430</b>		

	Referencia Code	<b>22241</b> ORIGINAL
	RESISTENCIA 3500W - 230V 655X120 mm	
	HORNO: FCA201E ● ● ● HEATING ELEMENT 3500W - 230V 655X120 mm	
	OVEN: FCA201E	
Código fabricante / Manufacturer Code <b>3261360</b>		

	Referencia Code	<b>20802</b> ORIGINAL
	RESISTENCIA 4150W - 230V ØINT: 214 mm - ØEXT: 226 mm 248X70 mm	
	HORNO: FCV4 ● ● ● HEATING ELEMENT 4150W - 230V INNØ: 214 mm - EXTØ: 226 mm 248X70 mm	
	OVEN: FCV4	
Código fabricante / Manufacturer Code <b>3261940</b>		

	Referencia Code	<b>22247</b> ORIGINAL
	RESISTENCIA 6000W - 230V 338X37X50 mm	
	HORNO: FV2SE ● ● ● HEATING ELEMENT 6000W - 230V 338X37X50 mm	
	OVEN: FV2SE	
Código fabricante / Manufacturer Code <b>3260400, 3262580, 326520, 3260920</b>		

\*CÓDIGO JUNTA / GASKET CODE  
90808

## ANGELO PO

	Referencia Code	<b>20803</b> ORIGINAL
	RESISTENCIA 8700W - 230V ØINT: 317 mm - ØEXT: 333 mm 375X100 mm	
	HORNO: FC61, FCV61 ● ● ● HEATING ELEMENT 2500W - 230V INNØ: 317 mm - EXTØ: 333 mm 375X100 mm	
	OVEN: FC61, FCV61	
Código fabricante / Manufacturer Code <b>3261691</b>		

	Referencia Code	<b>20804</b> ORIGINAL
	RESISTENCIA 16400W - 230V ØINT: 441 mm - ØEXT: 458 mm 492X143 mm	
	HORNO: FC101, FCV101, FCV141 ● ● ● HEATING ELEMENT 16400W - 230V INNØ: 441 mm - EXTØ: 458 mm 492X143 mm	
	OVEN: FC101, FCV101, FCV141	
Código fabricante / Manufacturer Code <b>3261701</b>		

	Referencia Code	<b>20805</b> ORIGINAL
	RESISTENCIA 24000W - 400V ØINT: 518 mm - ØEXT: 535 mm 590X143 mm	
	HORNO: FC241, FCV241, FCV401 ● ● ● HEATING ELEMENT 24000W - 400V INNØ: 518 mm - EXTØ: 535 mm 590X143 mm	
	OVEN: FC241, FCV241, FCV401	
Código fabricante / Manufacturer Code <b>3261711</b>		

## BALAY

	Referencia Code	<b>87155</b> STANDARD
	RESISTENCIA 1700W - 230V 316X270X54 mm	
	HORNO ● ● ● HEATING ELEMENT 1700W - 230V 316X270X54 mm	
	OVEN	

# RESISTENCIAS HORNO / OVEN HEATING ELEMENTS

## BALAY

	Referencia Code	<b>10603</b> STANDARD
		RESISTENCIA 2000W - 230V Ø187X155X24 mm
	HORNO	• • • HEATING ELEMENT 2000W - 230V Ø187X155X24 mm
	OVEN	

	Referencia Code	<b>87203</b> STANDARD
		RESISTENCIA 3345W+875W - 230V 315X260X54 mm
	HORNO	• • • HEATING ELEMENT 3345W+875 - 230V 315X260X54 mm
	OVEN	

	Referencia Code	<b>87315</b> STANDARD
		RESISTENCIA 900W+1600W - 230V 334X330 mm
	HORNO	• • • HEATING ELEMENT 900W+1600W - 230V 334X330 mm
	OVEN	

## BARON

	Referencia Code	<b>19493</b> ORIGINAL
		RESISTENCIA 1500W - 230V 525X315 mm
	HORNO: SERIE 700, SERIE 900	• • • HEATING ELEMENT 1500W - 230V 525X315 mm
	OVEN: SERIES 700, SERIES 900	

Código fabricante / Manufacturer Code **826620041**

## BARON

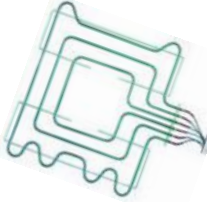
	Referencia Code	<b>20202</b> ORIGINAL
		RESISTENCIA 2750W - 230V 515X580 mm
	HORNO	• • • HEATING ELEMENT 2750W - 230V 515X580 mm
	OVEN	

Código fabricante / Manufacturer Code **6A037400**

## BERTO'S

	Referencia Code	<b>22180</b> ORIGINAL
		RESISTENCIA 990W - 230V 468X112X23 mm
	HORNO: FE	• • • HEATING ELEMENT 990W - 230V 468X112X23 mm
	OVEN: FE	

Código fabricante / Manufacturer Code **31320000**

	Referencia Code	<b>22183</b> ORIGINAL
		RESISTENCIA 920W - 230V ØINT: 200 mm - ØEXT: 215mm 255X40 mm / ROSCA 1/4"
	HORNO: FC06E, FC12E	• • • HEATING ELEMENT 920W - 230V INNØ: 200 mm - EXTØ: 215mm 255X40 mm / 1/4" THREAD
	OVEN: FC06E, FC12E	

Código fabricante / Manufacturer Code **23016600**

	Referencia Code	<b>22179</b> ORIGINAL
		RESISTENCIA 1500W - 230V 365X500 mm
	HORNO: FCGN	• • • HEATING ELEMENT 1500W - 230V 365X500 mm
	OVEN: FCGN	

Código fabricante / Manufacturer Code **22016700**

# RESISTENCIAS HORNO / OVEN HEATING ELEMENTS

## BERTO'S

Referencia  
Code **19605** ORIGINAL



RESISTENCIA INFERIOR  
2500W - 230V  
ØINT: 178 mm - ØEXT: 190 mm  
242X35 mm

HORNO: FCGN

• • •  
LOWER HEATING ELEMENT  
2500W - 230V  
INNØ: 178 mm - EXTØ: 190 mm  
242X35 mm

OVEN: FCGN

Código fabricante / Manufacturer Code **22015500**

Referencia  
Code **22181** ORIGINAL



RESISTENCIA  
2500W - 230V  
ØINT: 187 mm - ØEXT: 200 mm  
215X25 mm

HORNO: FE1/2

• • •  
HEATING ELEMENT  
2500W - 230V  
INNØ: 187 mm - EXTØ: 200 mm  
215X25 mm

OVEN: FE1/2

Código fabricante / Manufacturer Code **23019200**

Referencia  
Code **19604** ORIGINAL

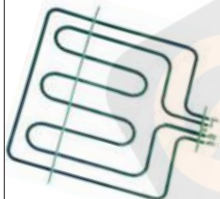

RESISTENCIA GRILL  
2600W - 230V  
350X355 mm

HORNO: FCGN

• • •  
GRILL HEATING ELEMENT  
2600W - 230V  
350X355 mm

OVEN: FCGN

Código fabricante / Manufacturer Code **22016900**

Referencia  
Code **22227** ORIGINAL



RESISTENCIA  
3000W - 230V  
220X65 mm

HORNO: FM200E\_, FM201E\_

• • •  
HEATING ELEMENT  
3000W - 230V  
220X65 mm

OVEN: FM200E\_, FM201E\_

Código fabricante / Manufacturer Code **10622**

## BERTO'S

Referencia  
Code **22182** ORIGINAL



RESISTENCIA  
3300W - 230V  
ØINT: 185 mm - ØEXT: 200 mm  
215X30 mm

HORNO: FC06E, FC12E

• • •  
HEATING ELEMENT  
3300W - 230V  
INTØ: 185 mm - EXTØ: 200 mm  
215X30 mm

OVEN: FC06E, FC12E

Código fabricante / Manufacturer Code **23020500**

Referencia  
Code **22225** ORIGINAL



RESISTENCIA  
3500W - 230V  
620X120X33 mm

HORNO: FC12S\_, \_10E\_

• • •  
HEATING ELEMENT  
3500W - 230V  
620X120X33 mm

OVEN: FC12S\_, \_10E\_

Código fabricante / Manufacturer Code **25040600**

Referencia  
Code **22219** ORIGINAL



RESISTENCIA  
3900W - 230V  
ØINT: 176 mm - ØEXT: 244 mm  
282X73 mm

HORNO: MM2/3

• • •  
HEATING ELEMENT  
3900W - 230V  
INNØ: 176 mm - EXTØ: 244 mm  
282X73 mm

OVEN: MM2/3

Código fabricante / Manufacturer Code **25020800**

Referencia  
Code **22226** ORIGINAL



RESISTENCIA  
4360W - 230V  
310X31X35 mm

HORNO: FM06E, FM10E, FM20E

• • •  
HEATING ELEMENT  
4360W - 230V  
310X31X35 mm

OVEN: FM06E, FM10E, FM20E

Código fabricante / Manufacturer Code **25021600**

# RESISTENCIAS HORNO / OVEN HEATING ELEMENTS

## BERTO'S

	Referencia Code	<b>22220</b> ORIGINAL
	RESISTENCIA 6000W - 230V ØINT: 217 mm - ØEXT: 231 mm 271X90 mm	
	HORNO: FC06E, FC12E HEATING ELEMENT 6000W - 230V INNØ: 217 mm - EXTØ: 231 mm 271X90 mm	
	OVEN: FC06E, FC12E	
Código fabricante / Manufacturer Code <b>23021300</b>		

	Referencia Code	<b>22228</b> ORIGINAL
	RESISTENCIA 6000W - 230V 445X68 mm	
	HORNO: FM401E_ HEATING ELEMENT 6000W - 230V 445X68 mm	
	OVEN: FM401E_	
Código fabricante / Manufacturer Code <b>10620</b>		

	Referencia Code	<b>22221</b> ORIGINAL
	RESISTENCIA 8000W - 230V ØINT: 250 mm - ØEXT: 265 mm 277X75 mm	
	HORNO: FC06S, FM06, MM06 HEATING ELEMENT 8000W - 230V INNØ: 250 mm - EXTØ: 265 mm 277X75 mm	
	OVEN: FC06S, FM06, MM06	
Código fabricante / Manufacturer Code <b>25021400</b>		

	Referencia Code	<b>22223</b> ORIGINAL
	RESISTENCIA 9000W - 230V ØINT: 500 mm - ØEXT: 515 mm 535X95 mm	
	HORNO: _200E_, _401E_ HEATING ELEMENT 9000W - 230V INNØ: 500 mm - EXTØ: 515 mm 535X95 mm	
	OVEN: _200E_, _401E_	
Código fabricante / Manufacturer Code <b>10633</b>		

## BERTO'S

	Referencia Code	<b>22224</b> ORIGINAL
	RESISTENCIA 16000W - 230V ØINT: 337 mm - ØEXT: 358 mm 450X100 mm	
	HORNO: _201E_ HEATING ELEMENT 16000W - 230V INNØ: 337 mm - EXTØ: 358 mm 450X100 mm	
	OVEN: _201E_	
Código fabricante / Manufacturer Code <b>10638</b>		

	Referencia Code	<b>22222</b> ORIGINAL
	RESISTENCIA 16000W - 230V ØINT: 390 mm - ØEXT: 410 mm 430X99 mm	
	HORNO: _200E_, _401E_ HEATING ELEMENT 16000W - 230V INNØ: 390 mm - EXTØ: 410 mm 430X99 mm	
	OVEN: _200E_, _401E_	
Código fabricante / Manufacturer Code <b>10641</b>		

## CORBERÓ

	Referencia Code	<b>87204</b> STANDARD
	RESISTENCIA 1700W - 230V 340X357X18 mm	
	HORNO: HEATING ELEMENT 1700W - 230V 340X357X18 mm	
	OVEN:	

## COVEN

	Referencia Code	<b>88805</b> ORIGINAL
	RESISTENCIA 3000W - 230V Ø190X75 mm	
	HORNO: TEC3, TEC3H, TEC3MX, TEC4P, TEC4MX, TEC6, TEC10, TEC10MX HEATING ELEMENT 3000W - 230V Ø190X75 mm	
	OVEN: TEC3, TEC3H, TEC3MX, TEC4P, TEC4MX, TEC6, TEC10, TEC10MX	
Código fabricante / Manufacturer Code <b>EMRSB030</b>		

# RESISTENCIAS HORNO / OVEN HEATING ELEMENTS

## COVEN

	Referencia Code	<b>89559</b> ORIGINAL
		RESISTENCIA 3300W - 230V ØINT:178 mm ØEXT:190 mm 205X34 mm
	HORNO:	TEC6MD ● ● ●
		HEATING ELEMENT 3300W - 230V INNØ: 178 mm - EXTØ:190 mm 205X34 mm
	OVEN:	TEC6MD
Código fabricante / Manufacturer Code		EMRSB033

## DOBRA

	Referencia Code	<b>25251</b> ORIGINAL
		RESISTENCIA 1000W+2000W - 230V 570X120 mm
	HORNO:	1011 ● ● ●
		HEATING ELEMENT 1000W+2000W - 230V 570X120 mm
	OVEN:	1011
Código fabricante / Manufacturer Code		30000134

## CUPPONE

	Referencia Code	<b>83050</b> ORIGINAL
		RESISTENCIA 800W - 230V 567X128 mm
	HORNO:	● ● ●
		HEATING ELEMENT 800W - 230V 567X128 mm
	OVEN:	
Código fabricante / Manufacturer Code		---

	Referencia Code	<b>25252</b> ORIGINAL
		RESISTENCIA 1200W - 230V 270X115 mm
	HORNO:	P14 ● ● ●
		HEATING ELEMENT 1200W - 230V 270X115 mm
	OVEN:	P14

## 25080 ORIGINAL

	Referencia Code	<b>25080</b> ORIGINAL
		RESISTENCIA 2000W - 230V 892X245 mm / ROSCA 1/4"
	HORNO:	TECHNO, VIP9, VIP29 ● ● ●
		HEATING ELEMENT 2000W - 230V 892X245 mm / 1/4" THREAD
	OVEN:	TECHNO, VIP9, VIP29
Código fabricante / Manufacturer Code		91711033

	Referencia Code	<b>12659</b> STANDARD
		RESISTENCIA 1260W - 230V Ø190 mm
	HORNO:	● ● ●
		HEATING ELEMENT 1260W - 230V Ø190 mm
	OVEN:	

## DIFRI

	Referencia Code	<b>48276</b> ORIGINAL
		RESISTENCIA 2400W - 230V 330X300 mm
	HORNO:	43MX ● ● ●
		HEATING ELEMENT 2400W - 230V 330X300 mm
	OVEN:	43MX
Código fabricante / Manufacturer Code		RES008

	Referencia Code	<b>95342</b> ORIGINAL
		RESISTENCIA 1760W - 230V Ø190 mm
	HORNO:	MODERNO ● ● ●
		HEATING ELEMENT 1760W - 230V Ø190 mm
	OVEN:	NEW
Código fabricante / Manufacturer Code		30000107

# RESISTENCIAS HORNO / OVEN HEATING ELEMENTS

## DOBRA

Referencia Code **17539** STANDARD



RESISTENCIA  
3000W - 230V  
Ø190 mm

HORNO

HEATING ELEMENT  
3000W - 230V  
Ø190 mm

OVEN

Código fabricante / Manufacturer Code

Referencia Code **95343** ORIGINAL



RESISTENCIA  
3100W - 230V  
Ø190 mm

HORNO: MODERNO

HEATING ELEMENT  
3100W - 230V  
Ø190 mm

OVEN: NEW

Código fabricante / Manufacturer Code **30000305**

Referencia Code **47142** ORIGINAL



RESISTENCIA  
3500W - 230V  
Ø200 mm

HORNO: CR3

HEATING ELEMENT  
3500W - 230V  
Ø200 mm

OVEN: CR3

Código fabricante / Manufacturer Code **30000954**

## EKA

Referencia Code **85785** STANDARD



RESISTENCIA  
2500W - 230V  
ØINT: 180 mm - ØEXT: 192 mm  
245X25mm

HORNO: KF412, KF412U, KF723M, KF723, KF921, KF964AL, KF964ALM, KF964I, KF964IM

HEATING ELEMENT  
2500W - 230V  
INNØ: 180 mm - EXTØ: 192 mm  
245X25mm

OVEN: KF412, KF412U, KF723M, KF723, KF921, KF964AL, KF964ALM, KF964I, KF964IM

Código fabricante / Manufacturer Code **99509770**

## EMMEPI

Referencia Code **22183** ORIGINAL



RESISTENCIA  
920W - 230V  
ØINT: 200 mm - ØEXT: 215 mm  
255X40mm / ROSCA 1/4"

HORNO

HEATING ELEMENT  
920W - 230V  
INNØ: 200 mm - EXTØ: 215 mm  
255X40mm / 1/4" THREAD

OVEN

\*CÓDIGO JUNTA / GASKET CODE  
1248

Código fabricante / Manufacturer Code **808779**

Referencia Code **19527** ORIGINAL



RESISTENCIA  
2200W - 230V  
435X500X60mm

HORNO: SERIE 650

HEATING ELEMENT  
2200W - 230V  
435X500X60mm

OVEN: SERIES 650

Código fabricante / Manufacturer Code **C10192**

Referencia Code **19529** ORIGINAL

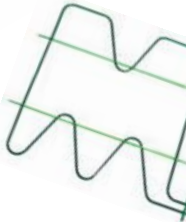

RESISTENCIA  
2500W - 230V  
520X555

HORNO: SERIE 750, SERIE 900

HEATING ELEMENT  
2500W - 230V  
520X555mm

OVEN: SERIES 750, SERIES 900

Código fabricante / Manufacturer Code **C10194**

Referencia Code **22171** ORIGINAL



RESISTENCIA  
2500W - 230V  
530X615 mm

HORNO

HEATING ELEMENT  
2500W - 230V  
530X615mm

OVEN

Código fabricante / Manufacturer Code **814382**

# RESISTENCIAS HORNO / OVEN HEATING ELEMENTS

## EMMEPI

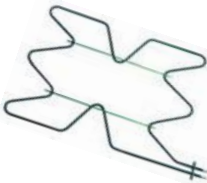
	Referencia Code	<b>19528</b> ORIGINAL
	HORNO	RESISTENCIA 3000W - 230V 715X470 mm
	OVEN	HEATING ELEMENT 3000W - 230V 715X470 mm

Código fabricante / Manufacturer Code **C10193**

	Referencia Code	<b>22232</b> ORIGINAL
	HORNO	RESISTENCIA 3150W - 230V ØINT: 201mm - ØEXT: 215mm 272X35 mm
	OVEN	HEATING ELEMENT 3150W - 230V INNØ: 201mm - EXTØ: 215mm 272X35 mm

Código fabricante / Manufacturer Code **142110001**

	Referencia Code	<b>22182</b> ORIGINAL
	HORNO	RESISTENCIA 3300W - 230V ØINT: 185mm - ØEXT: 200mm 215X30 mm
	OVEN	HEATING ELEMENT 3300W - 230V INNØ: 185mm - EXTØ: 200mm 215X30 mm

Código fabricante / Manufacturer Code **808778**

	Referencia Code	<b>22225</b> ORIGINAL
	HORNO	RESISTENCIA 3500W - 230V 620X120X33 mm
	OVEN	HEATING ELEMENT 3500W - 230V 620X120X33 mm

Código fabricante / Manufacturer Code **808780**

## EMMEPI

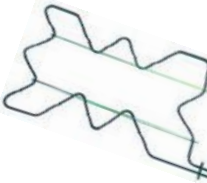
	Referencia Code	<b>19530</b> ORIGINAL
	HORNO	RESISTENCIA 4000W - 230V 860X500mm
	OVEN	HEATING ELEMENT 4000W - 230V 860X500mm

Código fabricante / Manufacturer Code **C10195**

	Referencia Code	<b>22220</b> ORIGINAL
	HORNO	RESISTENCIA 6000W - 230V ØINT: 217mm - ØEXT: 231 mm 271X90 mm
	OVEN:	HEATING ELEMENT 6000W - 230V INNØ: 217mm - EXTØ: 231 mm 271X90 mm

Código fabricante / Manufacturer Code **808781**

	Referencia Code	<b>22178</b> ORIGINAL
	HORNO	RESISTENCIA 7500W - 230V 295X34X45 mm
	OVEN	HEATING ELEMENT 7500W - 230V 295X34x45 mm

\*CÓDIGO JUNTA / GASKET CODE  
90808

Código fabricante / Manufacturer Code **808781**

	Referencia Code	<b>23973</b> ORIGINAL
	HORNO	RESISTENCIA 9000W - 230V 205X38X70 mm
	OVEN	HEATING ELEMENT 9000W - 230V 205X38x70 mm

\*CÓDIGO JUNTA / GASKET CODE  
23912

Código fabricante / Manufacturer Code **809556**



# RESISTENCIAS HORNO / OVEN HEATING ELEMENTS

## EMMEPI

	Referencia Code	<b>23992</b> ORIGINAL
		RESISTENCIA 9000W - 230V ØINT: 445mm - ØEXT: 458 mm 474X130 mm
	HORNO	• • • HEATING ELEMENT 9000W - 230V INNØ: 445mm - EXTØ: 458 mm 474X130 mm
OVEN		
Código fabricante / Manufacturer Code		809555

	Referencia Code	<b>23993</b> ORIGINAL
		RESISTENCIA 9000W - 230V ØINT: 504mm - ØEXT: 516 mm 535X130 mm
	HORNO	• • • HEATING ELEMENT 9000W - 230V INNØ: 504mm - EXTØ: 516 mm 535X130 mm
OVEN		
Código fabricante / Manufacturer Code		809554

	Referencia Code	<b>23994</b> ORIGINAL
		RESISTENCIA INTERIOR 15000W - 230V ØINT: 505mm - ØEXT: 520 mm 615X180 mm
	HORNO	• • • INNER HEATING ELEMENT 15000W - 230V INNØ: 505mm - EXTØ: 520 mm 615X180 mm
OVEN		
Código fabricante / Manufacturer Code		809571

	Referencia Code	<b>23995</b> ORIGINAL
		RESISTENCIA INTERIOR 15000W - 230V ØINT: 635mm - ØEXT: 650 mm 696X200 mm
	HORNO	• • • INNER HEATING ELEMENT 15000W - 230V INNØ: 635mm - EXTØ: 650 mm 696X200 mm
OVEN		
Código fabricante / Manufacturer Code		809570

## EURAST

	Referencia Code	<b>24859</b> ORIGINAL
		RESISTENCIA 2000W - 230V
	HORNO: UNIC	• • • HEATING ELEMENT 2000W - 230V
OVEN: UNIC		
Código fabricante / Manufacturer Code		1E221049

	Referencia Code	<b>84190</b> ORIGINAL
		RESISTENCIA 8400W - 230V
	HORNO: 5GN	• • • HEATING ELEMENT 8400W - 230V
OVEN: 5GN		
Código fabricante / Manufacturer Code		9600201

## EUROFRED

	Referencia Code	<b>32604</b> STANDARD
		RESISTENCIA 3300W - 230V Ø192X223 mm
	HORNO	• • • HEATING ELEMENT 3300W - 230V Ø192X223 mm
OVEN		

## FAGOR

	Referencia Code	<b>16801</b> ORIGINAL
		RESISTENCIA 1000W - 230V 515X125 mm
	HORNO: CE7841, CE9-41, CGE9-41 HE9-10, HE9-20	• • • HEATING ELEMENT 1000W - 230V 515X125 mm
OVEN: CE7841, CE9-41, CGE9-41 HE9-10, HE9-20		
Código fabricante / Manufacturer		U803004000

# RESISTENCIAS HORNO / OVEN HEATING ELEMENTS

## FAGOR

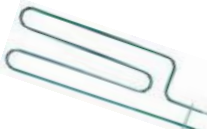
	Referencia Code	<b>20264</b> ORIGINAL
		RESISTENCIA 1000W - 230V 515X170 mm
	HORNO:	CE941
		HEATING ELEMENT 1000W - 230V 515X170 mm
	OVEN:	CE941

Código fabricante / Manufacturer Code **U183030000**

	Referencia Code	<b>87205</b> STANDARD
		RESISTENCIA 1100W - 230V 290X312X50 mm
	HORNO:	
		HEATING ELEMENT 1100W - 230V 290X312X50 mm
	OVEN:	

	Referencia Code	<b>87202</b> STANDARD
		RESISTENCIA 1400W+700W - 230V 350X320X24 mm
	HORNO:	
		HEATING ELEMENT 1400W+700W - 230V 350X320X24 mm
	OVEN:	

	Referencia Code	<b>10010</b> ORIGINAL
		RESISTENCIA 1500W - 230V 350X80 mm
	HORNO:	HMM6/11
		HEATING ELEMENT 1500W - 230V 350X80 mm
	OVEN:	HMM6/11

Código fabricante / Manufacturer Code **R663016000**

## FAGOR

	Referencia Code	<b>13547</b> ORIGINAL
		RESISTENCIA 1500W - 230V 455X50X25 mm
	HORNO:	
		HEATING ELEMENT 1500W - 230V 455X50X25 mm
	OVEN:	

Código fabricante / Manufacturer Code **Z776391000**

	Referencia Code	<b>87213</b> STANDARD
		RESISTENCIA 1900W - 230V 320X291 mm
	HORNO:	
		HEATING ELEMENT 1900W - 230V 320X291 mm
	OVEN:	

	Referencia Code	<b>10258</b> STANDARD
		RESISTENCIA 2250W - 230V 230X232 mm
	HORNO:	
		HEATING ELEMENT 2250W - 230V 230X232 mm
	OVEN:	

	Referencia Code	<b>7981</b> ORIGINAL
		RESISTENCIA 3000W - 230V 455X50X25 mm
	HORNO:	
		HEATING ELEMENT 1500W - 230V 455X50X25 mm
	OVEN:	

Código fabricante / Manufacturer Code **R673002000**

# RESISTENCIAS HORNO / OVEN HEATING ELEMENTS

## FAGOR

Referencia Code **10582** ORIGINAL



RESISTENCIA  
4000W - 230V  
570X70 mm

HORNO: HMM, HME, HMP

• • •

HEATING ELEMENT  
4000W - 230V  
570X70 mm

OVEN: HMM, HME, HMP

Código fabricante / Manufacturer Code **R68300000**

Referencia Code **20265** ORIGINAL



RESISTENCIA  
4000W - 230V  
1155X100 mm

HORNO: HMM20, HMM21

• • •

HEATING ELEMENT  
4000W - 230V  
1155X100 mm

OVEN: HMM20, HMM21

Código fabricante / Manufacturer Code **R093002000**

Referencia Code **13550** ORIGINAL

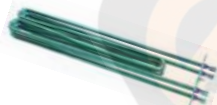

RESISTENCIA  
9000W - 230V  
350X75X28 mm

HORNO: HMM\_, HME\_, HMP\_

• • •

HEATING ELEMENT  
9000W - 230V  
350X75X28 mm

OVEN: HMM\_, HME\_, HMP\_

\*CÓDIGO JUNTA / GASKET CODE  
13559

Código fabricante / Manufacturer Code **R143000000**

Referencia Code **23973** ORIGINAL



RESISTENCIA  
9000W - 230V  
205X38X70 mm

HORNO: HMM\_, HME\_, HMP\_

• • •

HEATING ELEMENT  
9000W - 230V  
350X75X28 mm

OVEN: HMM\_, HME\_, HMP\_

\*CÓDIGO JUNTA / GASKET CODE  
23912

Código fabricante / Manufacturer Code **RT32011004, RT32011009**

## FAGOR

Referencia Code **23992** ORIGINAL



RESISTENCIA  
9000W - 230V  
ØINT: 445 mm - ØEXT: 458 mm  
474X130 mm

HORNO

• • •

HEATING ELEMENT  
9000W - 230V  
INNØ: 445 mm - EXTØ: 458 mm  
474X130 mm

OVEN

Código fabricante / Manufacturer Code **RT32001000**

Referencia Code **23993** ORIGINAL



RESISTENCIA  
9000W - 230V  
ØINT: 504 mm - ØEXT: 516 mm  
535X130 mm

HORNO

• • •

HEATING ELEMENT  
9000W - 230V  
INNØ: 504 mm - EXTØ: 516 mm  
535X130 mm

OVEN

Código fabricante / Manufacturer Code **RT32001001, RT32001009**

Referencia Code **23994** ORIGINAL



RESISTENCIA INTERIOR  
15000W - 230V  
ØINT: 505 mm - ØEXT: 520 mm  
615X180 mm

HORNO

• • •

INNER HEATING ELEMENT  
15000W - 230V  
INNØ: 505 mm - EXTØ: 520 mm  
615X180 mm

OVEN

Código fabricante / Manufacturer Code **RT32001002, RT32001013**

Referencia Code **23995** ORIGINAL



RESISTENCIA INTERIOR  
15000W - 230V  
ØINT: 505 mm - ØEXT: 520 mm  
615X180 mm

HORNO

• • •

INNER HEATING ELEMENT  
15000W - 230V  
INNØ: 505 mm - EXTØ: 520 mm  
615X180 mm

OVEN

Código fabricante / Manufacturer Code **RT32001003, RT32001017**

# RESISTENCIAS HORNO / OVEN HEATING ELEMENTS

## FAGOR



Referencia Code **90160** ORIGINAL

RESISTENCIA  
18000W - 230V  
194X87X68 mm

HORNO



HEATING ELEMENT  
18000W - 230V  
194X87X68 mm

OVEN

\*CÓDIGO JUNTA / GASKET CODE  
68264

Código fabricante / Manufacturer Code **RT4400195**

## FIMOR



Referencia Code **50591** ORIGINAL

RESISTENCIA  
4000W - 230V

HORNO



HEATING ELEMENT  
4000W - 230V

OVEN

Código fabricante / Manufacturer Code **200001126**

## FOINOX



Referencia Code **22227** ORIGINAL

RESISTENCIA  
3000W - 230V  
220X65 mm

HORNO: JO1011E, JO1021E, JO2011E,  
FM100EEP, FM100EM, FM100ETD,  
FM200EEP, FM200EM, FM200ETD,  
FM201EM, FM201EEP, FM201ETD



HEATING ELEMENT  
3000W - 230V  
220X65 mm

OVEN: JO1011E, JO1021E, JO2011E,  
FM100EEP, FM100EM, FM100ETD,  
FM200EEP, FM200EM, FM200ETD,  
FM201EM, FM201EEP, FM201ETD

Código fabricante / Manufacturer Code **10622**

## FOINOX



Referencia Code **22225** ORIGINAL

RESISTENCIA  
3500W - 230V  
620X120X33 mm

HORNO: FC12SE, FC12SEA, FC20E,  
FC20EA, FM10E, FM10EB, FM10EDG,  
FM20EB, FP10E, FP10EA, MM10EA,  
MM10EB, MM20EA, MM20EB



HEATING ELEMENT  
3500W - 230V  
620X120X33 mm

OVEN: FC12SE, FC12SEA, FC20E, FC20EA,  
FM10E, FM10EB, FM10EDG, FM20EB,  
FP10E, FP10EA, MM10EA, MM10EB,  
MM20EA, MM20EB

Código fabricante / Manufacturer Code **1466**

Referencia Code **22220** ORIGINAL

RESISTENCIA  
6000W - 230V  
ØINT: 217 mm - ØEXT: 231 mm  
271X90 mm

HORNO

HEATING ELEMENT  
6000W - 230V  
INNØ: 217 mm - EXTØ: 231 mm  
271X90 mm

OVEN

Código fabricante / Manufacturer Code **1023**

Referencia Code **80257** ORIGINAL

RESISTENCIA  
8000W - 230V  
ØINT: 287 mm - ØEXT: 300 mm  
345X90 mm

HORNO: FC60EEP, FC60EM, FC60ETD,  
FM60EEP, FDE10\_155EP, FM60EM,  
FM60ETD, FP50EEP, FDE10\_155M,  
FDE10\_155TD, FDE55EP, FDE55M, FDE55TD,  
FP50EM, MM60ED, MM60EEP, MM60EM,  
MM60ETD



HEATING ELEMENT  
8000W - 230V  
INNØ: 287 mm - EXTØ: 300 mm  
345X90 mm

OVEN: FC60EEP, FC60EM, FC60ETD,  
FM60EEP, FDE10\_155EP, FM60EM,  
FM60ETD, FP50EEP, FDE10\_155M,  
FDE10\_155TD, FDE55EP, FDE55M, FDE55TD,  
FP50EM, MM60ED, MM60EEP, MM60EM,  
MM60ETD

Código fabricante / Manufacturer Code **10628**

# RESISTENCIAS HORNO / OVEN HEATING ELEMENTS

## FOINOX

Referencia  
Code **22221** ORIGINAL



RESISTENCIA  
8000W - 230V  
ØINT: 250 mm - ØEXT: 265 mm  
277X75 mm

**HORNO:** FC06SE, FM06EB, FM06EDG,  
FPO5E, FPO5EA, MM06EA, MM06EB,  
M06EBM

HEATING ELEMENT  
8000W - 230V  
INNØ: 250 mm - EXTØ: 265 mm  
277X75 mm

**OVEN:** FC06SE, FM06EB, FM06EDG,  
FPO5E, FPO5EA, MM06EA, MM06EB,  
M06EBM

Código fabricante / Manufacturer Code **3016**

## GARBIN

Referencia  
Code **48276** ORIGINAL



RESISTENCIA  
SUPERIOR  
2400W - 230V  
330X300 mm

**HORNO:** 23MX, 23MXUMI, 43MX,  
43MXUMI

HEATING ELEMENT  
2400W - 230V  
330X300 mm

**OVEN:** 23MX, 23MXUMI, 43MX,  
43MXUMI

Código fabricante / Manufacturer Code **RES008, RES039, RESSUP234MX**

Referencia  
Code **19605** ORIGINAL



RESISTENCIA  
INFERIOR  
2500W - 230V  
ØINT: 178 mm - ØEXT: 190 mm  
242X35 mm

**HORNO:** 12GX, 23MX, 23MXUMI, 43MX,  
43MXUMI

HEATING ELEMENT  
2500W - 230V  
INNØ: 178 mm - EXTØ: 190 mm  
242X35 mm

**OVEN:** 12GX, 23MX, 23MXUMI, 43MX,  
43MXUMI

Código fabricante / Manufacturer Code **RES036**

## GARBIN

Referencia  
Code **49577** ORIGINAL



RESISTENCIA  
4000W - 230V  
ØINT: 185 mm - ØEXT: 200 mm

**HORNO:** 36EXVAPOR, 31EXVAPOR,  
36PXUMI, 31GXUMI

HEATING ELEMENT  
4000W - 230V  
INNØ: 185 mm - EXTØ: 200 mm

**OVEN:** 36EXVAPOR, 31EXVAPOR,  
36PXUMI, 31GXUMI

Código fabricante / Manufacturer Code **RES000, RES36, RES4000**

## GAYC

Referencia  
Code **51028** ORIGINAL



RESISTENCIA  
1200W - 230V  
Ø190X65 mm

**HORNO:** G2

HEATING ELEMENT  
1200W - 230V  
Ø190X65 mm

**OVEN:** G2

Código fabricante / Manufacturer Code **12507620, 12420180**

Referencia  
Code **16685** ORIGINAL



RESISTENCIA  
2250W - 230V  
Ø190 mm

**HORNO**

HEATING ELEMENT  
2250W - 230V  
Ø190 mm

**OVEN**

Código fabricante / Manufacturer Code **12575200**

Referencia  
Code **16684** STANDARD



RESISTENCIA  
3500W - 230V  
Ø210 mm

**HORNO**

HEATING ELEMENT  
3500W - 230V  
Ø210 mm

**OVEN**

# RESISTENCIAS HORNO / OVEN HEATING ELEMENTS

## GIGA

	Referencia Code	<b>22180</b> ORIGINAL
		RESISTENCIA 990W - 230V 475X106X24 mm
	<b>HORNO</b>	..... HEATING ELEMENT 990W - 230V 475X106X24 mm
	<b>OVEN</b>	

Código fabricante / Manufacturer Code **X47000**

	Referencia Code	<b>22179</b> ORIGINAL
		RESISTENCIA 1500W - 230V 365X500 mm
	<b>HORNO:</b> C_FFLEP, C_PFLE, CFFLE, CC81E, CCQ81E, CC120E, CCQ120E, CCG81E, CCG120E, SKC_FFE, CCV81E, C4VFLE	..... HEATING ELEMENT 1500W - 230V 365X500 mm
	<b>OVEN:</b> C_FFLEP, C_PFLE, CFFLE, CC81E, CCQ81E, CC120E, CCQ120E, CCG81E, CCG120E, SKC_FFE, CCV81E, C4VFLE	

Código fabricante / Manufacturer Code **X68203**

	Referencia Code	<b>19605</b> ORIGINAL
		RESISTENCIA 2500W - 230V ØINT: 178 mm - ØEXT: 190 mm 242X35 mm
	<b>HORNO:</b> CC80E, CCQ80E, CCV81E, SKC40G, SKC80G	..... HEATING ELEMENT 2500W - 230V INNØ: 178 mm - EXTØ: 190 mm 242X35 mm
	<b>OVEN:</b> CC80E, CCQ80E, CCV81E, SKC40G, SKC80G	

Código fabricante / Manufacturer Code **X68002**

## GIGA

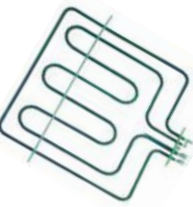
	Referencia Code	<b>19604</b> ORIGINAL
		RESISTENCIA 2600W - 230V 350X355 mm
	<b>HORNO:</b> C_FFLEP, C_PFLE, CFFLE, CC81E, CCQ81E, CC120E, CCQ120E, CCG81E, CCG120E, SKC_FFE, CCV81E, C4VFLE	..... HEATING ELEMENT 2600W - 230V 350X355 mm
	<b>OVEN:</b> C_FFLEP, C_PFLE, CFFLE, CC81E, CCQ81E, CC120E, CCQ120E, CCG81E, CCG120E, SKC_FFE, CCV81E, C4VFLE	

Código fabricante / Manufacturer Code **X68202**

	Referencia Code	<b>22229</b> ORIGINAL
		RESISTENCIA 5400W - 230V ØINT: 194 mm - ØEXT: 205 mm 270X85 mm
	<b>HORNO</b>	..... HEATING ELEMENT 5400W - 230V INNØ: 194 mm - EXTØ: 205 mm 270X85 mm
	<b>OVEN</b>	

Código fabricante / Manufacturer Code **760978**

	Referencia Code	<b>22230</b> ORIGINAL
		RESISTENCIA 6000W - 230V ØINT: 217 mm - ØEXT: 230 mm 267X75 mm
	<b>HORNO</b>	..... HEATING ELEMENT 6000W - 230V INNØ: 217 mm - EXTØ: 230 mm 267X75 mm
	<b>OVEN</b>	

Código fabricante / Manufacturer Code **761344, R33400, R65010530**

# RESISTENCIAS HORNO / OVEN HEATING ELEMENTS

## GIORIK

	Referencia Code <b>22178</b> ORIGINAL
	RESISTENCIA 7500W - 230V 295X34x45 mm  HORNO: _V_0061, _V_0101, _V_0102  HEATING ELEMENT 7500W - 230V 295X34x45 mm  OVEN: _V_0061, _V_0101, _V_0102
*CÓDIGO JUNTA / GASKET CODE 90808	
Código fabricante / Manufacturer Code <b>6003290</b>	

	Referencia Code <b>88785</b> ORIGINAL
	RESISTENCIA 8400W - 230V ØINT: 218 mm - ØEXT: 235 mm 275X112 mm  HORNO: _0061  HEATING ELEMENT 8400W - 230V INNØ: 218 mm - EXTØ: 235 mm 275X112 mm  OVEN: _0061
Código fabricante / Manufacturer Code <b>6002001</b>	

	Referencia Code <b>90109</b> ORIGINAL
	RESISTENCIA 25000W - 400V ØINT: 388 mm - ØEXT: 406 mm 452X150 mm  HORNO: _0102  HEATING ELEMENT 8400W - 230V INNØ: 388 mm - EXTØ: 406 mm 452X150 mm  OVEN: _0102
Código fabricante / Manufacturer Code <b>6002121</b>	

## INOXTREND

	Referencia Code <b>85597</b> ORIGINAL
	RESISTENCIA 8000W - 230V Ø320 mm  HORNO  HEATING ELEMENT 8000W - 230V Ø320 mm  OVEN
Código fabricante / Manufacturer Code <b>IDRELCO02</b>	

## JUNO-RÖDER-SENKING

	Referencia Code <b>22272</b> ORIGINAL
	RESISTENCIA 4500W - 230V 534X350X70 mm  HORNO  HEATING ELEMENT 4500W - 230V 534X350X70 mm  OVEN
Código fabricante / Manufacturer Code <b>02757</b>	

	Referencia Code <b>22267</b> ORIGINAL
	RESISTENCIA 8000W - 400V ØINT: 560 mm - ØEXT: 580 mm 630X68 mm  HORNO  HEATING ELEMENT 8000W - 400V INNØ: 560 mm - EXTØ: 580 mm 630X68 mm  OVEN
Código fabricante / Manufacturer Code <b>214100, A5330</b>	

	Referencia Code <b>22285</b> ORIGINAL
	RESISTENCIA 17000W - 230V 590X29X38 mm  HORNO  HEATING ELEMENT 17000W - 230V 590X29X38 mm  OVEN
Código fabricante / Manufacturer Code <b>58995</b>	

## KUPPERSBUSCH

	Referencia Code <b>85071</b> ORIGINAL
	RESISTENCIA 4800W - 400V ØINT: 183 mm - ØEXT: 213 mm 265X33 mm  HORNO: ECL484  HEATING ELEMENT 4800W - 400V ØINT: 183 mm - ØEXT: 213 mm 265X33 mm  OVEN: ECL484
Código fabricante / Manufacturer Code <b>182662</b>	

# RESISTENCIAS HORNO / OVEN HEATING ELEMENTS

## LAINOX

Referencia Code **28287** ORIGINAL

RESISTENCIA  
900W - 230V  
545X90 mm

HORNO: PG108D/M

HEATING ELEMENT  
900W - 230V  
545X90 mm

OVEN: PG108D/M



Código fabricante / Manufacturer Code **R65021100**

Referencia Code **22242** ORIGINAL

RESISTENCIA  
1800W - 230V  
534X120 mm

HORNO: ME15, MME15, PE12EL, PE12MEC

HEATING ELEMENT  
1800W - 230V  
534X120 mm

OVEN: ME15, MME15, PE12EL, PE12MEC



Código fabricante / Manufacturer Code **53003130, 50303160, R65010110**

Referencia Code **22240** ORIGINAL

RESISTENCIA  
2500W - 230V  
655X120 mm

HORNO: FE110M, FE110X, PE080M, PE080X, ME10, FE101M, FE101X, PE101M, PE101X, PE081M, PE081X, ME21, MME10, MME21, PE08, RE10

HEATING ELEMENT  
2500W - 230V  
655X120 mm

OVEN: FE110M, FE110X, PE080M, PE080X, ME10, FE101M, FE101X, PE101M, PE101X, PE081M, PE081X, ME21, MME10, MME21, PE08, RE10

**R50303150, R50303860, R65010130,**

Código fabricante / Manufacturer Code **R65010140, R65010141, R65010180,**

**R65015300, R65015310**



Referencia Code **22232** ORIGINAL

RESISTENCIA  
3150W - 230V  
ØINT: 201 mm - ØEXT: 215 mm  
272X35 mm

HORNO

HEATING ELEMENT  
3150W - 230V  
INNØ: 201 mm - EXTØ: 215 mm  
272X35 mm

OVEN



Código fabricante / Manufacturer Code **A34300510, R65010300, R65010320**

## LAINOX

Referencia Code **22248** ORIGINAL

RESISTENCIA  
3150W - 230V  
240X54X54 mm

HORNO: ME004

HEATING ELEMENT  
3150W - 230V  
240X54X54 mm

OVEN: ME004



\*CÓDIGO JUNTA / GASKET CODE  
90808

Código fabricante / Manufacturer Code **R65020120**

Referencia Code **22241** ORIGINAL

RESISTENCIA  
3500W - 230V  
655X120 mm

HORNO: FE210M, FE210X, FE102X, FE102M, ME20, ME24, ME40, MME20, MME24, RE20, RE24, RE40

HEATING ELEMENT  
3500W - 230V  
655X120 mm

OVEN: FE210M, FE210X, FE102X, FE102M, ME20, ME24, ME40, MME20, MME24, MME40, RE20, RE24, RE40



Código fabricante / Manufacturer Code **65010390**

Referencia Code **22233** ORIGINAL

RESISTENCIA  
3900W - 230V  
ØINT: 176 mm - ØEXT: 244 mm  
282X43 mm

HORNO: VE104D, VE104X, VE104M, VE104H, VE104S

HEATING ELEMENT  
3900W - 230V  
INNØ: 176 mm - ØEXT: 244 mm  
282X43 mm

OVEN: VE104D, VE104X, VE104M, VE104H, VE104S



Código fabricante / Manufacturer Code **65010450**

Referencia Code **22249** ORIGINAL

RESISTENCIA  
3900W - 230V  
230X35X49 mm

HORNO: ME104

HEATING ELEMENT  
3900W - 230V  
230X35X49 mm

OVEN: ME104



\*CÓDIGO JUNTA / GASKET CODE  
90808

Código fabricante / Manufacturer Code **65020190**



# RESISTENCIAS HORNO / OVEN HEATING ELEMENTS

## LAINOX

Referencia  
Code **22229** ORIGINAL



RESISTENCIA  
5400W - 230V  
ØINT: 194 mm - ØEXT: 205 mm  
270X85 mm

HORNO: FE/5

HEATING ELEMENT  
5400W - 230V  
INNØ: 194 mm - EXTØ: 205 mm  
270X85 mm

OVEN: FE/5

Código fabricante / Manufacturer Code **65011500**

Referencia  
Code **22220** ORIGINAL



RESISTENCIA  
6000W - 230V  
ØINT: 217 mm - ØEXT: 231 mm  
271X90 mm

HORNO

HEATING ELEMENT  
6000W - 230V  
INNØ: 217 mm EXTØ: 231 mm  
271X90 mm

OVEN

Código fabricante / Manufacturer Code **R65011530**

Referencia  
Code **22230** ORIGINAL



RESISTENCIA  
6000W - 230V  
ØINT: 217 mm - ØEXT: 230 mm  
267X75 mm

HORNO: CE051M, MCE051M, MVE051P,  
VE051P, VE055P, HME061P, HME061X,  
ME05, MME05, ME105S, ME105L, VE105S

HEATING ELEMENT  
6000W - 230V  
INNØ: 217 mm - EXTØ: 230 mm  
267X72 mm

OVEN: CE051M, MCE051M, MVE051P,  
VE051P, VE055P, HME061P, HME061X,  
ME05, MME05, ME105S, ME105L, VE105S

Código fabricante / Manufacturer Code **R50303270, R50303280, R50303820,  
R65011520, R65015910, R65015920**

Referencia  
Code **22247** ORIGINAL



RESISTENCIA  
6000W - 230V  
338X371X50 mm

HORNO: FV03, FV06, ME05, ME10, ME15,  
ME20, ME21, ME24, ME40, MME05,  
MME10, MME15, MME20, MME21, MME24,  
MME40, ME105S, ME105L

HEATING ELEMENT  
6000W - 230V  
338X371X50 mm

OVEN: FV03, FV06, ME05, ME10, ME15,  
ME20, ME21, ME24, ME40, MME05,  
MME10, MME15, MME20, MME21, MME24,  
MME40, ME105S, ME105L

\*CÓDIGO JUNTA / GASKET CODE  
90808

Código fabricante / Manufacturer Code

**50303250, R65020270  
R65020280, R65025100**

## LAINOX

Referencia  
Code **22231** ORIGINAL



RESISTENCIA  
7200W - 230V  
ØINT: 215 mm - ØEXT: 230 mm  
270X78mm

HORNO: FE105M, FE105X, PE040M,  
PE040X, FE051M, FE051X, PE041M,  
PE041X, PE051M, PE051X, FE05, PE04,  
PE05

HEATING ELEMENT  
7200W - 230V  
INNØ: 215 mm - EXTØ: 230 mm  
270X78mm

OVEN: FE105M, FE105X, PE040M, PE040X,  
FE051M, FE051X, PE041M, PE041X,  
PE051M, PE051X, FE05, PE04, PE05

Código fabricante / Manufacturer Code **50303580, 50303830, R65010680,  
R65016010, R65016020**

Referencia  
Code **22235** ORIGINAL



RESISTENCIA  
7500W - 230V  
ØINT: 248 mm - ØEXT: 260 mm  
287X88mm

HORNO: CE071M, ME061D, ME061M,  
ME061P, ME061T, VE061D, VE061P,  
VE061M, VE106M, VE106P, VE106H,  
VE106D, VE106X, ME106M, ME106P,  
ME106H, ME106D, ME106X, ME061H,  
CE106M, ME106S, ME106L, ME106T,  
VE106S, VE106L, VE106T

HEATING ELEMENT  
7500W - 230V  
ØINT: 248 mm - ØEXT: 260 mm  
287X88mm

OVEN: CE071M, ME061D, ME061M,  
ME061P, ME061T, VE061D, VE061P,  
VE061M, VE106M, VE106P, VE106H,  
VE106D, VE106X, ME106M, ME106P,  
ME106H, ME106D, ME106X, ME061H,  
CE106M, ME106S, ME106L, ME106T,  
VE106S, VE106L, VE106T

Código fabricante / Manufacturer Code **R56010570, R65010570  
R65010580, 65011540**

Referencia  
Code **22243** ORIGINAL



RESISTENCIA DERECHA  
7500W - 230V  
560X255X135 mm

HORNO: ME110S, ME110L, ME110T,  
ME120S, ME120L, ME120T, VE110S,  
VE110T

RIGHT HEATING ELEMENT  
7500W - 230V  
560X255X135 mm

OVEN: ME110S, ME110L, ME110T,  
ME120S, ME120L, ME120T, VE110S,  
VE110T

Código fabricante / Manufacturer Code **R65010610, R65010630, R65011580**

# RESISTENCIAS HORNO / OVEN HEATING ELEMENTS

## LAINOX

Referencia  
Code **22244** ORIGINAL



RESISTENCIA  
7500W - 230V  
525X250X130 mm

**HORNO:** ME110S, ME110L, ME110T,  
ME120S, ME120L, ME120T, VE110S,  
VE110T

HEATING ELEMENT  
7500W - 230V  
525X250X130 mm

**OVEN:** ME110S, ME110L, ME110T,  
ME120S, ME120L, ME120T, VE110S,  
VE110T

Código fabricante / Manufacturer Code **R65010620, R65010640, R65011590**

Referencia  
Code **22251** ORIGINAL



RESISTENCIA  
7500W - 230V  
365X36X50 mm

**HORNO:** ME061D, ME061M, ME061P,  
ME061T, ME101D, ME101M, ME106T,  
ME110S, ME110L, ME110T, ME120S,  
ME120L, ME120T, ME210S, ME210L,  
ME210T

HEATING ELEMENT  
7500W - 230V  
365X36X50 mm

**OVEN:** ME061D, ME061M, ME061P,  
ME061T, ME101D, ME101M, ME106T,  
ME110S, ME110L, ME110T, ME120S,  
ME120L, ME120T, ME210S, ME210L,  
ME210T

\*CÓDIGO JUNTA / GASKET CODE  
7358

Código fabricante / Manufacturer Code

**R50303890, R65020320  
R65020330, R65020350**

Referencia  
Code **86129** ORIGINAL



RESISTENCIA  
7500W - 230V  
365X45 mm

**HORNO:** FV/6

HEATING ELEMENT  
7500W - 230V  
365X45 mm

**OVEN:** FV/6

\*CÓDIGO JUNTA / GASKET CODE  
7358

Código fabricante / Manufacturer Code

**R65020340**

Referencia  
Code **22237** ORIGINAL



RESISTENCIA  
9000W - 230V  
ØINT: 508 mm - ØEXT: 526 mm  
550X122 mm

**HORNO:** ME210, ME220, VE210, VE220,  
SERIE M, D, H, P, X

HEATING ELEMENT  
9000W - 230V  
INNØ: 508 mm - EXTØ: 526 mm  
550X122 mm

**OVEN:** ME210, ME220, VE210, VE220, SE-  
RIES M, D, H, P, X

Código fabricante / Manufacturer Code

**R65020340**

## LAINOX

Referencia  
Code **22245** ORIGINAL



RESISTENCIA  
12000W - 230V  
520X255X135mm

**HORNO:** ME210S, ME210L, ME210T,  
ME220S, ME220L, ME220T, VE210S,  
VE210L, VE210T

HEATING ELEMENT  
12000W - 230V  
520X255X135mm

**OVEN:** ME210S, ME210L, ME210T,  
ME220S, ME220L, ME220T, VE210S,  
VE210L, VE210T

Código fabricante / Manufacturer Code **R65010870, R65010890, R65011610**

Referencia  
Code **22246** ORIGINAL



RESISTENCIA  
12000W - 230V  
540X260X135mm

**HORNO:** ME210S, ME210L, ME210T,  
ME220S, ME220L, ME220T, VE210S,  
VE210L, VE210T

HEATING ELEMENT  
12000W - 230V  
540X260X135mm

**OVEN:** ME210S, ME210L, ME210T,  
ME220S, ME220L, ME220T, VE210S,  
VE210L, VE210T

Código fabricante / Manufacturer Code **R65010880, R65010900, R65011620**

Referencia  
Code **22236** ORIGINAL



RESISTENCIA  
15000W - 230V  
ØINT: 338 mm - ØEXT: 408 mm  
428X132mm

**HORNO:** SERIE ME, MES, VE, VES

HEATING ELEMENT  
15000W - 230V  
INNØ: 338 mm - EXTØ: 408 mm  
428X132mm

**OVEN:** SERIES ME, MES, VE, VES

Código fabricante / Manufacturer Code

**R65011310**

# RESISTENCIAS HORNO / OVEN HEATING ELEMENTS

## LAINOX

	Referencia Code <b>22238</b> ORIGINAL
	RESISTENCIA 15000W - 230V ØINT: 512 mm - ØEXT: 530 mm 545X130 mm <b>HORNO:</b> HME102P, HME102T, HME102X, HME202P, HME202T, HME202X, HVE102P, HVE102T, HVE102X, HVE202P, HVE202T, HVE202X • • • HEATING ELEMENT 15000W - 230V INNØ: 512 mm - EXTØ: 530 mm 545X130 mm <b>OVEN:</b> HME102P, HME102T, HME102X, HME202P, HME202T, HME202X, HVE102P, HVE102T, HVE102X, HVE202P, HVE202T, HVE202X
	Código fabricante / Manufacturer Code <b>R65011250</b>

	Referencia Code <b>22252</b> ORIGINAL
	RESISTENCIA 15000W - 230V 530X45X30 mm <b>HORNO:</b> ME102D, ME102M, ME102P, ME102T, ME201D, ME102H • • • HEATING ELEMENT 15000W - 230V 530X45X30 mm <b>OVEN:</b> ME102D, ME102M, ME102P, ME102T, ME201D, ME102H
	Código fabricante / Manufacturer Code <b>R65020390, R65020400 R65020420, R65020421</b>

## LOTUS

	Referencia Code <b>19766</b> ORIGINAL
	RESISTENCIA 700W - 230V 505X125 mm / M12X1 <b>HORNO:</b> SERIE 700 • • • HEATING ELEMENT 700W - 230V 505X125 mm / M12X1 <b>OVEN:</b> SERIE 700
	Código fabricante / Manufacturer Code <b>53.7.0254.00</b>

	Referencia Code <b>19769</b> ORIGINAL
	RESISTENCIA 750W - 230V 373X327 mm / M12X1 <b>HORNO:</b> TS1 • • • HEATING ELEMENT 750W - 230V 373X327 mm / M12X1 <b>OVEN:</b> TS1
	Código fabricante / Manufacturer Code <b>53.7.0032.00</b>

## LOTUS

	Referencia Code <b>19767</b> ORIGINAL
	RESISTENCIA 800W - 230V 685X125 mm / M12X1 <b>HORNO:</b> SERIE 900 • • • HEATING ELEMENT 800W - 230V 685X125 mm / M12X1 <b>OVEN:</b> SERIE 900
	Código fabricante / Manufacturer Code <b>53.7.0278.00</b>

	Referencia Code <b>19765</b> ORIGINAL
	RESISTENCIA 1200W - 230V 505X123 mm / M12X1 <b>HORNO:</b> SERIE 700 • • • HEATING ELEMENT 1200W - 230V 505X123 mm / M12X1 <b>OVEN:</b> SERIE 700
	Código fabricante / Manufacturer Code <b>53.7.0209.01, 53.7.0209.00</b>

	Referencia Code <b>19764</b> ORIGINAL
	RESISTENCIA 1600W - 230V 300X530 mm <b>HORNO:</b> SERIE 60, SERIE 65, CF8, CF10 • • • HEATING ELEMENT 1600W - 230V 300X530 mm <b>OVEN:</b> SERIES 60, SERIES 65, CF8, CF10
	Código fabricante / Manufacturer Code <b>53.7.0063.00</b>

	Referencia Code <b>19768</b> ORIGINAL
	RESISTENCIA 1700W - 230V 690X125 mm / M12X1 <b>HORNO:</b> SERIE 900 • • • HEATING ELEMENT 1700W - 230V 690X125 mm / M12X1 <b>OVEN:</b> SERIE 900
	Código fabricante / Manufacturer Code <b>53.7.0281.00</b>

# RESISTENCIAS HORNO / OVEN HEATING ELEMENTS

## LOTUS

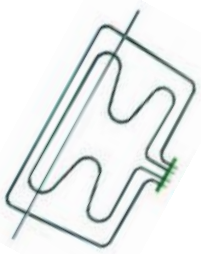
	Referencia Code	<b>19763</b> ORIGINAL
		RESISTENCIA 3050W - 230V 325X474X40 mm
	HORNO:	SERIE 60, SERIE 65
		HEATING ELEMENT 3050W - 230V 325X474X40 mm
	OVEN:	SERIES 60, SERIES 65
Código fabricante / Manufacturer Code		53.7.0062.00

## MARENO

	Referencia Code	<b>19882</b> ORIGINAL
		RESISTENCIA 1200W - 230V 346X342 mm
	HORNO:	FOE-60M
		HEATING ELEMENT 1200W - 230V 346X342 mm
	OVEN:	FOE-60M
Código fabricante / Manufacturer Code		10.37302400

## MARENO

	Referencia Code	<b>19885</b> ORIGINAL
		RESISTENCIA 750W - 230V 483X64X21 mm
	HORNO:	C70-EFE, C70-EFEQ
		HEATING ELEMENT 750W - 230V 483X64X21 mm
	OVEN:	C70-EFE, C70-EFEQ
Código fabricante / Manufacturer Code		1890600

## MARENO

	Referencia Code	<b>19605</b> ORIGINAL
		RESISTENCIA 2500W - 230V ØINT: 178 mm - ØEXT: 190 mm 242X35 mm
	HORNO	
		HEATING ELEMENT 2500W - 230V INNØ: 178 mm - EXTØ: 190 mm 242X35 mm
	OVEN	
Código fabricante / Manufacturer Code		10.37300200, 4330700,

## MARENO

	Referencia Code	<b>19886</b> ORIGINAL
		RESISTENCIA 1000W - 230V 557X132 mm
	HORNO:	DEBAJO COCINA
		HEATING ELEMENT 1000W - 230V 557X132 mm
	OVEN:	LOWER RANGE
Código fabricante / Manufacturer Code		213443

## MARENO

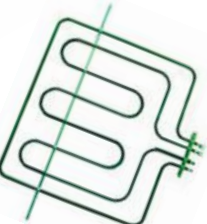
	Referencia Code	<b>19883</b> ORIGINAL
		RESISTENCIA 2600W - 230/400V 355X360 mm
	HORNO:	FOE-60M
		HEATING ELEMENT 2600W - 230/400V 355X360 mm
	OVEN:	FOE-60M
Código fabricante / Manufacturer Code		10.37302300

## MARENO

	Referencia Code	<b>19887</b> ORIGINAL
		RESISTENCIA 1000W - 230V 555X63 mm
	HORNO:	SERIE 700, SERIE 900, PROTAGONISTA
		HEATING ELEMENT 1000W - 230V 555X63 mm
	OVEN:	SERIES 700, SERIES 900, PROTAGONISTA
Código fabricante / Manufacturer Code		CM018102

## MARENO

	Referencia Code	<b>22247</b> ORIGINAL
		RESISTENCIA 6000W - 230V 338X37X50 mm
	HORNO	
		HEATING ELEMENT 6000W - 230/400V 338X37X50 mm
	OVEN	
Código fabricante / Manufacturer Code		10.37305500

\*CÓDIGO JUNTA / GASKET CODE  
90808

# RESISTENCIAS HORNO / OVEN HEATING ELEMENTS

## MBM



Referencia Code **22167** ORIGINAL

RESISTENCIA  
1500W - 230V  
350X510 mm

**HORNO:** MINIMA, E6F6, G6SFE6

• • •

HEATING ELEMENT  
1500W - 230V  
350X510 mm

**OVEN:** MINIMA, E6F6, G6SFE6

Código fabricante / Manufacturer Code **RIC0002548**



Referencia Code **22174** ORIGINAL

RESISTENCIA  
1500W - 230V  
360X110 mm

**HORNO:** FEPO50, FEM67, FEM69

• • •

HEATING ELEMENT  
1500W - 230V  
360X110 mm

**OVEN:** FEPO50, FEM67, FEM69

Código fabricante / Manufacturer Code **RTFOC00628**



Referencia Code **19605** ORIGINAL

RESISTENCIA  
2500W - 230V  
ØINT: 178 mm - ØEXT: 190 mm  
242X35 mm

**HORNO:** E4F6

• • •

HEATING ELEMENT  
2500W - 230V  
INNØ: 178 mm - EXTØ: 190 mm  
242X35 mm

**OVEN:** E4F6

Código fabricante / Manufacturer Code **RIC0001835**



Referencia Code **22171** ORIGINAL

RESISTENCIA  
2500W - 230V  
530X615 mm

**HORNO:** E4F, MAGISTRA

• • •

HEATING ELEMENT  
2500W - 230V  
530X615 mm

**OVEN:** E4F, MAGISTRA

Código fabricante / Manufacturer Code **RTCU900186**

## MBM



Referencia Code **22175** ORIGINAL

RESISTENCIA  
2500W - 230V  
600X125 mm

**HORNO:** FCE10, FEPO80, FEMD109, FEMD107SC, FEM109, FEM107SC, FEMD107, FEM107, FEC100, FEM100, FEM101, FEM102

• • •

HEATING ELEMENT  
2500W - 230V  
600X125 mm

**OVEN:** FCE10, FEPO80, FEMD109, FEMD107SC, FEM109, FEM107SC, FEMD107, FEM107, FEC100, FEM100, FEM101, FEM102

Código fabricante / Manufacturer Code **RTFOC00068**



Referencia Code **22176** ORIGINAL

RESISTENCIA  
2500W - 230V  
ØINT: 180 mm - ØEXT: 195 mm  
210X36 mm

**HORNO:** FEC023, FEMD023

• • •

HEATING ELEMENT  
2500W - 230V  
INNØ: 180 mm - EXTØ: 195 mm  
210X36 mm

**OVEN:** FEC023, FEMD023

Código fabricante / Manufacturer Code **RTCU700451**



Referencia Code **22168** ORIGINAL

RESISTENCIA  
2600W - 230V  
ØINT: 177 mm - ØEXT: 194 mm  
212X28 mm

**HORNO:** OMNIA, EFE07V

• • •

HEATING ELEMENT  
2600W - 230V  
INNØ: 177 mm EXTØ: 194 mm  
212X28 mm

**OVEN:** OMNIA, EFE07V

Código fabricante / Manufacturer Code **RTCU700650**



Referencia Code **22170** ORIGINAL

RESISTENCIA  
3200W - 230V  
510X526 mm

**HORNO:** OMNIA, EFE07

• • •

HEATING ELEMENT  
3200W - 230V  
510X526 mm

**OVEN:** OMNIA, EFE07

Código fabricante / Manufacturer Code **RTCU700281**

# RESISTENCIAS HORNO / OVEN HEATING ELEMENTS

## MBM

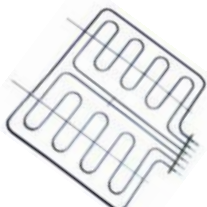
	Referencia Code <b>22169</b> ORIGINAL
	<p>RESISTENCIA 3950W - 230V 510X548 mm</p> <p><b>HORNO:</b> OMNIA, EF07</p> <p>• • •</p> <p>HEATING ELEMENT 3950W - 230V 510X548 mm</p> <p><b>OVEN:</b> OMNIA, EF07, E6</p>

Código fabricante / Manufacturer Code **RTCU700282**

	Referencia Code <b>22177</b> ORIGINAL
	<p>RESISTENCIA 6000W - 230V 297X37X50 mm</p> <p><b>HORNO:</b> FEM69, FEM67, FEM67SC, FEM109, FEM107, FEM110, FEM107SC</p> <p>• • •</p> <p>HEATING ELEMENT 6000W - 230V 297X37X50 mm</p> <p><b>OVEN:</b> FEM69, FEM67, FEM67SC, FEM109, FEM107, FEM110, FEM107SC</p>

Código fabricante / Manufacturer Code **RTFOC00523**

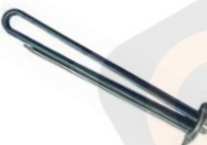
	Referencia Code <b>22247</b> ORIGINAL
	<p>RESISTENCIA 6000W - 230V 338X37X50 mm</p> <p><b>HORNO</b></p> <p>• • •</p> <p>HEATING ELEMENT 6000W - 230V 338X37X50 mm</p> <p><b>OVEN</b></p>

Código fabricante / Manufacturer Code **RTCU700619**

	Referencia Code <b>22172</b> ORIGINAL
	<p>RESISTENCIA 7500W - 230V ØINT: 250 mm - ØEXT: 265 mm 282X85 mm</p> <p><b>HORNO:</b> FCE6, FEMD69, FEMD67SC, FEMD67</p> <p>• • •</p> <p>HEATING ELEMENT 7500W - 230V INNØ: 250 mm - EXTØ: 265 mm 282X85 mm</p> <p><b>OVEN:</b> FCE6, FEMD69, FEMD67SC, FEMD67</p>

Código fabricante / Manufacturer Code **RTFOC00433**

## MBM

	Referencia Code <b>22178</b> ORIGINAL
	<p>RESISTENCIA 7500W - 230V 295X34X45 mm</p> <p><b>HORNO:</b> FEM207SC, FEM209, FEM610L, FEM060, FEM061, FEM100, FEM101, FMM060, FMM061, FMM100, FMM101, FEM062, FEM102, FEM200, FEM201, FEM202</p> <p>• • •</p> <p>HEATING ELEMENT 7500W - 230V 295X34X45 mm</p>

Código fabricante / Manufacturer Code **RTFOC00150**

	Referencia Code <b>22173</b> ORIGINAL
	<p>RESISTENCIA 21600W - 230V ØINT: 398 mm - ØEXT: 415 mm 465X148 mm</p> <p><b>HORNO:</b> FEP160, FEMD209, FEMD207SC, FEM209, FEM207SC, FEC200, FEMD200, FEM201, FEM200, FEM202</p> <p>• • •</p> <p>HEATING ELEMENT 21600W - 230V INNØ: 398 mm - EXTØ: 415 mm 465X148 mm</p> <p><b>OVEN:</b> FEP160, FEMD209, FEMD207SC, FEM209, FEM207SC, FEC200, FEMD200, FEM201, FEM200, FEM202</p>

Código fabricante / Manufacturer Code **RTFOC00307**

## MODULAR

	Referencia Code <b>20115</b> ORIGINAL
	<p>RESISTENCIA 1260W - 230V Ø180X380X19 mm</p> <p><b>HORNO:</b> 70/70CFGE, 70/110CFGE, 90/80CFGE, 90/120CFGE, 90/160CFGE, 90/80CFE, 90/120CFE, 90/80CFVE</p> <p>• • •</p> <p>HEATING ELEMENT 1260W - 230V Ø180X380X19 mm</p> <p><b>OVEN:</b> 70/70CFGE, 70/110CFGE, 90/80CFGE, 90/120CFGE, 90/160CFGE, 90/80CFE, 90/120CFE, 90/80CFVE</p>

Código fabricante / Manufacturer Code **665.008.00**

# RESISTENCIAS HORNO / OVEN HEATING ELEMENTS

## MODULAR



Referencia Code **20114** ORIGINAL

RESISTENCIA  
1400W - 230V  
305X180 mm

HORNO: 60-60CFGE, 60-60CFG, 60-60CFE

HEATING ELEMENT  
1400W - 230V  
305X180 mm

OVEN: 60-60CFGE, 60-60CFG, 60-60CFE

Código fabricante / Manufacturer Code **665.062.00**



Referencia Code **20113** ORIGINAL

RESISTENCIA  
2300W - 230V  
ØINT: 183mm - ØEXT: 197 mm  
212X30 mm

HORNO: 60-60CFGE, 60-60CFG, 60-60CFE

HEATING ELEMENT  
1400W - 230V  
INNØ: 183 mm - EXTØ: 197 mm  
212X30 mm

OVEN: 60-60CFGE, 60-60CFG, 60-60CFE

Código fabricante / Manufacturer Code **665.061.00**



Referencia Code **22247** ORIGINAL

RESISTENCIA  
6000W - 230V  
338X37X50 mm

HORNO

HEATING ELEMENT  
6000W - 230V  
338X37X50 mm

OVEN

\*CÓDIGO JUNTA / GASKET CODE  
90808

Código fabricante / Manufacturer Code **---**

## MOVILFRIT

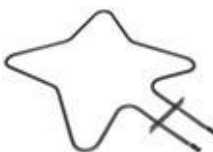

Referencia Code **48306** ORIGINAL

RESISTENCIA  
3000W - 230V

HORNO

HEATING ELEMENT  
3000W - 230V

OVEN

Código fabricante / Manufacturer Code **922543**

## OEM



Referencia Code **34546** ORIGINAL

RESISTENCIA  
600W - 230V  
575X127 mm / ROSCA 1/4"

HORNO: MF-8

HEATING ELEMENT  
600W - 230V  
575X127 mm / 1/4" THREAD

OVEN: MF-8

\*CÓDIGO JUNTA / GASKET CODE  
12481

Código fabricante / Manufacturer Code **EE13300**



Referencia Code **50470** ORIGINAL

RESISTENCIA  
600W - 400V  
575X131 mm / ROSCA 1/4"

HORNO: MF4S, MF8S

HEATING ELEMENT  
600W - 400V  
575X131 mm / 1/4" THREAD

OVEN: MF4S, MF8S

Código fabricante / Manufacturer Code **EE13500**



Referencia Code **50469** ORIGINAL

RESISTENCIA  
700W - 230V  
580X122 mm / ROSCA 1/4"

HORNO: MF8

HEATING ELEMENT  
700W - 230V  
580X122 mm / 1/4" THREAD

OVEN: MF8

Código fabricante / Manufacturer Code **EE13200**



Referencia Code **50471** ORIGINAL

RESISTENCIA  
700W - 400V  
575X120 mm / ROSCA 1/4"

HORNO: MF4, MF8

HEATING ELEMENT  
700W - 400V  
575X120 mm / 1/4" THREAD

OVEN: MF4, MF8

Código fabricante / Manufacturer Code **EE13400**

# RESISTENCIAS HORNO / OVEN HEATING ELEMENTS

## OEM

	Referencia Code	<b>26976</b> ORIGINAL
		RESISTENCIA 900W - 230V 875X125 mm / ROSCA 3/8"
	HORNO:	23 MECÁNICO-ELECTRÓNICO • • •
		HEATING ELEMENT 900W - 230V 875X122 mm / 3/8" THREAD
	OVEN:	23 ELECTRONIC.-MECHANIC

Código fabricante / Manufacturer Code **EE10900**

	Referencia Code	<b>50465</b> ORIGINAL
		RESISTENCIA 900W - 400V 580X160 mm / ROSCA 3/8"
	HORNO:	32 • • •
		HEATING ELEMENT 900W - 400V 580X160 mm / 3/8" THREAD
	OVEN:	32

Código fabricante / Manufacturer Code **EE10700**

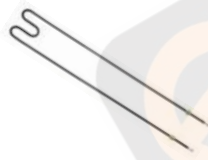
	Referencia Code	<b>50467</b> ORIGINAL
		RESISTENCIA 900W - 400V 979X120 mm / ROSCA 3/8"
	HORNO:	23 • • •
		HEATING ELEMENT 900W - 400V 979X120 mm / 3/8" THREAD
	OVEN:	23

Código fabricante / Manufacturer Code **EE11100**

	Referencia Code	<b>50473</b> ORIGINAL
		RESISTENCIA 900W - 230V 583X167 mm / ROSCA 3/8"
	HORNO:	23 MECÁNICO-ELECTRÓNICO • • •
		HEATING ELEMENT 900W - 230V 583X167 mm / 3/8" THREAD
	OVEN:	23 ELECTRONIC-MECHANIC

Código fabricante / Manufacturer Code **EE10500**

## OEM

	Referencia Code	<b>50481</b> ORIGINAL
		RESISTENCIA 1000W - 230V 473X275 mm / ROSCA 1/4"
	HORNO:	MF1 • • •
		HEATING ELEMENT 1000W - 230V 473X275 mm / 1/4" THREAD
	OVEN:	MF1

Código fabricante / Manufacturer Code **EE15700**

	Referencia Code	<b>26977</b> ORIGINAL
		RESISTENCIA 1100W - 230V 880X120 mm / ROSCA 3/8"
	HORNO:	23 MECÁNICO-ELECTRÓNICO • • •
		HEATING ELEMENT 1100W - 230V 880X120 mm / 3/8" THREAD
	OVEN:	23 ELECTRONIC.-MECHANIC

Código fabricante / Manufacturer Code **EE10800**

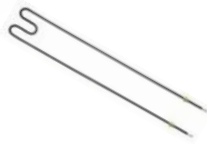
	Referencia Code	<b>50472</b> ORIGINAL
		RESISTENCIA 1100W - 400V 884X125 mm / ROSCA 3/8"
	HORNO:	23, MF5S, MF10S, SR69 • • •
		HEATING ELEMENT 1100W - 400V 884X125 mm / 3/8" THREAD
	OVEN:	23, MF5S, MF10S, SR69

Código fabricante / Manufacturer Code **EE11000**

	Referencia Code	<b>50474</b> ORIGINAL
		RESISTENCIA 1100W - 230V 580X160 mm / ROSCA 3/8"
	HORNO:	32 MECÁNICO-ELECTRÓNICO • • •
		HEATING ELEMENT 1100W - 230V 580X160 mm / 3/8" THREAD
	OVEN:	32 ELECTRONIC-MECHANIC

Código fabricante / Manufacturer Code **EE10400**



# RESISTENCIAS HORNO / OVEN HEATING ELEMENTS

## OEM



**Referencia Code** **50475** ORIGINAL

RESISTENCIA  
1100W - 400V  
580X165 mm / ROSCA 3/8"

**HORNO:** 32, MF11S, SR96

• • •

HEATING ELEMENT  
1100W - 400V  
580X165 mm / 3/8" THREAD

**OVEN:** 32, MF11S, SR96

\*CÓDIGO JUNTA / GASKET CODE  
90812

Código fabricante / Manufacturer Code **EE10600**



**Referencia Code** **50476** ORIGINAL

RESISTENCIA  
1300W - 230V  
880X163 mm / ROSCA 3/8"

**HORNO:** 33

• • •

HEATING ELEMENT  
1300W - 230V  
880X163 mm / 3/8" THREAD

**OVEN:** 33

\*CÓDIGO JUNTA / GASKET CODE  
90812

Código fabricante / Manufacturer Code **EE11300**

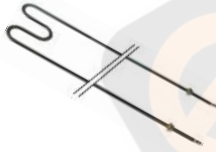

**Referencia Code** **50479** ORIGINAL

RESISTENCIA  
1300W - 400V  
880X160 mm / ROSCA 3/8"

**HORNO:** 33 MECÁNICO

• • •

HEATING ELEMENT  
1300W - 400V  
880X160 mm / 3/8" THREAD

**OVEN:** 33 MECHANICAL

\*CÓDIGO JUNTA / GASKET CODE  
90812

Código fabricante / Manufacturer Code **EE11500**



**Referencia Code** **50480** ORIGINAL

RESISTENCIA  
1600W - 400V  
880X155 mm / ROSCA 3/8"

**HORNO:** 33, MF15S, SR99

• • •

HEATING ELEMENT  
1600W - 400V  
880X155 mm / 3/8" THREAD

**OVEN:** 33, MF15S, SR99

Código fabricante / Manufacturer Code **EE11400**

## OEM



**Referencia Code** **50482** ORIGINAL

RESISTENCIA  
1650W - 230V  
470X450 mm / ROSCA 1/4"

**HORNO:** MF2

• • •

HEATING ELEMENT  
1650W - 230V  
470X450 mm / 1/4" THREAD

**OVEN:** MF2

\*CÓDIGO JUNTA / GASKET CODE  
1248

Código fabricante / Manufacturer Code **EE07000**



**Referencia Code** **50484** ORIGINAL

RESISTENCIA  
2000W - 230V  
600X572 mm / ROSCA 1/4"

**HORNO:** MF3

• • •

HEATING ELEMENT  
2000W - 230V  
600X572 mm / 1/4" THREAD

**OVEN:** MF3

\*CÓDIGO JUNTA / GASKET CODE  
1248

Código fabricante / Manufacturer Code **EE17700, EE23000**

## OLIS



**Referencia Code** **26652** ORIGINAL

RESISTENCIA  
1100W - 400V  
580X160 mm

**HORNO**

• • •

HEATING ELEMENT  
1100W - 400V  
580X160 mm

**OVEN**

Código fabricante / Manufacturer Code **---**

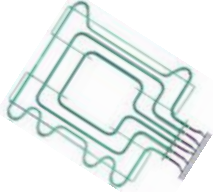

**Referencia Code** **20201** ORIGINAL

RESISTENCIA  
1800W - 230V  
515X452 mm

**HORNO:** SERIE 700

• • •

HEATING ELEMENT  
1800W - 230V  
515X452 mm

**OVEN:** SERIES 700

Código fabricante / Manufacturer Code **A037300**

# RESISTENCIAS HORNO / OVEN HEATING ELEMENTS

## OLIS

	Referencia Code	<b>20202</b> ORIGINAL
		RESISTENCIA 2750W - 230V 515X580 mm
	HORNO:	SERIE 900 •••
		HEATING ELEMENT 2750W - 230V 515X580 mm
	OVEN:	SERIES 900
Código fabricante / Manufacturer Code		<b>A037400</b>

	Referencia Code	<b>4548</b> ORIGINAL
		RESISTENCIA 7500W - 230V 510X40X49 mm
	HORNO:	•••
		HEATING ELEMENT 7500W - 230V 510X40X49 mm
	OVEN:	
Código fabricante / Manufacturer Code		<b>6A037202</b>

\*CÓDIGO JUNTA / GASKET CODE  
90808

## PIZZA GROUP

	Referencia Code	<b>84885</b> ORIGINAL
		RESISTENCIA 2000W - 380V 467X433 mm / ROSCA 1/4"
	HORNO:	F2/50 •••
		HEATING ELEMENT 2000W - 380V 467X433 mm / 1/4" THREAD
	OVEN:	F2/50
Código fabricante / Manufacturer Code		<b>5591300</b>

## RATIONAL

	Referencia Code	<b>23979</b> ORIGINAL
		RESISTENCIA 2000W - 230V 95X520 mm
	HORNO:	CD101, CD201, CM101, CM201 •••
		HEATING ELEMENT 2000W - 230V 95X520 mm
	OVEN:	CD101, CD201, CM101, CM201
Código fabricante / Manufacturer Code		<b>30041411</b>

## RATIONAL

	Referencia Code	<b>23980</b> ORIGINAL
		RESISTENCIA 2000W - 400V 85X530 mm
	HORNO:	101, 201 •••
		HEATING ELEMENT 2000W - 400V 85X530 mm
	OVEN:	101, 201
Código fabricante / Manufacturer Code		<b>30044300</b>

	Referencia Code	<b>23981</b> ORIGINAL
		RESISTENCIA 2500W - 230V 148X534 mm
	HORNO:	CD20, CM20 •••
		HEATING ELEMENT 2500W - 230V 148X534 mm
	OVEN:	CD20, CM20
Código fabricante / Manufacturer Code		<b>30041004</b>

	Referencia Code	<b>23982</b> ORIGINAL
		RESISTENCIA 2500W - 400V 140X510 mm
	HORNO:	•••
		HEATING ELEMENT 2500W - 400V 140X510 mm
	OVEN:	
Código fabricante / Manufacturer Code		<b>30044301</b>

	Referencia Code	<b>23966</b> ORIGINAL
		RESISTENCIA 3000W - 230V 380X60 mm / M14X1.5
	HORNO:	CC6, CD6, CD20, CM6, CM20 •••
		HEATING ELEMENT 3000W - 230V 380X60 mm / M14X1.5
	OVEN:	CC6, CD6, CD20, CM6, CM20
Código fabricante / Manufacturer Code		<b>30044146, 30043506 30044113, 30044306</b>

# RESISTENCIAS HORNO / OVEN HEATING ELEMENTS

## RATIONAL

Referencia Code **23968** ORIGINAL

RESISTENCIA  
3000W - 400V  
365X64 mm

HORNO: CC20, CM20

HEATING ELEMENT  
3000W - 400V  
365X64 mm

OVEN: CC20, CM20



Código fabricante / Manufacturer Code **30044303, 30043509**

Referencia Code **23965** ORIGINAL

RESISTENCIA  
6000W - 230V  
365X65 mm

HORNO: CC6, CD6, CD20, CD101,  
CD201, CM6, CM02, CM101, CM201

HEATING ELEMENT  
6000W - 230V  
365X65 mm

OVEN: CC6, CD6, CD20, CD101, CD201,  
CM6, CM02, CM101, CM201



Código fabricante / Manufacturer Code **30043505, 30044112  
30044136, 30044305**

Referencia Code **23967** ORIGINAL

RESISTENCIA  
6000W - 400V  
365X65 mm

HORNO: CC20, CC101, CC201, CM20,  
CM101, CM201

HEATING ELEMENT  
6000W - 400V  
365X65 mm

OVEN: CC20, CC101, CC201, CM20,  
CM101, CM201



Código fabricante / Manufacturer Code **30043508, 30044302**

Referencia Code **23969** ORIGINAL

RESISTENCIA  
6000W - 230V  
375X65 mm

HORNO: CC6, CD6, CD20, CD101,  
CD201, CM6

HEATING ELEMENT  
6000W - 230V  
375X65 mm

OVEN: CC6, CD6, CD20, CD101, CD201,  
CM63



Código fabricante / Manufacturer Code **30044155, 30044156  
30044162, 30044163**

## RATIONAL

Referencia Code **23970** ORIGINAL

RESISTENCIA  
6000W - 400V  
375X65 mm

HORNO: CC20, CC101, CC201, CM20,  
CCM101, CM201

HEATING ELEMENT  
6000W - 400V  
375X65 mm

OVEN: CC20, CC101, CC201, CM20,  
CCM101, CM2401



Código fabricante / Manufacturer Code **30044157, 30044158  
30044164, 30044165**

Referencia Code **23971** ORIGINAL

RESISTENCIA  
CON SONDA  
6000W - 230V  
355X65 mm

HORNO: CC6, CD6, CD20, CD101,  
CD201, CM6, CM20, CM101, CM201

WITH PROBE  
HEATING ELEMENT  
6000W - 230V  
355X65 mm

OVEN: CC6, CD6, CD20, CD101, CD201,  
CM6, CM20, CM101, CM201



Código fabricante / Manufacturer Code **30043516, 30044105, 30044108  
30044114, 30044121, 30044307**

Referencia Code **23972** ORIGINAL

RESISTENCIA  
CON SONDA  
6000W - 400V  
375X65 mm

HORNO: CC20, CC101, CC201, CM20,  
CM201

WITH PROBE  
HEATING ELEMENT  
6000W - 400V  
375X65 mm

OVEN: CC20, CC101, CC201, CM20,  
CM201



Código fabricante / Manufacturer Code **30043518, 30043522, 30044117  
30044120, 30044304**

# RESISTENCIAS HORNO / OVEN HEATING ELEMENTS

## RATIONAL



**Referencia Code** **23973** ORIGINAL

RESISTENCIA  
9000W - 230V  
205X38X70 mm

**HORNO:** CCC, CCD, CCM, CM, CPC, CD

HEATING ELEMENT  
9000W - 230V  
208X38X70 mm

**OVEN:** CCC, CCD, CCM, CM, CPC, CD

\*CÓDIGO JUNTA / GASKET CODE  
23912

**Código fabricante / Manufacturer Code** 32001200, 32011000, 32011004,  
32011009, 87201590



**Referencia Code** **23974** ORIGINAL

RESISTENCIA  
9000W - 230V  
232X76X38 mm

**HORNO:** CCC61, CCC101, CCD61, CCD101, CCD102, CCM61, CCM102

HEATING ELEMENT  
9000W - 230V  
232X76X38 mm

**OVEN:** CCC61, CCC101, CCD61, CCD101, CCD102, CCM61, CCM102

\*CÓDIGO JUNTA / GASKET CODE  
23976

**Código fabricante / Manufacturer Code** 32011200, 32011206



**Referencia Code** **23978** ORIGINAL

RESISTENCIA  
9000W - 230V  
ØINT: 310 mm - ØEXT: 333 mm  
410X115 mm

**HORNO:** CC6, CD6, CM6

HEATING ELEMENT  
9000W - 230V  
INNØ: 310 mm - EXTØ: 333 mm  
410X115 mm

**OVEN:** CC6, CD6, CM6

**Código fabricante / Manufacturer Code** 30043507, 30043515, 30043524  
30044326, 30353524



**Referencia Code** **23983** ORIGINAL

RESISTENCIA  
9000W - 230V  
ØINT: 385 mm - ØEXT: 400 mm  
420X125 mm

**HORNO:** CD101, CD201

HEATING ELEMENT  
9000W - 230V  
INNØ: 385 mm - EXTØ: 400 mm  
420X125 mm

**OVEN:** CD101, CD201

**Código fabricante / Manufacturer Code** 30043529

## RATIONAL



**Referencia Code** **23984** ORIGINAL

RESISTENCIA  
9000W - 230V  
ØINT: 440 mm - ØEXT: 453 mm  
470X140 mm

**HORNO:** CD101, CD201

HEATING ELEMENT  
9000W - 230V  
INNØ: 440 mm - EXTØ: 453 mm  
470X140 mm

**OVEN:** CD101, CD201

**Código fabricante / Manufacturer Code** 30043528



**Referencia Code** **23985** ORIGINAL

RESISTENCIA  
9000W - 400V  
ØINT: 385 mm - ØEXT: 400 mm  
402X112 mm

**HORNO:** CC101, CC201, CM101, CM201

HEATING ELEMENT  
9000W - 230V  
INNØ: 358 mm - EXTØ: 400 mm  
402X112 mm

**OVEN:** CC101, CC201, CM101, CM201

**Código fabricante / Manufacturer Code** 30043531



**Referencia Code** **23986** ORIGINAL

RESISTENCIA  
9000W - 400V  
ØINT: 440 mm - ØEXT: 453 mm  
465X140 mm

**HORNO:** CC101, CC201, CM101, CM201

HEATING ELEMENT  
9000W - 400V  
INNØ: 440 mm - EXTØ: 453 mm  
465X140 mm

**OVEN:** CC101, CC201, CM101, CM201

**Código fabricante / Manufacturer Code** 30043530



**Referencia Code** **23992** ORIGINAL

RESISTENCIA  
9000W - 400V  
ØINT: 445 mm - ØEXT: 458 mm  
474X130 mm

**HORNO:** CCC61, CCC101, CCC201-, CD61, CCD101, CCD201, CCM101, CCM201, CCM61, CM61, CPC61, CPC101, CPC201, CM201N, CM101N

HEATING ELEMENT  
9000W - 400V  
INNØ: 445 mm - EXTØ: 458 mm  
474X130 mm

**OVEN:** CCC61, CCC101, CCC201-, CD61, CCD101, CCD201, CCM101, CCM201, CCM61, CM61, CPC61, CPC101, CPC201, CM201N, CM101N

**Código fabricante / Manufacturer Code** 32001000

# RESISTENCIAS HORNO / OVEN HEATING ELEMENTS

## RATIONAL

	Referencia Code	<b>23993</b> ORIGINAL
	RESISTENCIA 9000W - 230V ØINT: 504 mm - ØEXT: 516 mm 535X130 mm	
	<b>HORNO:</b> CCC101, CCC201, CCD101, CCD201, CCM101, CCM201, CPC101, CM101N, CM201N, CPC201	
	HEATING ELEMENT 9000W - 230V INNØ: 504 mm - EXTØ: 516 mm 535X130 mm	
<b>OVEN:</b> CCC101, CCC201, CCD101, CCD201, CCM101, CCM201, CPC101, CM101N, CM201N, CPC201		
Código fabricante / Manufacturer Code <b>32001001, 32001009, 87201595</b>		

	Referencia Code	<b>23994</b> ORIGINAL
	RESISTENCIA 15000W - 230V ØINT: 505 mm - ØEXT: 520 mm 615X180 mm	
	<b>HORNO:</b> CCC102, CCC202, CCD102, CCD202, CCM102, CCM202, CPC202, CPC102, CM102N	
	HEATING ELEMENT 15000W - 230V INNØ: 505 mm - EXTØ: 520 mm 615X180 mm	
<b>OVEN:</b> CCC102, CCC202, CCD102, CCD202, CCM102, CCM202, CPC202, CPC102, CM102N		
Código fabricante / Manufacturer Code <b>32001002, 32001013</b>		

	Referencia Code	<b>23995</b> ORIGINAL
	RESISTENCIA 15000W - 230V ØINT: 635 mm - ØEXT: 650 mm 696X200 mm	
	<b>HORNO:</b> CCC102, CCC202, CCD102, CCD202, CCM102, CCM202, CPC202, CM102N, CM202N, CPC102	
	HEATING ELEMENT 15000W - 230V INNØ: 635 mm - EXTØ: 650 mm 696X200 mm	
<b>OVEN:</b> CCC102, CCC202, CCD102, CCD202, CCM102, CCM202, CPC202, CM102N, CM202N, CPC102		
Código fabricante / Manufacturer Code <b>32001003, 32001017</b>		

	Referencia Code	<b>23987</b> ORIGINAL
	RESISTENCIA 18000W - 400V ØINT: 385 mm - ØEXT: 440 mm 460X140 mm	
	<b>HORNO:</b> CD, CM101, CM201-4, CM91-5, CM97	
	HEATING ELEMENT 15000W - 230V INNØ: 635 mm - EXTØ: 650 mm 696X200 mm	
<b>OVEN:</b> CD, CM101, CM201-4, CM91-5, CM97		
Código fabricante / Manufacturer Code <b>30043519</b>		

## RATIONAL

	Referencia Code	<b>90160</b> ORIGINAL
	RESISTENCIA 18000W - 230V 194X87X68 mm	
	<b>HORNO:</b> CM62E, CM102E, CM201E, CM202E, SCC62E, SCC102E, SCC201E, SCC202E	
	HEATING ELEMENT 18000W - 230V 194X87X68 mm	
<b>OVEN:</b> CM62E, CM102E, CM201E, CM202E, SCC62E, SCC102E, SCC201E, SCC202E		
Código fabricante / Manufacturer Code <b>4400195, 8700367</b>		

<b>REPAGAS</b>		
	Referencia Code	<b>22227</b> ORIGINAL
	RESISTENCIA 3000W - 230V 220X65 mm	
	<b>HORNO</b>	
	HEATING ELEMENT 3000W - 230V 220X65 mm	
<b>OVEN</b>		
Código fabricante / Manufacturer Code <b>42000003</b>		

	Referencia Code	<b>22182</b> ORIGINAL
	RESISTENCIA 3300W - 230V ØINT: 185 mm - ØEXT: 200 mm 215X30 mm	
	<b>HORNO</b>	
	HEATING ELEMENT 2750W - 230V INNØ: 185 mm - EXTØ: 200 mm 215X30 mm	
<b>OVEN</b>		
Código fabricante / Manufacturer Code <b>1230005</b>		

	Referencia Code	<b>22225</b> ORIGINAL
	RESISTENCIA 3500W - 230V 620X120X33 mm	
	<b>HORNO</b>	
	HEATING ELEMENT 3500W - 230V 620X120X33 mm	
<b>OVEN</b>		
Código fabricante / Manufacturer Code <b>1240014</b>		

# RESISTENCIAS HORNO / OVEN HEATING ELEMENTS

## REPAGAS



Referencia Code **22221** ORIGINAL

RESISTENCIA  
8000W - 230V  
ØINT: 250 mm - ØEXT: 265 mm  
277X75 mm

HORNO  
• • •

HEATING ELEMENT  
8000W - 230V  
INNØ: 250 mm - EXTØ: 265 mm  
277X75 mm

OVEN

Código fabricante / Manufacturer Code **1250016**



Referencia Code **80257** ORIGINAL

RESISTENCIA  
8000W - 230V  
ØINT: 287 mm - ØEXT: 300 mm  
345X90 mm

HORNO  
• • •

HEATING ELEMENT  
8000W - 230V  
INNØ: 287 mm - EXTØ: 300 mm  
345X90 mm

OVEN

Código fabricante / Manufacturer Code **1250016**

## ROLLER GRILL

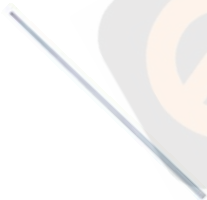

Referencia Code **47508** ORIGINAL

TUBO CUARZO RESISTENCIA  
690XØ11 mm

HORNO: PZ660  
• • •

QUARTZ HEATING ELEMENT TUBE  
690XØ11 mm

OVEN: PZ660

Código fabricante / Manufacturer Code **D04013**



Referencia Code **84604** ORIGINAL

RESISTENCIA CUARZO  
250W - 230V  
320XØ4.5 mm

HORNO: PZ660  
• • •

QUARTZ HEATING ELEMENT  
250W - 230V  
320XØ4.5 mm

OVEN: PZ660

Código fabricante / Manufacturer Code **D01026**

## SALVA



Referencia Code **33998** STANDARD

RESISTENCIA  
1000W - 230V  
530X200 mm

HORNO  
• • •

HEATING ELEMENT  
1000W - 230V  
530X200 mm

OVEN



Referencia Code **34000** STANDARD

RESISTENCIA  
1200W - 230V  
435X210 mm

HORNO  
• • •

HEATING ELEMENT  
1200W - 230V  
435X210 mm

OVEN



Referencia Code **34001** STANDARD

RESISTENCIA  
2000W - 230V  
445X150 mm

HORNO  
• • •

HEATING ELEMENT  
2000W - 230V  
445X150 mm

OVEN

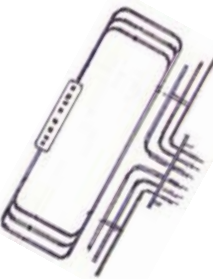

Referencia Code **33997** STANDARD

RESISTENCIA  
5400W - 230V  
548X260 mm

HORNO  
• • •

HEATING ELEMENT  
5400W - 230V  
548X260 mm

OVEN

# RESISTENCIAS HORNO / OVEN HEATING ELEMENTS

## SALVA

	Referencia Code	<b>34002</b> STANDARD
		RESISTENCIA 6000W - 230V 405X50 mm
	HORNO	..... HEATING ELEMENT 6000W - 230V 405X50 mm
	OVEN	

## SILANOS

	Referencia Code	<b>24759</b> ORIGINAL
		RESISTENCIA 2500W - 230V
	HORNO	..... HEATING ELEMENT 2500W - 230V
	OVEN	

## SCHOLTER

	Referencia Code	<b>86073</b> STANDARD
		RESISTENCIA 2750W - 230V ØINT: 215 mm 255X24 mm
	HORNO	..... HEATING ELEMENT 2750W - 230V INNØ: 215 mm 255X24 mm
	OVEN	

Código fabricante / Manufacturer Code **EKRE019510170**

Referencia Code **50423** ORIGINAL

		RESISTENCIA 3700W - 230V Ø250 mm
	HORNO: 643	..... HEATING ELEMENT 3700W - 230V Ø250 mm
	OVEN: 643	
	Código fabricante / Manufacturer Code	<b>FMRE200001126</b>

## SILANOS

	Referencia Code	<b>23769</b> ORIGINAL
		RESISTENCIA 2000W - 230V 370X210 mm
	HORNO	..... HEATING ELEMENT 2000W - 230V 370X210 mm
	OVEN	

Código fabricante / Manufacturer Code

Referencia Code **22247** ORIGINAL

		RESISTENCIA 6000W - 230V 338X37X50 mm
	HORNO	..... HEATING ELEMENT 6000W - 230V 338X37X50 mm
	OVEN	
	Código fabricante / Manufacturer Code	<b>905570, 905571</b>

\*CÓDIGO JUNTA / GASKET CODE  
90808

Referencia Code **90599** ORIGINAL

		RESISTENCIA 2000W - 230V Ø190 mm
	HORNO	..... HEATING ELEMENT 2000W - 230V Ø190 mm
	OVEN	
	Código fabricante / Manufacturer Code	<b>EKRE9952477000</b>

## SILKO

	Referencia Code	<b>22180</b> ORIGINAL
		RESISTENCIA 900W - 230V 468X112X23 mm
	HORNO	..... HEATING ELEMENT 900W - 230V 468X112X23 mm
	OVEN	
Código fabricante / Manufacturer Code	<b>0101554</b>	

# RESISTENCIAS HORNO / OVEN HEATING ELEMENTS

## SILKO



\*CÓDIGO JUNTA / GASKET CODE  
90808

Referencia  
Code **22247** ORIGINAL

RESISTENCIA  
6000W - 230V  
338X37X50 mm

HORNO

• • •

HEATING ELEMENT  
6000W - 230V  
338X37X50 mm

OVEN

Código fabricante / Manufacturer Code ---

## SMEG



Referencia  
Code **90106** ORIGINAL

RESISTENCIA  
1770W - 230V  
ØINT: 180 mm - ØEXT: 192  
212X34 mm

HORNO: ALFA135X

• • •

HEATING ELEMENT  
1770W - 230V  
INNØ: 180 mm - EXTØ: 192 mm  
212X34 mm

OVEN: ALFA135X

Código fabricante / Manufacturer Code 806890378

Referencia  
Code **84656** ORIGINAL

RESISTENCIA  
2660W - 230V  
ØINT: 210 mm - ØEXT: 223 mm  
245X34 mm

HORNO: ALFA135BM, ALFA135GH,  
ALFA135VM, ALFA135XM, ALFA161X,  
ALFA161XK, RFT844, RFT844B, RFT844V

• • •

HEATING ELEMENT  
2660W - 230V  
INNØ: 210 mm - EXTØ: 223 mm  
245X34 mm

OVEN: ALFA135BM, ALFA135GH,  
ALFA135VM, ALFA135XM, ALFA161X,  
ALFA161XK, RFT844, RFT844B, RFT844V

Código fabricante / Manufacturer Code 806890550

Referencia  
Code **87639** ORIGINAL

RESISTENCIA  
2700W - 230V  
ØINT: 180 mm - ØEXT: 195 mm  
210X30 mm

HORNO: ALFA11-ALFA41-ALFA61

• • •

HEATING ELEMENT  
2700W - 230V  
INNØ: 180 mm - EXTØ: 195 mm  
210X30 mm

OVEN: ALFA11-ALFA41-ALFA61

Código fabricante / Manufacturer Code 806890656

## SMEG



Referencia  
Code **95604** ORIGINAL

RESISTENCIA  
3990W - 230V  
ØINT: 222 mm - ØEXT: 235 mm  
245X38 mm

HORNO: ALFA135BE, ALFA135V6,  
ALFA135VE, ALFA135XE, ALFA135XE,  
ALFA141VE, ALFA141XE, ALFA200X,  
ALFA200XE, ALFA200XM, ALFA201XE,  
ALFA201XM

• • •

HEATING ELEMENT  
3990W - 230V  
INNØ: 222 mm - EXTØ: 235 mm  
245X38 mm

OVEN: ALFA135BE, ALFA135V6,  
ALFA135VE, ALFA135XE, ALFA135XE,  
ALFA141VE, ALFA141XE, ALFA200X,  
ALFA200XE, ALFA200XM, ALFA201XE,  
ALFA201XM

Código fabricante / Manufacturer Code 806890437

## TECNOINOX



\*CÓDIGO JUNTA / GASKET CODE  
1248

Referencia  
Code **20166** ORIGINAL

RESISTENCIA  
1000W - 230V  
395X65X35 mm / ROSCA 1/4"

HORNO: PFE7, PFC70E

• • •

HEATING ELEMENT  
1000W - 230V  
395X65X35 mm / 1/4" THREAD

OVEN: PFE7, PFC70E

Código fabricante / Manufacturer Code 00775

Referencia  
Code **19605** ORIGINAL

RESISTENCIA  
2500W - 230V  
ØINT: 178 mm - ØEXT: 190 mm  
242X35 mm

HORNO

• • •

HEATING ELEMENT  
2500W - 230V  
INNØ: 178 mm - EXTØ: 190 mm  
242X35 mm

OVEN

Código fabricante / Manufacturer Code 00568





# RESISTENCIAS HORNO / OVEN HEATING ELEMENTS

## TEKA

	Referencia Code	<b>87156</b> STANDARD
	HORNO	RESISTENCIA 1500W - 230V 297X266X30 mm
	OVEN	HEATING ELEMENT 1500W - 230V 297X266X30 mm

	Referencia Code	<b>87157</b> STANDARD
	HORNO	RESISTENCIA 1500W - 230V 307X266X275X54 mm
	OVEN	HEATING ELEMENT 1500W - 230V 307X266X275X54 mm

	Referencia Code	<b>87201</b> STANDARD
	HORNO	RESISTENCIA 1600W + 1500W - 230V 320X302X54 mm
	OVEN	HEATING ELEMENT 1600W + 1500W - 230V 320X302X54 mm

	Referencia Code	<b>87206</b> STANDARD
	HORNO	RESISTENCIA 1600W - 230V 297X265 mm
	OVEN	HEATING ELEMENT 1600W - 230V 297X265 mm

## UNOX

	Referencia Code	<b>24702</b> ORIGINAL
	HORNO:	RESISTENCIA 1600W - 230V ØINT: 220 mm - ØEXT: 235 mm 265X50 mm
	OVEN:	HEATING ELEMENT 1600W - 230V INNØ: 220 mm - EXTØ: 235 mm 265X50 mm

Código fabricante / Manufacturer Code		<b>KRS011</b>
	Referencia Code	<b>26644</b> ORIGINAL
	HORNO:	RESISTENCIA 2650W - 230V ØEXT: 235 mm X115 mm
	OVEN:	HEATING ELEMENT 2650W - 230V EXTØ: 235 mm X115 mm

Código fabricante / Manufacturer Code		<b>KRS002</b>
	Referencia Code	<b>89344</b> ORIGINAL
	HORNO:	RESISTENCIA 2900W - 230V ØINT: 220 mm - ØEXT: 235 mm 268X40 mm
	OVEN:	HEATING ELEMENT 2900W - 230V INNØ: 220 mm - EXTØ: 235 mm 268X40 mm

Código fabricante / Manufacturer Code		<b>KRS1130A</b>
	Referencia Code	<b>24224</b> ORIGINAL
	HORNO:	RESISTENCIA 3100W - 230V ØINT: 220 mm - ØEXT: 235 mm 110x45 mm
	OVEN:	HEATING ELEMENT 3100W - 230V INNØ: 220 mm EXTØ: 235 mm 110X45 mm

Código fabricante / Manufacturer Code **KRS003, KRS1026, RS025, RS026**

# RESISTENCIAS HORNO / OVEN HEATING ELEMENTS

## UNOX

Referencia Code **24225** ORIGINAL



RESISTENCIA  
3100W - 230V  
ØEXT: 235X110 mm

HORNO: XF090-P

HEATING ELEMENT  
3100W - 230V  
EXTØ: 235X110 mm

OVEN: XF090-P

Código fabricante / Manufacturer Code ---

Referencia Code **50522** ORIGINAL



RESISTENCIA  
4250W - 230V  
ØINT: 220 mm - ØEXT: 235 mm  
265X50 mm

HORNO: XV301, XV301E

HEATING ELEMENT  
4250W - 230V  
INNØ: 220 mm - EXTØ: 235 mm  
265X50 mm

OVEN: XV301, XV301E

Código fabricante / Manufacturer Code KRS012

## ZANUSSI

Referencia Code **22255** ORIGINAL



RESISTENCIA  
950W - 230V  
550X63 mm

HORNO: HCF-GE, HCF-E (2ª Generación)

HEATING ELEMENT  
950W - 230V  
550X63 mm

OVEN: HCF-GE, HCF-E (2nd Generation)

Código fabricante / Manufacturer Code 59237

Referencia Code **22261** ORIGINAL



RESISTENCIA  
1000W - 230V  
335X345 mm

HORNO: FCF-E4, ACF-E4

HEATING ELEMENT  
1000W - 230V  
335X345 mm

OVEN: FCF-E4, ACF-E4

Código fabricante / Manufacturer Code 05218

## ZANUSSI

Referencia Code **22253** ORIGINAL



RESISTENCIA  
1500W - 230V  
540X150X15 mm / ROSCA M10

HORNO: SCFE700

HEATING ELEMENT  
1500W - 230V  
540X150X15 mm / M10 THREAD

OVEN: SCFE700

\*CÓDIGO JUNTA / GASKET CODE  
90813

Código fabricante / Manufacturer Code 54147

Referencia Code **22256** ORIGINAL



RESISTENCIA  
1500W - 230V  
530X148X24 mm

HORNO: NCFGE, NCFE, N700, N900

HEATING ELEMENT  
1500W - 230V  
530X148X24 mm

OVEN: NCFGE, NCE, N700, N900

Código fabricante / Manufacturer Code 0C0310

Referencia Code **22259** ORIGINAL



RESISTENCIA  
2000W - 230V  
314X290 mm

HORNO: FCF-E4

HEATING ELEMENT  
2000W - 230V  
314X290 mm

OVEN: FCF-E4

Código fabricante / Manufacturer Code 54326

Referencia Code **25080** ORIGINAL



RESISTENCIA  
2000W - 230V  
892X245 mm / ROSCA 1/4"

HORNO

HEATING ELEMENT  
2000W - 230V  
892X245 mm / 1/4" THREAD

OVEN

Código fabricante / Manufacturer Code 004202

# RESISTENCIAS HORNO / OVEN HEATING ELEMENTS

## ZANUSSI

	Referencia Code	<b>22260</b> ORIGINAL
	RESISTENCIA 2250W - 230V 333X347 mm	
	<b>HORNO:</b> FCF-E4 ● ● ● <b>HEATING ELEMENT</b> 2250W - 230V 333X347 mm  <b>OVEN:</b> FCF-E4	
Código fabricante / Manufacturer Code <b>05205</b>		

	Referencia Code	<b>16686</b> STANDARD
	RESISTENCIA 2500W - 230V Ø170 mm	
	<b>HORNO</b> ● ● ● <b>HEATING ELEMENT</b> 2500W - 230V Ø170 mm  <b>OVEN</b>	
Código fabricante / Manufacturer Code <b>05205</b>		

	Referencia Code	<b>19605</b> ORIGINAL
	RESISTENCIA 2500W - 230V ØINT: 176 mm - ØEXT: 188 mm 210X28 mm	
	<b>HORNO</b> ● ● ● <b>HEATING ELEMENT</b> 2500W - 230V INNØ: 176 mm - EXTØ: 188 mm 210X28 mm  <b>OVEN</b>	
Código fabricante / Manufacturer Code <b>004934</b>		

	Referencia Code	<b>22257</b> ORIGINAL
	RESISTENCIA 2500W - 230V ØINT: 175 mm ØEXT: 195 mm X245X55 mm	
	<b>HORNO:</b> FCF-E2 ● ● ● <b>HEATING ELEMENT</b> 2500W - 230V INNØ: 175 mm EXTØ: 195 mm 245X55 mm  <b>OVEN:</b> FCF-E2	
Código fabricante / Manufacturer Code <b>54843</b>		

## ZANUSSI

	Referencia Code	<b>22262</b> ORIGINAL
	RESISTENCIA 2500W - 230V 544X350 mm	
	<b>HORNO:</b> FCF-E6, ECF-E6, ZCF-E6, ACF-E6, NCF-E6, JCF-E6, RCF-061E ● ● ● <b>HEATING ELEMENT</b> 2500W - 230V 544X350 mm  <b>OVEN:</b> FCF-E6, ECF-E6, ZCF-E6, ACF-E6, NCF-E6, JCF-E6, RCF-061E	
Código fabricante / Manufacturer Code <b>58145</b>		

	Referencia Code	<b>22258</b> ORIGINAL
	RESISTENCIA 3000W - 230V ØINT: 179 mm - ØEXT: 190 mm 245X35 mm	
	<b>HORNO:</b> FCF-E4 ● ● ● <b>HEATING ELEMENT</b> 3000W - 230V INNØ: 179 mm - EXTØ: 190 mm 245X35 mm  <b>OVEN:</b> FCF-E4	
Código fabricante / Manufacturer Code <b>55503</b>		

	Referencia Code	<b>22278</b> ORIGINAL
	RESISTENCIA 3200W - 400V ØINT: 383 mm - ØEXT: 400mm 536X60 mm	
	<b>HORNO:</b> AOS061E, FCZ061E, EJN061E, RDR061E ● ● ● <b>HEATING ELEMENT</b> 3200W - 400V ØINNØ: 383 mm - EXTØ: 400mm 536X60 mm  <b>OVEN:</b> AOS061E, FCZ061E, EJN061E, RDR061E	
Código fabricante / Manufacturer Code <b>55503</b>		

	Referencia Code	<b>22271</b> ORIGINAL
	RESISTENCIA 3200W - 400V 535X348X34 mm	
	<b>HORNO:</b> FCV-E61, FCV-E63 ● ● ● <b>HEATING ELEMENT</b> 3200W - 400V 535X348X34 mm  <b>OVEN:</b> FCV-E61, FCV-E63	
Código fabricante / Manufacturer Code <b>056930</b>		

# RESISTENCIAS HORNO / OVEN HEATING ELEMENTS

## ZANUSSI

 <p>*CÓDIGO JUNTA / GASKET CODE 22273</p>	<b>Referencia Code</b> <b>22272</b> ORIGINAL
	RESISTENCIA 4500W - 230V 534X350X70 mm
	<b>HORNO:</b> FCV-E6 (HASTA 1999) . . . HEATING ELEMENT 4500W - 230V 534X350X70 mm
	<b>OVEN:</b> FCV-E6 (UNTIL 1999)
<b>Código fabricante / Manufacturer Code</b> <b>02757</b>	

 <p>*CÓDIGO JUNTA / GASKET CODE 22273</p>	<b>Referencia Code</b> <b>22274</b> ORIGINAL
	RESISTENCIA 5566W - 230V ØINT: 470 mm - ØEXT: 487 mm 590X66 mm
	<b>HORNO:</b> FCV-E10 . . . HEATING ELEMENT 5566W - 230V INNØ: 470 mm - EXTØ: 487 mm 590X66 mm
	<b>OVEN:</b> FCV-E10
<b>Código fabricante / Manufacturer Code</b> <b>54620</b>	

 <p>*CÓDIGO JUNTA / GASKET CODE 22273</p>	<b>Referencia Code</b> <b>22263</b> ORIGINAL
	RESISTENCIA 5666W - 230V ØINT: 470 mm - ØEXT: 487 mm 590X66 mm
	<b>HORNO:</b> FCF-E10 . . . HEATING ELEMENT 5666W - 230V INNØ: 470 mm - EXTØ: 487 mm 590X66 mm
	<b>OVEN:</b> FCF-E10
<b>Código fabricante / Manufacturer Code</b> <b>53839</b>	

 <p>*CÓDIGO JUNTA / GASKET CODE 22273</p>	<b>Referencia Code</b> <b>22275</b> ORIGINAL
	RESISTENCIA 5666W - 230V ØINT: 465 mm - ØEXT: 480 mm 580X65 mm
	<b>HORNO:</b> FCF-E101, FCF-E201, FCV-E10, FCV-E20 . . . HEATING ELEMENT 5666W - 230V INNØ: 470 mm - EXTØ: 487 mm 590X66 mm
	<b>OVEN:</b> FCF-E101, FCF-E201, FCV-E10, FCV-E20
<b>Código fabricante / Manufacturer Code</b> <b>002688</b>	

## ZANUSSI

 <p>*CÓDIGO JUNTA / GASKET CODE 22276</p>	<b>Referencia Code</b> <b>22279</b> ORIGINAL
	RESISTENCIA 5670W - 400V ØINT: 467 mm - ØEXT: 483 mm 855X60 mm
	<b>HORNO:</b> AOS101E, AOS201E, FCZ101E, FCZ201E, EJNI201E, RDR201E . . . HEATING ELEMENT 5670W - 400V INNØ: 467 mm EXTØ: 483 mm 855X60 mm
	<b>OVEN:</b> AOS101E, AOS201E, FCZ101E, FCZ201E, EJNI201E, RDR201E
<b>Código fabricante / Manufacturer Code</b> <b>007064</b>	

 <p>*CÓDIGO JUNTA / GASKET CODE 19257</p>	<b>Referencia Code</b> <b>22281</b> ORIGINAL
	RESISTENCIA 7500W - 230V 260X35X32 mm
	<b>HORNO:</b> FCV-E61 . . . HEATING ELEMENT 7500W - 400V 260X35X32 mm
	<b>OVEN:</b> FCV-E61
<b>Código fabricante / Manufacturer Code</b> <b>55463</b>	

 <p>*CÓDIGO JUNTA / GASKET CODE 19257</p>	<b>Referencia Code</b> <b>22282</b> ORIGINAL
	RESISTENCIA 7900W - 230V 287X33X35 mm
	<b>HORNO:</b> FCV-E61, FCV-E63, FCFM-E62, XFV-E700 . . . HEATING ELEMENT 7900W - 230V 287X33X35 mm
	<b>OVEN:</b> FCV-E61, FCV-E63, FCFM-E62, XFV-E700
<b>Código fabricante / Manufacturer Code</b> <b>55463</b>	

	<b>Referencia Code</b> <b>22264</b> ORIGINAL
	RESISTENCIA 8000W - 230V 170X505X128 mm
	<b>HORNO:</b> FCF-E40, FCF-E20, FCV-E20 . . . HEATING ELEMENT 8000W - 230V 170X505X128 mm
	<b>OVEN:</b> FCF-E40, FCF-E20, FCV-E20
<b>Código fabricante / Manufacturer Code</b> <b>54051</b>	

# RESISTENCIAS HORNO / OVEN HEATING ELEMENTS

## ZANUSSI

	Referencia Code	<b>22265</b> ORIGINAL
	RESISTENCIA 8000W - 400V 150X545X134 mm	
	<b>HORNO:</b> FCV-E202, FCV-E204, FCV-E20P •••	
	HEATING ELEMENT 8000W - 230V 150X545X134 mm	
<b>OVEN:</b> FCV-E202, FCV-E204, FCV-E20P		
Código fabricante / Manufacturer Code <b>56970</b>		

	Referencia Code	<b>22267</b> ORIGINAL
	RESISTENCIA 8000W - 400V ØINT: 560 mm - ØEXT: 580 mm 630X68 mm	
	<b>HORNO:</b> FCF-E102, FCF-E202 •••	
	HEATING ELEMENT 8000W - 400V INNØ: 560 mm - EXTØ: 580 mm 630X68 mm	
<b>OVEN:</b> FCF-E102, FCF-E202		
Código fabricante / Manufacturer Code <b>A5330</b>		

	Referencia Code	<b>22280</b> ORIGINAL
	RESISTENCIA 8000W - 400V ØINT: 569 mm - ØEXT: 580 mm 700X60 mm	
	<b>HORNO:</b> AOS202E, AOS102E, FCZ102E, FCZ202E, EJNI102E, EJNI202N •••	
	HEATING ELEMENT 8000W - 400V INNØ: 569 mm - EXTØ: 580 mm 700X60 mm	
<b>OVEN:</b> AOS202E, AOS102E, FCZ102E, FCZ202E, EJNI102E, EJNI202N		
Código fabricante / Manufacturer Code <b>0C1173</b>		

	Referencia Code	<b>22283</b> ORIGINAL
	RESISTENCIA 9000W - 230V 290X32X38 mm	
	<b>HORNO:</b> FCV-E6, ECV-E6, ZCV-E6, RCV-E6, FCS061E •••	
	HEATING ELEMENT 9000W - 230V 290X32X38 mm	
<b>OVEN:</b> FCV-E6, ECV-E6, ZCV-E6, RCV-E6, FCS061E		
Código fabricante / Manufacturer Code <b>002835</b>		

## ZANUSSI

	Referencia Code	<b>22288</b> ORIGINAL
	RESISTENCIA 9000W - 400V 440X38X40 mm	
	<b>HORNO:</b> AOS61E, FCZ061E, EJNI061E, RDR061E •••	
	HEATING ELEMENT 9000W - 400V 440X38X40 mm	
<b>OVEN:</b> AOS61E, FCZ061E, EJNI061E, RDR061E		
Código fabricante / Manufacturer Code <b>007030</b>		

	Referencia Code	<b>22284</b> ORIGINAL
	RESISTENCIA 17000W - 230V 470X36X40 mm	
	<b>HORNO:</b> FCVE10 •••	
	HEATING ELEMENT 17000W - 230V 470X36X40 mm	
<b>OVEN:</b> FCVE10		
Código fabricante / Manufacturer Code <b>55464</b>		

	Referencia Code	<b>22285</b> ORIGINAL
	RESISTENCIA 17000W - 230V 590X29X38 mm	
	<b>HORNO:</b> FCV-E10, FCV-E101 •••	
	HEATING ELEMENT 17000W - 230V 590X29X38 mm	
<b>OVEN:</b> FCV-E10, FCV-E101		
Código fabricante / Manufacturer Code <b>058995</b>		

	Referencia Code	<b>22289</b> ORIGINAL
	RESISTENCIA 17000W - 400V 450X39X41 mm	
	<b>HORNO:</b> AOS101E, AOW101E, FCZ101E •••	
	HEATING ELEMENT 17000W - 400V 450X39X41 mm	
<b>OVEN:</b> AOS101E, AOW101E, FCZ101E		
Código fabricante / Manufacturer Code <b>007076</b>		

# RESISTENCIAS HORNO / OVEN HEATING ELEMENTS

## ZANUSSI

Referencia Code **22287** ORIGINAL

RESISTENCIA  
24000W - 400V  
585X32X35 mm

**HORNO:** FCV-E10, ECV-E10, ZCV-E10, ACV-E10, FCV-E201, FCV-E202, ACV-E201, ACV-E202, ECV-E201, ECV/E202, ZCV-E201, ZCV-E202, FCS101E, FCS102E, FCS201E, FCS202E

• • •

HEATING ELEMENT  
24000W - 400V  
585X32X357 mm

**OVEN:** FCV-E10, ECV-E10, ZCV-E10, ACV-E10, FCV-E201, FCV-E202, ACV-E201, ACV-E202, ECV-E201, ECV/E202, ZCV-E201, ZCV-E202, FCS101E, FCS102E, FCS201E, FCS202E

\*CÓDIGO JUNTA / GASKET CODE  
19257

Código fabricante / Manufacturer Code **002751**

Referencia Code **22290** ORIGINAL

RESISTENCIA  
24000W - 400V  
570X40X40 mm

**HORNO:** AOS201E, AOS202E, AOS102E, FCZ102E, FCZ201E, FCZ202E, EJN102E, EJN201E, RDR201E, EJN202E

• • •

HEATING ELEMENT  
24000W - 400V  
570X40X40 mm

**OVEN:** AOS201E, AOS202E, AOS102E, FCZ102E, FCZ201E, FCZ202E, EJN102E, EJN201E, RDR201E, EJN202E

\*CÓDIGO JUNTA / GASKET CODE  
90808

Código fabricante / Manufacturer Code **007101**

## VARIOS

Referencia Code **20807** STANDARD

RESISTENCIA  
750W - 230V

**HORNO:** PIZZA

• • •

HEATING ELEMENT  
750W - 230V

**OVEN:** PIZZA

\*CÓDIGO JUNTA / GASKET CODE  
1248

## VARIOS

Referencia Code **32380** STANDARD

RESISTENCIA  
750W - 230V  
L = 530 mm

**HORNO:**

• • •

HEATING ELEMENT  
750W - 230V  
L = 530 mm

**OVEN:**

\*CÓDIGO JUNTA / GASKET CODE  
1248

Referencia Code **32388** STANDARD

RESISTENCIA  
1000W - 230V  
360X90 mm

**HORNO**

• • •

HEATING ELEMENT  
1000W - 230V  
360X90 mm

**OVEN**

Referencia Code **89748** STANDARD

RESISTENCIA  
1330W+2660W - 230V

**HORNO**

• • •

HEATING ELEMENT  
1330W+2660W - 230V

**OVEN**

Referencia Code **32384** STANDARD

RESISTENCIA  
1500W - 230V  
360X150 mm

**HORNO**

• • •

HEATING ELEMENT  
1500W - 230V  
360X150 mm

**OVEN**

# RESISTENCIAS HORNO / OVEN HEATING ELEMENTS

## VARIOS

	Referencia Code	<b>33020</b> STANDARD
		RESISTENCIA 1500W - 230V L = 1355 mm
	HORNO	HEATING ELEMENT 1500W - 230V L = 1355 mm
	OVEN	

	Referencia Code	<b>32382</b> STANDARD
		RESISTENCIA 2000W - 230V 360X210 mm
	HORNO	HEATING ELEMENT 2000W - 230V 360X210 mm
	OVEN	

	Referencia Code	<b>33021</b> STANDARD
		RESISTENCIA 2000W - 230V L = 1355 mm
	HORNO	HEATING ELEMENT 2000W - 230V L = 1355 mm
	OVEN	

## VARIOS

	Referencia Code	<b>89994</b> STANDARD
		RESISTENCIA 2000W - 230V 235X210 mm
	HORNO	HEATING ELEMENT 2000W - 230V 235X210 mm
	OVEN	

	Referencia Code	<b>32383</b> STANDARD
		RESISTENCIA 3000W - 230V 360X330 mm
	HORNO	HEATING ELEMENT 3000W - 230V 360X330 mm
	OVEN	

	Referencia Code	<b>84948</b> STANDARD
		RESISTENCIA 3000W - 230V ØINT: 192 mm - ØEXT: 205mm 220X36 mm
	HORNO	HEATING ELEMENT 3000W - 230V INNØ: 192 mm - EXTØ: 205 mm 220X36 mm
	OVEN	

# RESISTENCIAS MARMITA / BOILING PAN HEATING ELEMENTS

## ALPENINOX

	Referencia Code	<b>19255</b> ORIGINAL
		RESISTENCIA 4500W - 230V 385X40X40 mm
	MARMITA: SERIE 900	HEATING ELEMENT 4500W - 400V 385X40X40 mm
	BOILING PAN: SERIES 900	

Código fabricante / Manufacturer Code **A2484**

## ALPENINOX

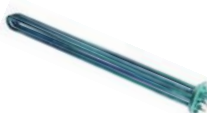
	Referencia Code	<b>19256</b> ORIGINAL
		RESISTENCIA 6000W - 230V 493X36X40 mm
	MARMITA: SERIE 900	HEATING ELEMENT 6000W - 400V 493X36X40 mm
	BOILING PAN: SERIES 900	

Código fabricante / Manufacturer Code **A2485**

# RESISTENCIAS MARMITA / BOILING PAN HEATING ELEMENTS

## AMBACH

Referencia  
Code **19263** ORIGINAL

RESISTENCIA  
300W - 230V  
207X22X22 mm / ROSCA 1"

MARMITA: ESK40, ESK60, ESK80, ESK100,  
ESK150, GNKE100, GNKE150, GNKE230,  
EKK40, EKK100, EKK150, EKK200, EKK250

HEATING ELEMENT  
300W - 400V  
207X22X22 mm / 1" THREAD

BOILING PAN: ESK40, ESK60, ESK80,  
ESK100, ESK150, GNKE100, GNKE150,  
GNKE230, EKK40, EKK100, EKK150,  
EKK200, EKK2503



\*CÓDIGO JUNTA / GASKET CODE  
31097

Código fabricante / Manufacturer Code **5024709751**

Referencia  
Code **19259** ORIGINAL

RESISTENCIA  
4500W - 230V  
395X30X40 mm

MARMITA: KKE75, KKE100, KKE130,  
EKS80

HEATING ELEMENT  
4500W - 230V  
395X30X40 mm

BOILING PAN: KKE75, KKE100, KKE130,  
EKS80



\*CÓDIGO JUNTA / GASKET CODE  
19257

Código fabricante / Manufacturer Code **5060810063**

Referencia  
Code **19260** ORIGINAL

RESISTENCIA  
6000W - 230V  
390X31X40 mm

MARMITA: KKE75, KKE100, KKE130,  
EKS80

HEATING ELEMENT  
6000W - 230V  
390X31X40 mm

BOILING PAN: KKE75, KKE100, KKE130,  
EKS80

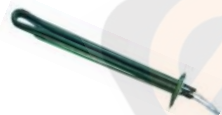

\*CÓDIGO JUNTA / GASKET CODE  
19257

Código fabricante / Manufacturer Code **5060810064**

Referencia  
Code **19258** ORIGINAL

RESISTENCIA  
8000W - 230V  
300X58X56 mm

MARMITA: K7E35, K7E50

HEATING ELEMENT  
8000W - 230V  
300X85X56 mm

BOILING PAN: K7E35, K7E50



Código fabricante / Manufacturer Code **5060807398**

## AMBACH

Referencia  
Code **19261** ORIGINAL

RESISTENCIA  
8000W - 230V  
385X32X44 mm

MARMITA: BPE50, KSKE50, KSKE100

HEATING ELEMENT  
8000W - 230V  
385X32X44 mm

BOILING PAN: BPE50, KSKE50, KSKE100



\*CÓDIGO JUNTA / GASKET CODE  
19257

Código fabricante / Manufacturer Code **5060809979**

Referencia  
Code **19262** ORIGINAL

RESISTENCIA  
10000W - 230V  
495X37X35 mm

MARMITA: GNKE100, GNKE150, EKK200,  
EKK250

HEATING ELEMENT  
10000W - 230V  
495X37X35 mm

BOILING PAN: GNKE100, GNKE150,  
EKK200, EKK250



\*CÓDIGO JUNTA / GASKET CODE  
19257

Código fabricante / Manufacturer Code **5060809980**

## ANGELO PO

Referencia  
Code **22202** ORIGINAL

RESISTENCIA  
4500W - 230V  
347X36X50 mm

MARMITA

HEATING ELEMENT  
4500W - 230V  
347X36X50 mm

BOILING PAN



\*CÓDIGO JUNTA / GASKET CODE  
90808

Código fabricante / Manufacturer Code **32G0400, 32G520, 32G920, 32G2580**

Referencia  
Code **19350** ORIGINAL

RESISTENCIA  
4540W - 400V  
312X55X48 mm

MARMITA: 31PIE6

HEATING ELEMENT  
4540W - 400V  
312X55X48 mm

BOILING PAN: 31PIE6



\*CÓDIGO JUNTA / GASKET CODE  
90808

Código fabricante / Manufacturer Code **32G1931**



# RESISTENCIAS MARMITA / BOILING PAN HEATING ELEMENTS

## ANGELO PO

	Referencia Code	<b>19351</b> ORIGINAL
	RESISTENCIA 7000W - 230V 405X42X70 mm	
	MARMITA: 71PIE15, 91PIE15, 91PIE15A, 71PIE15A ••• HEATING ELEMENT 7000W - 230V 405X42X70 mm	
BOILING PAN: 71PIE15, 91PIE15, 91PIE15A, 71PIE15A		
*CÓDIGO JUNTA / GASKET CODE 90808		

Código fabricante / Manufacturer Code **32G1030, 32G1031**

## BARON

	Referencia Code	<b>19773</b> ORIGINAL
	RESISTENCIA 8000W - 230V 470X42X31 mm	
	MARMITA: SERIE 700, SERIE 900 ••• HEATING ELEMENT 8000W - 230V 470X42X31 mm	
BOILING PAN: SERIE 700, SERIES 900		
*CÓDIGO JUNTA / GASKET CODE 90808		

Código fabricante / Manufacturer Code **853310185**

## 19352 ORIGINAL

	Referencia Code	<b>19352</b> ORIGINAL
	RESISTENCIA 7000W - 400V 415X41X84 mm	
	MARMITA: 1API12E, 1API12EA ••• HEATING ELEMENT 7000W - 400V 415X41X84 mm	
BOILING PAN: 1API12E, 1API12EA		
*CÓDIGO JUNTA / GASKET CODE 90808		

Código fabricante / Manufacturer Code **32G2330**

## BERTO'S

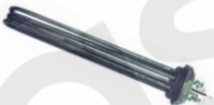
	Referencia Code	<b>19523</b> ORIGINAL
	RESISTENCIA 6000W - 230V 315X40X44 mm	
	MARMITA: E7PT ••• HEATING ELEMENT 6000W - 230V 315X40X44 mm	
BOILING PAN: E7PT		
*CÓDIGO JUNTA / GASKET CODE 31099		

Código fabricante / Manufacturer Code **31320200**

## BARON

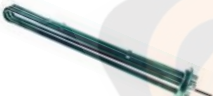
	Referencia Code	<b>19437</b> ORIGINAL
	RESISTENCIA 6000W - 230V 385X32X42 mm	
	MARMITA: SERIE 700, SERIE 900 ••• HEATING ELEMENT 6000W - 230V 385X32X42 mm	
BOILING PAN: SERIES 700, SERIES 900		
*CÓDIGO JUNTA / GASKET CODE 90808		

Código fabricante / Manufacturer Code **853310062**

## 22205 ORIGINAL

	Referencia Code	<b>22205</b> ORIGINAL
	RESISTENCIA 8000W - 230V 497X30X36 mm	
	MARMITA: E9P10 ••• HEATING ELEMENT 8000W - 230V 497X30X36 mm	
BOILING PAN: E9P10		
*CÓDIGO JUNTA / GASKET CODE 19257		

Código fabricante / Manufacturer Code **35039900**

## 20217 ORIGINAL

	Referencia Code	<b>20217</b> ORIGINAL
	RESISTENCIA 7500W - 230V 510X40X49 mm	
	MARMITA ••• HEATING ELEMENT 7500W - 230V 510X40X49 mm	
BOILING PAN		
*CÓDIGO JUNTA / GASKET CODE 90808		

Código fabricante / Manufacturer Code **6A037202**

## 22206 ORIGINAL

	Referencia Code	<b>22206</b> ORIGINAL
	RESISTENCIA 9000W - 230V 415X36X43 mm	
	MARMITA: E9P15 ••• HEATING ELEMENT 9000W - 230V 415X36X43 mm	
BOILING PAN: E9P15		
*CÓDIGO JUNTA / GASKET CODE 19257		

Código fabricante / Manufacturer Code **35040100**

# RESISTENCIAS MARMITA / BOILING PAN HEATING ELEMENTS

EMMEPI	
 <p>*CÓDIGO JUNTA / GASKET CODE 1248</p>	<b>Referencia Code</b> <b>22204</b> ORIGINAL
	RESISTENCIA 1800W - 230V 255X238X88 mm
	<b>MARMITA</b> ..... HEATING ELEMENT 1800W - 230V 255X238X88 mm
<b>BOILING PAN</b>	
<b>Código fabricante / Manufacturer Code</b> 806173	

EMMEPI	
 <p>*CÓDIGO JUNTA / GASKET CODE 19257</p>	<b>Referencia Code</b> <b>22206</b> ORIGINAL
	RESISTENCIA 9000W - 230V 415X36X43 mm
	<b>MARMITA:</b> EPE9150IP ..... HEATING ELEMENT 9000W - 230V 415X36X43 mm
<b>BOILING PAN:</b> EPE9150IP	
<b>Código fabricante / Manufacturer Code</b> 8C0230	

EMMEPI	
 <p>*CÓDIGO JUNTA / GASKET CODE 31099</p>	<b>Referencia Code</b> <b>19523</b> ORIGINAL
	RESISTENCIA 6000W - 230V 315X40X44 mm
	<b>MARMITA:</b> PE7050I, PE750I, PE9100I, PE9150I ..... HEATING ELEMENT 6000W - 230V 315X40X44 mm
<b>BOILING PAN:</b> PE7050I, PE750I, PE9100I, PE9150I	
<b>Código fabricante / Manufacturer Code</b> 808525	

GIGA	
 <p>*CÓDIGO JUNTA / GASKET CODE 19257</p>	<b>Referencia Code</b> <b>19610</b> ORIGINAL
	RESISTENCIA 8000W - 230V 315X37X35 mm
	<b>MARMITA:</b> KPI E, KPI EA ..... HEATING ELEMENT 8000W - 230V 315X37X35 mm
<b>BOILING PAN:</b> KPI E, KPI EA	
<b>Código fabricante / Manufacturer Code</b> Y15300	

EMMEPI	
 <p>*CÓDIGO JUNTA / GASKET CODE 90808</p>	<b>Referencia Code</b> <b>22203</b> ORIGINAL
	RESISTENCIA 7200W - 230V 485X34X48 mm
	<b>MARMITA</b> ..... HEATING ELEMENT 7200W - 230V 485X34X48 mm
<b>BOILING PAN</b>	
<b>Código fabricante / Manufacturer Code</b> 807788	

EMMEPI	
 <p>*CÓDIGO JUNTA / GASKET CODE 19257</p>	<b>Referencia Code</b> <b>22206</b> ORIGINAL
	RESISTENCIA 9000W - 230V 415X36X43 mm
	<b>MARMITA</b> ..... HEATING ELEMENT 8000W - 230V 315X37X35 mm
<b>BOILING PAN</b>	
<b>Código fabricante / Manufacturer Code</b> E11600, E404000042	

EMMEPI	
 <p>*CÓDIGO JUNTA / GASKET CODE 90740</p>	<b>Referencia Code</b> <b>19525</b> ORIGINAL
	RESISTENCIA 8000W - 230V 305X39X43 mm
	<b>MARMITA:</b> PE9100I, PE9150I ..... HEATING ELEMENT 8000W - 230V 305X39X43 mm
<b>BOILING PAN:</b> PE9100I, PE9150I	
<b>Código fabricante / Manufacturer Code</b> 808595	

JEMI	
 <p>*CÓDIGO JUNTA / GASKET CODE 10828</p>	<b>Referencia Code</b> <b>89502</b> ORIGINAL
	RESISTENCIA 6000W - 230V
	<b>MARMITA</b> ..... HEATING ELEMENT 8000W - 230V
<b>BOILING PAN</b>	
<b>Código fabricante / Manufacturer Code</b> 240101	

# RESISTENCIAS MARMITA / BOILING PAN HEATING ELEMENTS

## LAINOX

	Referencia Code	<b>22202</b> ORIGINAL
		RESISTENCIA 6000W - 230V 347X36X50 mm
	MARMITA:	FV03/06, ME05/40
	HEATING ELEMENT	6000W - 230V 347X36X50 mm
	BOILING PAN:	FV03/06, ME05/40
Código fabricante / Manufacturer Code		50303250, R65020270 R65020280, R65025100

\*CÓDIGO JUNTA / GASKET CODE  
90808

## MARENO

	Referencia Code	<b>19945</b> ORIGINAL
		RESISTENCIA 3400W - 230V 430X38X46 mm
	MARMITA:	PI70-7E
	HEATING ELEMENT	3400W - 230V 430X38X46 mm
	BOILING PAN:	PI70-7E
Código fabricante / Manufacturer Code		1677000

\*CÓDIGO JUNTA / GASKET CODE  
90814

## LOTUS

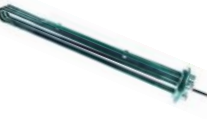
	Referencia Code	<b>19437</b> ORIGINAL
		RESISTENCIA 6000W - 230V 385X32X42 mm
	MARMITA:	PI100-98ET, PIA100-98ET
	HEATING ELEMENT	6000W - 230V 385X32X42 mm
	BOILING PAN:	PI100-98ET, PIA100-98ET
Código fabricante / Manufacturer Code		10062

\*CÓDIGO JUNTA / GASKET CODE  
90808

Referencia Code	<b>19952</b> ORIGINAL
-----------------	-----------------------

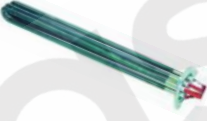
		RESISTENCIA 3400W - 230V 437X45X40 mm
	MARMITA:	SERIE 700 PROTAGONISTA
	HEATING ELEMENT	3400W - 230V 437X45X40 mm
		BOILING PAN:
Código fabricante / Manufacturer Code		CM183900

\*CÓDIGO JUNTA / GASKET CODE  
90808

Referencia Code	<b>19773</b> ORIGINAL
-----------------	-----------------------

		RESISTENCIA 8000W - 230V 470X42X31 mm
	MARMITA:	PI150-98ET, PIA150-98ET
	HEATING ELEMENT	8000W - 230V 470X42X31 mm
		BOILING PAN:
Código fabricante / Manufacturer Code		16600

\*CÓDIGO JUNTA / GASKET CODE  
90808

Referencia Code	<b>19951</b> ORIGINAL
-----------------	-----------------------

		RESISTENCIA 4000W - 230V 619X150 mm
	MARMITA:	SERIE 900 PROTAGONISTA
	HEATING ELEMENT	4000W - 230V 619X150 mm
		BOILING PAN:
Código fabricante / Manufacturer Code		CM096301

## MARENO

	Referencia Code	<b>19950</b> ORIGINAL
		RESISTENCIA 2000W - 230V 270X242X44 mm
	MARMITA:	P9D10E, P9D15E, P9I10E, P9IA10E
	HEATING ELEMENT	2000W - 230V 270X242X44 mm
	BOILING PAN:	P9D10E, P9D15E, P9I10E, P9IA10E
Código fabricante / Manufacturer Code		1414400

\*CÓDIGO JUNTA / GASKET CODE  
1248

Referencia Code	<b>22202</b> ORIGINAL
-----------------	-----------------------

		RESISTENCIA 6000W - 230V 347X36X50 mm
	MARMITA	
	HEATING ELEMENT	6000W - 230V 347X36X50 mm
		BOILING PAN
Código fabricante / Manufacturer Code		1037305500

\*CÓDIGO JUNTA / GASKET CODE  
90808

# RESISTENCIAS MARMITA / BOILING PAN HEATING ELEMENTS

## MARENO

	Referencia Code	<b>19947</b> ORIGINAL
	RESISTENCIA 6000W - 230V 584X70X65 mm	
MARMITA: P91-10E ● ● ●		
HEATING ELEMENT 6000W - 230V 584X70X65 mm		
BOILING PAN: P91-10E		
*CÓDIGO JUNTA / GASKET CODE 84649		

Código fabricante / Manufacturer Code **1878200**

	Referencia Code	<b>19948</b> ORIGINAL
	RESISTENCIA 7500W - 230V 580X66X64 mm	
MARMITA ● ● ●		
HEATING ELEMENT 7500W - 230V 580X66X64 mm		
BOILING PAN		

Código fabricante / Manufacturer Code **1878300**

	Referencia Code	<b>19954</b> ORIGINAL
	RESISTENCIA 7500W - 230V 590X48X65 mm	
MARMITA: SERIE 900 PROTAGONISTA ● ● ●		
HEATING ELEMENT 7500W - 230V 590X48X65 mm		
BOILING PAN: SERIES 900 PROTAGONISTA		
*CÓDIGO JUNTA / GASKET CODE 90808		

Código fabricante / Manufacturer Code **1878300**

## MBM

	Referencia Code	<b>22204</b> ORIGINAL
	RESISTENCIA 1800W - 230V 255X238X88 mm	
MARMITA: E100, E150, E100A, E150A ● ● ●		
HEATING ELEMENT 1800W - 230V 255X238X88 mm		
BOILING PAN: E100, E150, E100A, E150A		
*CÓDIGO JUNTA / GASKET CODE 1248		

Código fabricante / Manufacturer Code **RTCP900050**

## MBM

	Referencia Code	<b>22202</b> ORIGINAL
	RESISTENCIA 6000W - 230V 347X36X50 mm	
MARMITA: ES017 ● ● ●		
HEATING ELEMENT 6000W - 230V 347X36X50 mm		
BOILING PAN: ES017		
*CÓDIGO JUNTA / GASKET CODE 90808		

Código fabricante / Manufacturer Code **RTC0700619**

	Referencia Code	<b>22203</b> ORIGINAL
	RESISTENCIA 7200W - 230V 485X34X48 mm	
MARMITA: E100I9, E100IT9, E150I9, E150ITP, E150IA ● ● ●		
HEATING ELEMENT 7200W - 230V 485X34X48 mm		
BOILING PAN: E100I9, E100IT9, E150I9, E150ITP, E150IA		
*CÓDIGO JUNTA / GASKET CODE 90808		

Código fabricante / Manufacturer Code **RTC0700619**

## MODULAR

	Referencia Code	<b>22202</b> ORIGINAL
	RESISTENCIA 6000W - 230V 347X36X50 mm	
MARMITA ● ● ●		
HEATING ELEMENT 6000W - 230V 347X36X50 mm		
BOILING PAN		
*CÓDIGO JUNTA / GASKET CODE 90808		

Código fabricante / Manufacturer Code **---**

	Referencia Code	<b>22217</b> ORIGINAL
	RESISTENCIA 6000W - 230V 405X31X46 mm	
MARMITA: 70, 70PE1 ● ● ●		
HEATING ELEMENT 6000W - 230V 405X31X46 mm		
BOILING PAN: 70, 70PE1		
*CÓDIGO JUNTA / GASKET CODE 90808		

Código fabricante / Manufacturer Code **66502200**

# RESISTENCIAS MARMITA / BOILING PAN HEATING ELEMENTS

## MODULAR

	Referencia Code	<b>22218</b> ORIGINAL
		RESISTENCIA 8000W - 230V 510X43X30 mm
	MARMITA:	90, 80PEI • • • HEATING ELEMENT 8000W - 230V 510X43X30 mm
	BOILING PAN:	90, 80PEI
*CÓDIGO JUNTA / GASKET CODE 90808		
Código fabricante / Manufacturer Code		96502500

## OLIS

	Referencia Code	<b>20217</b> ORIGINAL
		RESISTENCIA 7500W - 230V 510X40X49 mm
	MARMITA:	911PEB, 915PEB • • • HEATING ELEMENT 7500W - 230V 510X40X49 mm
	BOILING PAN:	911PEB, 915PEB
*CÓDIGO JUNTA / GASKET CODE 90808		
Código fabricante / Manufacturer Code		A037202

## SILKO

	Referencia Code	<b>19523</b> ORIGINAL
		RESISTENCIA 6000W - 230V 315X40X44 mm / ROSCA 2"
	MARMITA:	PEB750, CPE7- • • • HEATING ELEMENT 6000W - 230V 315X40X44 mm / 2" THREAD
	BOILING PAN:	PEB750, CPE7- • • •
*CÓDIGO JUNTA / GASKET CODE 31099		
Código fabricante / Manufacturer Code		0101495

## ZANUSSI

	Referencia Code	<b>22209</b> ORIGINAL
		RESISTENCIA 750W - 230V 317X41X92 mm
	MARMITA:	HPN/E810, HPN/815, HPN/ED810, HPN/ED811, HPN/ED816, HPA/ED825 • • • HEATING ELEMENT 750W - 230V 317X41X92 mm
	BOILING PAN:	HPN/E810, HPN/815, HPN/ED810, HPN/ED811, HPN/ED816, HPA/ED825
*CÓDIGO JUNTA / GASKET CODE 19257		
Código fabricante / Manufacturer Code		59681, 51854, 51857

## ZANUSSI

	Referencia Code	<b>22210</b> ORIGINAL
		RESISTENCIA 1050W - 230V 425X42X95 mm
	MARMITA:	HPN/E810, HPN/815, HPN/ED810, HPN/ED811, HPN/ED816, HPA/ED825 • • • HEATING ELEMENT 1050W - 230V 425X42X95 mm
	BOILING PAN:	HPN/E810, HPN/815, HPN/ED810, HPN/ED811, HPN/ED816, HPA/ED825
*CÓDIGO JUNTA / GASKET CODE 90808		
Código fabricante / Manufacturer Code		59680, 51855, 51858

	Referencia Code	<b>22211</b> ORIGINAL
		RESISTENCIA 1250W - 230V 485X44X95 mm
	MARMITA:	HPN/E810, HPN/815, HPN/ED810, HPN/ED811, HPN/ED816, HPA/ED825 • • • HEATING ELEMENT 1250W - 230V 485X44X95 mm
	BOILING PAN:	HPN/E810, HPN/815, HPN/ED810, HPN/ED811, HPN/ED816, HPA/ED825
*CÓDIGO JUNTA / GASKET CODE 90808		
Código fabricante / Manufacturer Code		59679, 51856, 51859

	Referencia Code	<b>22207</b> ORIGINAL
		RESISTENCIA 4700W - 230V 393X40 mm
	MARMITA:	RPN/EI 660, MPN/EI 760, MPI/E 240, MPI/E 260, MPI/E 260P, PPNEI 740, PPNEI 760, PPNEI 761, HPN/EI 805, HPN/EI 806 • • • HEATING ELEMENT 4700W - 230V 393X40 mm
	BOILING PAN:	RPN/EI 660, MPN/EI 760, MPI/E 240, MPI/E 260, MPI/E 260P, PPNEI 740, PPNEI 760, PPNEI 761, HPN/EI 805, HPN/EI 806
*CÓDIGO JUNTA / GASKET CODE 19257		
Código fabricante / Manufacturer Code		49307, 02524, 26453, 57698

# RESISTENCIAS MARMITA / BOILING PAN HEATING ELEMENTS

## ZANUSSI

	Referencia Code	<b>22212</b> ORIGINAL
	RESISTENCIA	6000W - 230V 479X36X33 mm
	MARMITA: HPE/EI 815, HPN/EI 917, HPN/EI 1225, HQN/EI	• • • HEATING ELEMENT 6000W - 230V 479X36X33 mm
*CÓDIGO JUNTA / GASKET CODE	19257	
Código fabricante / Manufacturer Code <b>51632, 51633</b>		

## ZANUSSI

	Referencia Code	<b>22213</b> ORIGINAL
	RESISTENCIA	6000W - 230V 465X38X24 mm
	MARMITA: HPN/EI 917, HPN/EI 1225, PQN/EI__	• • • HEATING ELEMENT 6000W - 230V 465X38X24 mm
*CÓDIGO JUNTA / GASKET CODE	19257	
Código fabricante / Manufacturer Code <b>45559, 66110, 58011, 76035</b>		

## ZANUSSI

	Referencia Code	<b>22214</b> ORIGINAL
	RESISTENCIA	7500W - 230V 550X37X37 mm
	MARMITA: NPN/EI_, HPNS/EI_, HPA/EI_ (2ª Generación)	• • • HEATING ELEMENT 7500W - 230V 550X37X37 mm
*CÓDIGO JUNTA / GASKET CODE	19257	
Código fabricante / Manufacturer Code <b>59665</b>		

## ZANUSSI

	Referencia Code	<b>22215</b> ORIGINAL
	RESISTENCIA	10750W - 230V 542X35X26 mm
	MARMITA: NPEI 810, NPEI 815	• • • HEATING ELEMENT 10750W - 230V 542X35X26 mm
*CÓDIGO JUNTA / GASKET CODE	19257	
Código fabricante / Manufacturer Code <b>0C0715</b>		

# RESISTENCIAS MESA CALIENTE / HOT CUPBOARD TABLE HEATING ELEMENTS

## FRANKE

	Referencia Code	<b>48138</b> ORIGINAL
	RESISTENCIA CUBA	1200W - 230V 395X220X24 mm
	MESA CALIENTE: BM, ABM-EMA	• • • TANK HEATING ELEMENT 1200W - 230V 395X220X24 mm
HOT CUPBOARD TABLE: BM, ABM-EMA		
Código fabricante / Manufacturer Code <b>3710003</b>		

## TECFRIGO

	Referencia Code	<b>48273</b> ORIGINAL
	RESISTENCIA	700W - 230V
	MESA CALIENTE: OASI 8	• • • HEATING ELEMENT 700W - 230V
HOT CUPBOARD TABLE: OASI 8		
Código fabricante / Manufacturer Code <b>3224801</b>		

# RESISTENCIAS PLANCHA/FRY-TOP / HOT PLATE/FRY-TOP HEATING ELEMENTS

## ALPENINOX

Referencia Code **19079** ORIGINAL



RESISTENCIA  
1500W - 230V  
242X155X120 mm

FRY-TOP: 720-\_\_

HEATING ELEMENT  
1500W - 230V  
242X155X120 mm

FRY-TOP: 720-\_\_

Código fabricante / Manufacturer Code **A2070**

Referencia Code **19080** ORIGINAL



RESISTENCIA  
1500W - 230V  
380X80X124 mm

FRY-TOP: 740-\_\_

HEATING ELEMENT  
1500W - 230V  
380X80X124 mm

FRY-TOP: 740-\_\_

Código fabricante / Manufacturer Code **A2208**

Referencia Code **19081** ORIGINAL



RESISTENCIA  
1500W - 230V  
533X75X123 mm

FRY-TOP: SERIE 900

HEATING ELEMENT  
1500W - 230V  
533X75X123 mm

FRY-TOP: SERIES 900

Código fabricante / Manufacturer Code **A2068, A2247**

## AMBACH

Referencia Code **19219** ORIGINAL



RESISTENCIA  
2000W - 230V  
600X305X90 mm

FRY-TOP: EBP45, EBP90

HEATING ELEMENT  
2000W - 230V  
600X305X90 mm

FRY-TOP: EBP45, EBP90

Código fabricante / Manufacturer Code **5060814401**

## AMBACH

Referencia Code **19220** ORIGINAL



RESISTENCIA  
2000W - 230V  
600X305X90 mm

FRY-TOP: EBP45, EBP90

HEATING ELEMENT  
2000W - 230V  
600X305X90 mm

FRY-TOP: EBP45, EBP90

Código fabricante / Manufacturer Code **5060814402**

Referencia Code **19221** ORIGINAL

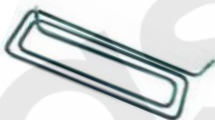

RESISTENCIA  
2000W - 230V  
480X154X92 mm

FRY-TOP: EBP45, EBP90

HEATING ELEMENT  
2000W - 230V  
600X305X90 mm

FRY-TOP: EBP45, EBP90

Código fabricante / Manufacturer Code **5060814403**

Referencia Code **19216** ORIGINAL



RESISTENCIA  
5000W - 230V  
506X275 mm

FRY-TOP: EBP35, EBP70

HEATING ELEMENT  
5000W - 230V  
506X275 mm

FRY-TOP: EBP35, EBP70

Código fabricante / Manufacturer Code **5060903508**

Referencia Code **19217** ORIGINAL



RESISTENCIA  
5000W - 230V  
506X265 mm

FRY-TOP: EBP40, EBP80

HEATING ELEMENT  
5000W - 230V  
506X265 mm

FRY-TOP: EBP40, EBP80

Código fabricante / Manufacturer Code **5060903506**

# RESISTENCIAS PLANCHA/FRY-TOP / HOT PLATE/FRY-TOP HEATING ELEMENTS

## AMBACH

Referencia  
Code **19218** ORIGINAL



RESISTENCIA  
6000W - 230V  
540X315 mm

FRY-TOP: GE40, GE80

HEATING ELEMENT  
6000W - 230V  
540X315 mm

FRY-TOP: GE40, GE80

Código fabricante / Manufacturer Code **5060803509**

## ANGELO PO

Referencia  
Code **19412** ORIGINAL



RESISTENCIA  
2200W - 400V  
572X81X85 mm

FRY-TOP: SENIOR

HEATING ELEMENT  
2200W - 400V  
572X81X85 mm

FRY-TOP: SENIOR

Código fabricante / Manufacturer Code **3261870**

## ANGELO PO

Referencia  
Code **19408** ORIGINAL



RESISTENCIA  
550W - 230V  
540X22.5 mm

FRY-TOP: COMBI, 061FTE

HEATING ELEMENT  
550W - 400V  
540X22.5 mm

FRY-TOP: JUNIOR

Código fabricante / Manufacturer Code **3260050**

Referencia  
Code **19413** ORIGINAL



RESISTENCIA  
2200W - 230V  
615X86X92 mm

FRY-TOP: DELTA, OMEGA

HEATING ELEMENT  
2200W - 230V  
615X86X92 mm

FRY-TOP: DELTA, OMEGA

Código fabricante / Manufacturer Code **3262370**

## BARON

Referencia  
Code **20204** ORIGINAL



RESISTENCIA  
900W - 230V  
435X80X45 mm

FRY-TOP: SERIE 700

HEATING ELEMENT  
900W - 230V  
435X80X45 mm

FRY-TOP: SERIE 700

Código fabricante / Manufacturer Code **6A037250**

Referencia  
Code **19410** ORIGINAL



RESISTENCIA  
1700W - 400V  
445X75X83 mm

FRY-TOP: JUNIOR

HEATING ELEMENT  
1700W - 400V  
445X75X83 mm

FRY-TOP: JUNIOR

Código fabricante / Manufacturer Code **3261040**

Referencia  
Code **19409** ORIGINAL



RESISTENCIA  
1750W - 230V  
445X80X55 mm

FRY-TOP: JUNIOR

HEATING ELEMENT  
1705W - 400V  
445X80X55 mm

FRY-TOP: JUNIOR

Código fabricante / Manufacturer Code **3261262**

Referencia  
Code **19491** ORIGINAL



RESISTENCIA  
1250W - 230V  
407X88X20 mm

FRY-TOP: SERIE 700

HEATING ELEMENT  
1250W - 230V  
407X88X20 mm

FRY-TOP: SERIE 700

Código fabricante / Manufacturer Code **826620070**



# RESISTENCIAS PLANCHA/FRY-TOP / HOT PLATE/FRY-TOP HEATING ELEMENTS

## BARON

Referencia  
Code **19492** ORIGINAL



RESISTENCIA  
2660W - 230V  
555X100X23 mm

FRY-TOP: SERIE 900

HEATING ELEMENT  
2660W - 230V  
555X100X23 mm

FRY-TOP: SERIES 900

Código fabricante / Manufacturer Code **826620060**

## DOSSILET

Referencia  
Code **18096** STANDARD



RESISTENCIA  
1150W - 230V  
208X210 mm

FRY-TOP

HEATING ELEMENT  
1150W - 230V  
208X210 mm

FRY-TOP

## EMMEPI

Referencia  
Code **19537** ORIGINAL

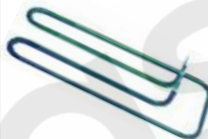

RESISTENCIA  
1000W - 230V  
220X103X32 mm

FRY-TOP: SERIE 650, SERIE 700

HEATING ELEMENT  
1000W - 230V  
220X103X32 mm

FRY-TOP: SERIES 650, SERIES 700

Código fabricante / Manufacturer Code **C10199**

## BECKERS

Referencia  
Code **48879** ORIGINAL



RESISTENCIA  
1000W - 230V

FRY-TOP: SERIE 900

HEATING ELEMENT  
1000W - 230V

FRY-TOP: SERIES 900

Código fabricante / Manufacturer Code **0503391 R1**

Referencia  
Code **19533** ORIGINAL



RESISTENCIA  
1800W - 230V  
290X130X30 mm

FRY-TOP: SERIE 700, SERIE 750, SERIE 900

HEATING ELEMENT  
1800W - 230V  
290X130X30 mm

FRY-TOP: SERIES 700, SERIES 750, SERIES 900

Código fabricante / Manufacturer Code **C00644**

## BERTO'S

Referencia  
Code **84950** STANDARD



RESISTENCIA  
750W - 230V  
180X170X18 mm

FRY-TOP

HEATING ELEMENT  
750W - 230V  
180X170X18 mm

FRY-TOP

Referencia  
Code **19608** ORIGINAL



RESISTENCIA  
1500W - 230V  
425X72X53 mm

FRY-TOP

HEATING ELEMENT  
1500W - 230V  
425X72X53 mm

FRY-TOP

Código fabricante / Manufacturer Code **22039300**

## FAGOR

Referencia  
Code **16751** ORIGINAL



RESISTENCIA  
1500W - 230V  
517X87X71 mm

FRY-TOP: FTE7-05, FTE7-10

HEATING ELEMENT  
1500W - 230V  
517X87X71 mm

FRY-TOP: FTE7-05, FTE7-10

Código fabricante / Manufacturer Code **R893000000**

# RESISTENCIAS PLANCHA/FRY-TOP / HOT PLATE/FRY-TOP HEATING ELEMENTS

## FAGOR

Referencia  
Code **16745** ORIGINAL



RESISTENCIA  
2000W - 230V  
585X100X100 mm

FRY-TOP: FTE9-8, FTE9-10

HEATING ELEMENT  
2000W - 230V  
585X100X100 mm

FRY-TOP: FTE9-8, FTE9-10

Código fabricante / Manufacturer Code **R573010000**

Referencia  
Code **20267** ORIGINAL



RESISTENCIA  
2000W - 230V  
568X77X86 mm

FRY-TOP: FTE-905, FTE-910

HEATING ELEMENT  
2000W - 230V  
568X77X86 mm

FRY-TOP: FTE-905, FTE-910

Código fabricante / Manufacturer Code **R573000000**

## GIGA

Referencia  
Code **19608** ORIGINAL



RESISTENCIA  
1500W - 230V  
425X72X53 mm

FRY-TOP: SKT\_E/ER/ELR, CFTE\_  
TT\_E/EC/ER, TT\_E2/EC2/ELR

HEATING ELEMENT  
1500W - 230V  
425X72X53 mm

FRY-TOP: SKT\_E/ER/ELR, CFTE\_  
TT\_E/EC/ER, TT\_E2/EC2/ELR

Código fabricante / Manufacturer Code **X45700**

Referencia  
Code **19609** ORIGINAL



RESISTENCIA  
2560W - 230V  
590X77X80 mm

FRY-TOP: KFTE\_

HEATING ELEMENT  
2560W - 230V  
590X77X80 mm

FRY-TOP: KFTE\_

Código fabricante / Manufacturer Code **Y10400**

## INFRICO

Referencia  
Code **51061** ORIGINAL



RESISTENCIA SUPERIOR  
850W - 230V  
210X230 mm

FRY-TOP: GR42

UPPER HEATING ELEMENT  
850W - 230V  
210X230 mm

FRY-TOP: GR42

Código fabricante / Manufacturer Code **2800X0012**

Referencia  
Code **51060** ORIGINAL



RESISTENCIA INFERIOR  
1150W - 230V  
210X230 mm

FRY-TOP: GR42

LOWER HEATING ELEMENT  
1150W - 230V  
210X230 mm

FRY-TOP: GR42

Código fabricante / Manufacturer Code **2800X0011**

## JEMI

Referencia  
Code **20368** ORIGINAL



RESISTENCIA  
800W - 230V  
365X40 mm

FRY-TOP: SERIE 600, SERIE 700, SERIE 750

HEATING ELEMENT  
800W - 230V  
365X40 mm

FRY-TOP: SERIES 600, SERIES 700, SERIES 750

Código fabricante / Manufacturer Code **240055**

Referencia  
Code **20369** ORIGINAL



RESISTENCIA  
1250W - 230V  
540X40 mm

FRY-TOP: SERIE 900, SERIE 1000

HEATING ELEMENT  
1250W - 230V  
540X40 mm

FRY-TOP: SERIES 900, SERIES 1000

Código fabricante / Manufacturer Code **240056**

# RESISTENCIAS PLANCHA/FRY-TOP / HOT PLATE/FRY-TOP HEATING ELEMENTS

## JEMI

Referencia  
Code **20370** ORIGINAL



RESISTENCIA  
1650W - 230V  
700X40 mm

FRY-TOP: SERIE 1300

HEATING ELEMENT  
1650W - 230V  
700X40 mm

FRY-TOP: SERIES 1300

Código fabricante / Manufacturer Code **240057**

## LOTUS

Referencia  
Code **19777** ORIGINAL



RESISTENCIA  
1500W - 230V  
498X158X59 mm

FRY-TOP: 700 FT-74ET, FT-78ET, FT-712ET,  
FTT74ET, FTT-78ET

HEATING ELEMENT  
1500W - 230V  
498X158X59 mm

FRY-TOP: 700 FT-74ET, FT-78ET, FT-712ET,  
FTT74ET, FTT-78ET

Código fabricante / Manufacturer Code **53.7.0210.00**

## KLAXON

Referencia  
Code **47621** ORIGINAL



RESISTENCIA  
2100W - 230V

FRY-TOP: PE-80

HEATING ELEMENT  
2100W - 230V

FRY-TOP: PE-80

Código fabricante / Manufacturer Code ---

Referencia  
Code **19778** ORIGINAL



RESISTENCIA  
1900W - 230V  
397X220X20 mm

FRY-TOP: FTC-61EM, FTC-62EM, FTC-62ET

HEATING ELEMENT  
1900W - 230V  
397X220X20 mm

FRY-TOP: FTC-61EM, FTC-62EM, FTC-62ET

Código fabricante / Manufacturer Code **53.7.0147.00**

## LOTUS

Referencia  
Code **19775** ORIGINAL

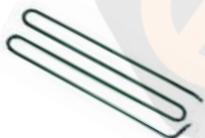

RESISTENCIA  
1000W - 230V  
333X80X64 mm

FRY-TOP: FT-61ET, FT-62ET, FT-63ET,  
FT-64ET

HEATING ELEMENT  
1000W - 230V  
333X80X64 mm

FRY-TOP: FT-61ET, FT-62ET, FT-63ET,  
FT-64ET

Código fabricante / Manufacturer Code **53.7.0051.00**

Referencia  
Code **19779** ORIGINAL



RESISTENCIA  
2000W - 230V  
660X85X60 mm

FRY-TOP: FT-94ET, FT-98ET

HEATING ELEMENT  
2000W - 230V  
660X85X60 mm

FRY-TOP: FT-94ET, FT-98ET

Código fabricante / Manufacturer Code **53.7.0252.00**

Referencia  
Code **19776** ORIGINAL



RESISTENCIA  
1500W - 230V  
425X90X70 mm

FRY-TOP: 650 FT-4EM, FT-6EM, FT-8EM,  
FT-4ET, FT-6ET, FT-8ET

HEATING ELEMENT  
1500W - 230V  
425X90X70 mm

FRY-TOP: 650 FT-4EM, FT-6EM, FT-8EM,  
FT-4ET, FT-6ET, FT-8ET

Código fabricante / Manufacturer Code **53.7.0052.00**

Referencia  
Code **19774** ORIGINAL



RESISTENCIA  
2400W - 230V  
342X227X53 mm

FRY-TOP: FTLR

HEATING ELEMENT  
2400W - 230V  
342X227X53 mm

FRY-TOP: FTLR

Código fabricante / Manufacturer Code **53.7.0041.00**

# RESISTENCIAS PLANCHA/FRY-TOP / HOT PLATE/FRY-TOP HEATING ELEMENTS

## LOTUS

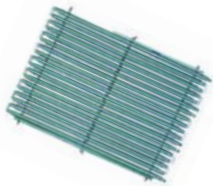
	Referencia Code	<b>19780</b> ORIGINAL
		RESISTENCIA 3240W - 230V 390X265X30 mm
		<b>FRY-TOP:</b> 650 FTC-4EM, FTC-4ET, FTC-8ET, FTC-4EMX, FTC-8EMX • • •
		HEATING ELEMENT 3240W - 230V 390X265X30 mm
		<b>FRY-TOP:</b> 650 FTC-4EM, FTC-4ET, FTC-8ET, FTC-4EMX, FTC-8EMX
Código fabricante / Manufacturer Code		53.7.0131.00

## MARENO

	Referencia Code	<b>19892</b> ORIGINAL
		RESISTENCIA 1600W - 230V 417X57X90 mm
		<b>FRY-TOP:</b> 700 FT7-4EL, FT7-4ER, FT7-6EL, FT7-6ELC, FT7-6EM, FT7-6EMC, FT7-8EL, FT7-8ELC, FT7-8EM, FT7-8EMC • • •
		HEATING ELEMENT 1600W - 230V 417X57X90 mm
		<b>FRY-TOP:</b> 700 FT7-4EL, FT7-4ER, FT7-6EL, FT7-6ELC, FT7-6EM, FT7-6EMC, FT7-8EL, FT7-8ELC, FT7-8EM, FT7-8EMC
Código fabricante / Manufacturer Code		CM164800

## MARENO

	Referencia Code	<b>19888</b> ORIGINAL
		RESISTENCIA 1300W - 230V 490X78X70 mm
		<b>FRY-TOP:</b> FTE-, BIE-, SERIE 600 • • •
		HEATING ELEMENT 1300W - 230V 490X78X70mm
		<b>FRY-TOP:</b> FTE-, BIE-, SERIES 600
Código fabricante / Manufacturer Code		10.37300700

	Referencia Code	<b>19890</b> ORIGINAL
		RESISTENCIA 1800W - 230V 488X84X63 mm
		<b>FRY-TOP:</b> FT7-E/ER/ERL (2º SERIE 700) • • •
		HEATING ELEMENT 1800W - 230V 488X84X63 mm
		<b>FRY-TOP:</b> FT7-E/ER/ERL (2nd SERIES 700)
Código fabricante / Manufacturer Code		1730000

## MARENO

	Referencia Code	<b>19891</b> ORIGINAL
		RESISTENCIA 1300W - 230V 405X85X100 mm
		<b>FRY-TOP</b> • • •
		HEATING ELEMENT 1300W - 230V 405X85X100mm
		<b>FRY-TOP</b>
Código fabricante / Manufacturer Code		1941800

	Referencia Code	<b>19896</b> ORIGINAL
		RESISTENCIA 1900W - 230V 585X90X80 mm
		<b>FRY-TOP:</b> SERIE 900 • • •
		HEATING ELEMENT 1900W - 230V 585X90X80 mm
		<b>FRY-TOP:</b> SERIE 900
Código fabricante / Manufacturer Code		1941900

## MARENO

	Referencia Code	<b>19894</b> ORIGINAL
		RESISTENCIA 1400W - 230V 583X50X36 mm
		<b>FRY-TOP:</b> FTC2E, FTC4E • • •
		HEATING ELEMENT 1400W - 230V 583X50X36mm
		<b>FRY-TOP:</b> FTC2E, FTC4E
Código fabricante / Manufacturer Code		167622

	Referencia Code	<b>19895</b> ORIGINAL
		RESISTENCIA 2000W - 230V 600X80X70 mm
		<b>FRY-TOP:</b> FTC2E, FTC2ER, FTC4E, FTC4ER, FTC4ERL • • •
		HEATING ELEMENT 2000W - 230V 600X80X70 mm
		<b>FRY-TOP:</b> FTC2E, FTC2ER, FTC4E, FTC4ER- FTC4ERL
Código fabricante / Manufacturer Code		1029200

# RESISTENCIAS PLANCHA/FRY-TOP / HOT PLATE/FRY-TOP HEATING ELEMENTS

## MARENO

	Referencia Code	<b>19893</b> ORIGINAL
		RESISTENCIA 2200W - 230V 420X130X92 mm
	FRY-TOP	• • •
		HEATING ELEMENT 2200W - 230V 420X130X92 mm
	FRY-TOP	
Código fabricante / Manufacturer Code <b>CM165100</b>		

	Referencia Code	<b>19897</b> ORIGINAL
		RESISTENCIA 2200W - 230V 565X110X118 mm
	FRY-TOP: SERIE 900 PROTAGONISTA	• • •
		HEATING ELEMENT 2200W - 230V 565X110X118 mm
	FRY-TOP: SERIES 900 PROTAGONISTA	
Código fabricante / Manufacturer Code <b>CM164900</b>		

	Referencia Code	<b>19898</b> ORIGINAL
		RESISTENCIA 3300W - 230V 570X130X90 mm
	FRY-TOP: SERIE 900 M60	• • •
		HEATING ELEMENT 3300W - 230V 570X130X90 mm
	FRY-TOP: SERIES 900 M60	
Código fabricante / Manufacturer Code <b>CM165200</b>		

## MBM

	Referencia Code	<b>22059</b> ORIGINAL
		RESISTENCIA 1250W - 230V 416X70X65 mm
	FRY-TOP: MINIMA EFT46-EFT66-EFT106	• • •
		HEATING ELEMENT 1250W - 230V 416X70X65 mm
	FRY-TOP: MINIMA EFT46-EFT66-EFT106	
Código fabricante / Manufacturer Code <b>RTCU600183</b>		

## MBM

	Referencia Code	<b>22062</b> ORIGINAL
		RESISTENCIA 1350W - 230V 450X82X64 mm
	FRY-TOP: OMNIA, EFT47/77	• • •
		HEATING ELEMENT 1350W - 230V 450X82X64 mm
	FRY-TOP: OMNIA, EFT47/77	
Código fabricante / Manufacturer Code <b>RTCU700278</b>		

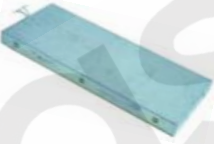
	Referencia Code	<b>22060</b> ORIGINAL
		RESISTENCIA 1500W - 230V 452X196 mm
	FRY-TOP: MINIMA ECFT66	• • •
		HEATING ELEMENT 1500W - 230V 452X196 mm
	FRY-TOP: MINIMA ECFT66	
Código fabricante / Manufacturer Code <b>RIC0002068</b>		

	Referencia Code	<b>22063</b> ORIGINAL
		RESISTENCIA 1500W - 230V 570X90X68 mm
	FRY-TOP: EFT45/90	• • •
		HEATING ELEMENT 1500W - 230V 570X90X68 mm
	FRY-TOP: EFT45/90	
Código fabricante / Manufacturer Code <b>RTBF900068</b>		

	Referencia Code	<b>22064</b> ORIGINAL
		RESISTENCIA 2000W - 230V 570X92X65 mm
	FRY-TOP: EFT-	• • •
		HEATING ELEMENT 2000W - 230V 570X92X65 mm
	FRY-TOP: EFT-	
Código fabricante / Manufacturer Code <b>RTBF800038</b>		

# RESISTENCIAS PLANCHA/FRY-TOP / HOT PLATE/FRY-TOP HEATING ELEMENTS

## MBM

	Referencia Code	<b>22061</b> ORIGINAL
		RESISTENCIA 2500W - 230V 452X276 mm
		FRY-TOP: ECFT66  • • •
		HEATING ELEMENT 2500W - 230V 452X276 mm
		FRY-TOP: ECFT66
Código fabricante / Manufacturer Code		RIC0002063

## MODULAR

	Referencia Code	<b>20026</b> ORIGINAL
		RESISTENCIA 1800W - 230V 470X90X65 mm
		FRY-TOP: SERIE 700  • • •
		HEATING ELEMENT 1800W - 230V 470X90X65 mm
		FRY-TOP: SERIE 700
Código fabricante / Manufacturer Code		665.002.00

## MIRROR

	Referencia Code	<b>85928</b> ORIGINAL
		RESISTENCIA 1333W - 230V
		PLANCHA: 1333Z  • • •
		HEATING ELEMENT 1333W - 230V
		HOT PLATE: 1333Z
Código fabricante / Manufacturer Code		R1333Z

	Referencia Code	<b>20027</b> ORIGINAL
		RESISTENCIA 2000W - 230V 650X78X72 mm
		FRY-TOP  • • •
		HEATING ELEMENT 2000W - 230V 650X78X72 mm
		FRY-TOP
Código fabricante / Manufacturer Code		965.000.00

	Referencia Code	<b>85929</b> ORIGINAL
		RESISTENCIA 1333W - 230V L = 400 mm
		PLANCHA: 1333M  • • •
		HEATING ELEMENT 1333W - 230V L = 400 mm
		HOT PLATE: 1333M
Código fabricante / Manufacturer Code		R1333M

## MUNDIGAS

	Referencia Code	<b>34461</b> ORIGINAL
		RESISTENCIA 1333W - 380V
		PLANCHA  • • •
		HEATING ELEMENT 1333W - 380V
		HOT PLATE
Código fabricante / Manufacturer Code		---

## MODULAR

	Referencia Code	<b>20025</b> ORIGINAL
		RESISTENCIA 1000W - 230V 422X70X66 mm
		FRY-TOP: 60FTE, 60FTRE, 60FTRRE  • • •
		HEATING ELEMENT 1000W - 230V 422X70X66 mm
		FRY-TOP: 60FTE, 60FTRE, 60FTRRE
Código fabricante / Manufacturer Code		66505700

## OLIS

	Referencia Code	<b>20203</b> ORIGINAL
		RESISTENCIA 1300W - 230V 515X580 mm
		FRY-TOP: SERIE 600  • • •
		HEATING ELEMENT 1300W - 230V 515X580 mm
		FRY-TOP: SERIE 600
Código fabricante / Manufacturer Code		8217700

# RESISTENCIAS PLANCHA/FRY-TOP / HOT PLATE/FRY-TOP HEATING ELEMENTS

## OLIS

	Referencia Code	<b>20204</b> ORIGINAL
		RESISTENCIA 900W - 230V 435X80X45 mm
		FRY-TOP: 74FTE, 78FTE ..... HEATING ELEMENT 900W - 230V 435X80X45 mm
		FRY-TOP: 74FTE
Código fabricante / Manufacturer Code		A037250

	Referencia Code	<b>20203</b> ORIGINAL
		RESISTENCIA 1300W - 230V 475X83X66 mm
		FRY-TOP: SERIE 600 ..... HEATING ELEMENT 1300W - 230V 475X83X66 mm
		FRY-TOP: SERIES 600
Código fabricante / Manufacturer Code		8217700

	Referencia Code	<b>20205</b> ORIGINAL
		RESISTENCIA 1700W - 230V 440X90X64 mm
		FRY-TOP: SERIE 600 ..... HEATING ELEMENT 1700W - 230V 440X90X64 mm
		FRY-TOP: SERIES 600
Código fabricante / Manufacturer Code		A044706

	Referencia Code	<b>20206</b> ORIGINAL
		RESISTENCIA 2660W - 230V 578X88X63 mm
		FRY-TOP: SERIE 900 ..... HEATING ELEMENT 2660W - 230V 578X88X63 mm
		FRY-TOP: SERIES 900
Código fabricante / Manufacturer Code		A037450

## REPAGAS

	Referencia Code	<b>7973</b> ORIGINAL
		RESISTENCIA 1000W - 230V 345X55X70 mm
		FRY-TOP: E35, E65, E95 ..... HEATING ELEMENT 1000W - 230V 345X55X70 mm
		FRY-TOP: E35, E65, E95
Código fabricante / Manufacturer Code		32100002

	Referencia Code	<b>7971</b> ORIGINAL
		RESISTENCIA 1300W - 230V 300X130X70 mm
		FRY-TOP: E60, E64, E80, E84 ..... HEATING ELEMENT 1300W - 230V 300X130X70 mm
		FRY-TOP: E60, E64, E80, E84
Código fabricante / Manufacturer Code		32400014

## SAMMIC

	Referencia Code	<b>86120</b> ORIGINAL
		RESISTENCIA 1150W - 230V 210X225 mm
		PLANCHA: GRS, GRD, GLD, GRL ..... HEATING ELEMENT 1150W - 230V 210X225 mm
		HOT PLATE: GRS, GRD, GLD, GRL
Código fabricante / Manufacturer Code		6100053

## SILANOS

	Referencia Code	<b>83608</b> ORIGINAL
		RESISTENCIA 1400W - 230V 380X165 mm
		PLANCHA ..... HEATING ELEMENT 1400W - 230V 380X165 mm
		HOT PLATE

# RESISTENCIAS PLANCHA/FRY-TOP / HOT PLATE/FRY-TOP HEATING ELEMENTS

## SILKO

	Referencia Code <b>84631</b> ORIGINAL
	RESISTENCIA 1350W - 230V 435X46 mm - ROSCA 1/4"
	FRY-TOP ••• HEATING ELEMENT 1350W - 230V 435X46 mm - 1/4" THREAD
*CÓDIGO JUNTA / GASKET CODE 1248	
Código fabricante / Manufacturer Code <b>0101529</b>	

Código fabricante / Manufacturer Code **0101529**

## SILKO

	Referencia Code <b>19608</b> ORIGINAL
	RESISTENCIA 1500W - 230V 425X72X53 mm
	FRY-TOP ••• HEATING ELEMENT 1500W - 230V 425X72X53 mm
Código fabricante / Manufacturer Code <b>0109041</b>	

Código fabricante / Manufacturer Code **0109041**

## SILKO

	Referencia Code <b>19897</b> ORIGINAL
	RESISTENCIA 2200W - 230V 565X110X118 mm
	FRY-TOP ••• HEATING ELEMENT 2200W - 230V 565X110X118 mm
Código fabricante / Manufacturer Code <b>0105155</b>	

Código fabricante / Manufacturer Code **0105155**

## SIRMAN

	Referencia Code <b>95461</b> ORIGINAL
	RESISTENCIA 700W - 230V 180X175X15 mm
	FRY-TOP: CORT, ELIO ••• HEATING ELEMENT 700W - 230V 180X175X15 mm
Código fabricante / Manufacturer Code <b>IGS402P</b>	

Código fabricante / Manufacturer Code **IGS402P**

## TECNOINOX

	20163 Code <b>20163</b> ORIGINAL
	RESISTENCIA 3000W - 230V 474X285X54 mm
	FRY-TOP ••• HEATING ELEMENT 3000W - 230V 474X285X54 mm
Código fabricante / Manufacturer Code <b>00767</b>	

Código fabricante / Manufacturer Code **00767**

## ZANUSSI

	20163 Code <b>22070</b> ORIGINAL
	RESISTENCIA 1000W - 230V 600X54X82 mm
	FRY-TOP: HRS/E401, HRS/E411, HRS/E801, HRS/E811 ••• HEATING ELEMENT 1000W - 230V 600X54X82 mm
Código fabricante / Manufacturer Code <b>52919</b>	

Código fabricante / Manufacturer Code **52919**

## ZANUSSI

	20163 Code <b>22066</b> ORIGINAL
	RESISTENCIA 1250W - 230V 473X52X43 mm
	FRY-TOP: H700, R701 ••• HEATING ELEMENT 1250W - 230V 473X52X43 mm
Código fabricante / Manufacturer Code <b>53393</b>	

Código fabricante / Manufacturer Code **53393**

## ZANUSSI

	20163 Code <b>22067</b> ORIGINAL
	RESISTENCIA 1250W - 230V 482X54X55 mm
	FRY-TOP: PR700 ••• HEATING ELEMENT 1250W - 230V 482X54X55 mm
*CÓDIGO JUNTA / GASKET CODE 1248	
Código fabricante / Manufacturer Code <b>04649</b>	

Código fabricante / Manufacturer Code **04649**



# RESISTENCIAS PLANCHA/FRY-TOP / HOT PLATE/FRY-TOP HEATING ELEMENTS

## ZANUSSI

Referencia **22065** ORIGINAL  
Code

RESISTENCIA  
1300W - 230V  
473X80X55 mm

**FRY-TOP:** FTL35E, FTL70E, FTR35E, FTR70E, FTC35E, FTC70E

HEATING ELEMENT  
1300W - 230V  
473X80X55 mm

**FRY-TOP:** FTL35E, FTL70E, FTR35E, FTR70E, FTC35E, FTC70E



Código fabricante / Manufacturer Code **04918**

Referencia **22068** ORIGINAL  
Code

RESISTENCIA  
1500W - 230V  
484X90X50 mm

**FRY-TOP:** RR/E1CL, RR/E2CL

HEATING ELEMENT  
1500W - 230V  
484X90X50 mm

**FRY-TOP:** RR/E1CL, RR/E2CL



Código fabricante / Manufacturer Code **04671**

Referencia **22069** ORIGINAL  
Code

RESISTENCIA  
2000W - 230V  
595X41X40 mm

**FRY-TOP:** HRS/G802-HRS/G812

HEATING ELEMENT  
2000W - 230V  
595X41X40 mm

**FRY-TOP:** HRS/G802-HRS/G812



Código fabricante / Manufacturer Code **55998**

Referencia **22071** ORIGINAL  
Code

RESISTENCIA  
2000W - 230V  
570X86X87 mm

**FRY-TOP:** SERIE HD900

HEATING ELEMENT  
2000W - 230V  
570X86X84 mm

**FRY-TOP:** SERIES HD900



Código fabricante / Manufacturer Code **59401**

## ZANUSSI

Referencia **22072** ORIGINAL  
Code

RESISTENCIA  
2500W - 230V  
567X90X91 mm

**FRY-TOP:** HR/E413W, HR/E813, HR/E433W, HR/E833W

HEATING ELEMENT  
2500W - 230V  
567X90X91 mm

**FRY-TOP:** HR/E413W, HR/E813, HR/E433W, HR/E833W



Código fabricante / Manufacturer Code **06681**

## VARIOS

Referencia **89654** ORIGINAL  
Code

RESISTENCIA  
650W - 230V  
170X180 mm

**PLANCHA**

HEATING ELEMENT  
650W - 230V  
170X180 mm

**HOT PLATE**



Referencia **89653** ORIGINAL  
Code

RESISTENCIA  
800W - 230V  
170X180 mm

**PLANCHA**

HEATING ELEMENT  
800W - 230V  
170X180 mm

**HOT PLATE**



Referencia **85039** ORIGINAL  
Code

RESISTENCIA  
3000W - 230V  
420X125X20 mm

**PLANCHA**

HEATING ELEMENT  
3000W - 230V  
420X125X20 mm

**HOT PLATE**



# RESISTENCIAS SALAMANDRA / SALAMANDER GRILL HEATING ELEMENTS

## AMBACH

	Referencia Code	<b>20182</b> ORIGINAL
		RESISTENCIA 1000W - 230V 215X93 mm
	SALAMANDRA:	SE80
		HEATING ELEMENT 1000W - 230V 215X93 mm
	SALAMANDER GRILL:	SE80
Código fabricante / Manufacturer Code		6205403708

## BERTO'S

	Referencia Code	<b>19641</b> ORIGINAL
		RESISTENCIA 2300W - 230V 300X205X40 mm- ROSCA M4
	SALAMANDRA:	SA/E60, SA/E68E
		HEATING ELEMENT 2300W - 230V 300X205X40 mm / M4 THREAD
	SALAMANDER GRILL:	SA/E60, SA/E68E
Código fabricante / Manufacturer Code		27023000

## ANGELO PO

	Referencia Code	<b>22603</b> ORIGINAL
		RESISTENCIA 1300W - 230V 238X132X72 mm
	SALAMANDRA:	60SME
		HEATING ELEMENT 1300W - 230V 238X132X72 mm
	SALAMANDER GRILL:	60SME
Código fabricante / Manufacturer Code		3261140, 3261441, 3261580

## DIFRI

	Referencia Code	<b>87968</b> ORIGINAL
		RESISTENCIA 2000W - 230V
	SALAMANDRA	
		HEATING ELEMENT 2000W - 230V
	SALAMANDER GRILL	
Código fabricante / Manufacturer Code		26962007

## BECKERS

	Referencia Code	<b>85087</b> ORIGINAL
		RESISTENCIA 2000W - 230V 208X462 mm
	SALAMANDRA:	SA936
		HEATING ELEMENT 2000W - 230V 208X462 mm
	SALAMANDER GRILL:	SA936
Código fabricante / Manufacturer Code		---

## EMMEPI

	Referencia Code	<b>20182</b> ORIGINAL
		RESISTENCIA 1000W - 230V 220X95 mm
	SALAMANDRA	
		HEATING ELEMENT 1000W - 230V 220X95 mm
	SALAMANDER GRILL	
Código fabricante / Manufacturer Code		E12110001

## BERTO'S

	Referencia Code	<b>19640</b> ORIGINAL
		RESISTENCIA 1600W - 230V 295X205X45 mm- ROSCA M5
	SALAMANDRA:	SA/E60, SA/E68M
		HEATING ELEMENT 1600W - 230V 295X205X45 mm / M5 THREAD
	SALAMANDER GRILL:	SA/E60, SA/E68M
Código fabricante / Manufacturer Code		27022300

## EMMEPI

	Referencia Code	<b>20179</b> ORIGINAL
		RESISTENCIA 2000W - 230V 257X230 mm
	SALAMANDRA	
		HEATING ELEMENT 2000W - 230V 257X230 mm
	SALAMANDER GRILL	
Código fabricante / Manufacturer Code		8C0296

# RESISTENCIAS SALAMANDRA / SALAMANDER GRILL HEATING ELEMENTS

## EMMEPI

Referencia Code **20175** ORIGINAL



RESISTENCIA  
2000W - 230V  
255X230 mm

SALAMANDRA



HEATING ELEMENT  
2000W - 230V  
255X230 mm

SALAMANDER GRILL

Código fabricante / Manufacturer Code **8C0222**

Referencia Code **33925** ORIGINAL



RESISTENCIA  
3300W - 230V  
240X380 mm

SALAMANDRA: 520



HEATING ELEMENT  
3300W - 230V  
240X380 mm

SALAMANDER GRILL: 520

Código fabricante / Manufacturer Code **808459**

## FIAMMA

Referencia Code **90522** ORIGINAL



RESISTENCIA SUPERIOR  
1350W - 230V  
200X320X30 mm

SALAMANDRA: GR6



UPPER HEATING ELEMENT  
1350W - 230V  
200X320X30 mm

SALAMANDER GRILL: GR6

Código fabricante / Manufacturer Code **4.0.069.0045**

Referencia Code **90521** ORIGINAL



RESISTENCIA INFERIOR  
1900W - 230V  
200X300X26 mm

SALAMANDRA: GR6



LOWER HEATING ELEMENT  
1900W - 230V  
200X300X26 mm

SALAMANDER GRILL: GR6

Código fabricante / Manufacturer Code **4.0.069.0045**

## FRANKE

Referencia Code **51228** ORIGINAL



RESISTENCIA  
2300W - 230V  
315X190 mm

SALAMANDRA



HEATING ELEMENT  
2300W - 230V  
315X190 mm

SALAMANDER GRILL

Código fabricante / Manufacturer Code **5356201**

## GAYC

Referencia Code **596** ORIGINAL



RESISTENCIA  
380W - 230V  
L = 380 mm

SALAMANDRA



HEATING ELEMENT  
380W - 230V  
L = 380 mm

SALAMANDER GRILL

Código fabricante / Manufacturer Code **112420120**



Referencia Code **9536** ORIGINAL

RESISTENCIA  
1150W - 230V  
200X370 mm

SALAMANDRA



HEATING ELEMENT  
1150W - 230V  
200X370 mm

SALAMANDER GRILL

Código fabricante / Manufacturer Code **12420100**

\*CÓDIGO JUNTA / GASKET CODE  
1368

## GIGA

Referencia Code **19640** ORIGINAL



RESISTENCIA  
1600W - 230V  
295X205X45 mm - ROSCA M5

SALAMANDRA: S205, S600E, S680E



HEATING ELEMENT  
1600W - 230V  
295X205X45 mm - M5 THREAD

SALAMANDER GRILL: S205, S600E, S680E

Código fabricante / Manufacturer Code **X47800**

# RESISTENCIAS SALAMANDRA / SALAMANDER GRILL HEATING ELEMENTS

## GIGA

	Referencia Code	<b>19641</b> ORIGINAL
	RESISTENCIA 2300W - 230V 300X205X40 mm / ROSCA M4	
	SALAMANDRA: S205, S600E, S680E •••	
	HEATING ELEMENT 2300W - 230V 300X205X40 mm / M4 THREAD	
SALAMANDER GRILL: S205, S600E, S680E		
Código fabricante / Manufacturer Code ---		

	Referencia Code	<b>19639</b> ORIGINAL
	RESISTENCIA 2500W - 230V 223X310 mm / ROSCA 1/4"	
	SALAMANDRA: S105 •••	
	HEATING ELEMENT 2500W - 230V 223X310 mm / 1/4" THREAD	
SALAMANDER GRILL: S105		
Código fabricante / Manufacturer Code X48900		

## LOTUS

	Referencia Code	<b>19770</b> ORIGINAL
	RESISTENCIA 2000W - 230V 290X216 mm / ROSCA M12X1	
	SALAMANDRA: SA-400, SA- 600 •••	
	HEATING ELEMENT 2000W - 230V 295X220 mm / M12X1 THREAD	
SALAMANDER GRILL: SA-400, SA-600		
Código fabricante / Manufacturer Code 53.7.0206.00		

	Referencia Code	<b>19771</b> ORIGINAL
	RESISTENCIA 2000W - 230V 255X205 mm / ROSCA 1/4"	
	SALAMANDRA: SL-600 •••	
	HEATING ELEMENT 2000W - 230V 255X205 mm / 1/4" THREAD	
SALAMANDER GRILL: SA-600		
Código fabricante / Manufacturer Code 53.7.0205.00		

\*CÓDIGO JUNTA / GASKET CODE  
1248

## MARENO

	Referencia Code	<b>22607</b> ORIGINAL
	RESISTENCIA 2000W - 230V 435X170 mm	
	SALAMANDRA: SME62M •••	
	HEATING ELEMENT 2000W - 230V 435X170 mm	
SALAMANDER GRILL: SME62M		
Código fabricante / Manufacturer Code 1037041200, 1037316100		

	Referencia Code	<b>22608</b> ORIGINAL
	RESISTENCIA 3000W - 230V 425X165 mm	
	SALAMANDRA: SME63M •••	
	HEATING ELEMENT 3000W - 230V 425X165 mm	
SALAMANDER GRILL: SME63M		
Código fabricante / Manufacturer Code 1037042213, 1037316200		

	Referencia Code	<b>22609</b> ORIGINAL
	RESISTENCIA 3500W - 230V 525X167 mm	
	SALAMANDRA: SME70M •••	
	HEATING ELEMENT 3500W - 230V 525X167 mm	
SALAMANDER GRILL: SME70M		
Código fabricante / Manufacturer Code 1037316300		

## MODULAR

	Referencia Code	<b>20040</b> ORIGINAL
	RESISTENCIA 2000W - 230V 225X230 mm	
	SALAMANDRA •••	
	HEATING ELEMENT 2000W - 230V 225X230 mm	
SALAMANDER GRILL		
Código fabricante / Manufacturer Code 665.027.00		

# RESISTENCIAS SALAMANDRA / SALAMANDER GRILL HEATING ELEMENTS

## MODULAR

	Referencia Code	<b>20179</b> ORIGINAL
		RESISTENCIA 2000W - 230V 225X230 mm
	SALAMANDRA	• • •
	HEATING ELEMENT	2000W - 230V 225X230 mm
	SALAMANDER GRILL	
Código fabricante / Manufacturer Code		665.026.00

## SAMMIC

	Referencia Code	<b>89566</b> ORIGINAL
		RESISTENCIA 2000W - 230V 230X240 mm
	SALAMANDRA:	SG-651 • • •
	HEATING ELEMENT	2000W - 230V 230X240 mm
	SALAMANDER GRILL:	SG-651
Código fabricante / Manufacturer Code		6131548

## REPAGAS

	Referencia Code	<b>24611</b> STANDARD
		RESISTENCIA 1300W - 230V 300X130x70 mm
	SALAMANDRA	• • •
	HEATING ELEMENT	1300W - 230V 300X130X70 mm
	SALAMANDER GRILL	
Código fabricante / Manufacturer Code		32400014

## SIRMAN

	Referencia Code	<b>89769</b> ORIGINAL
		RESISTENCIA 1700W - 230V 235X200 mm
	SALAMANDRA:	PRO1/1G, PRO182G • • •
	HEATING ELEMENT	1700W - 230V 235X200 mm
	SALAMANDER GRILL:	PRO1/1G, PRO182G
Código fabricante / Manufacturer Code		52565010

\*CÓDIGO JUNTA / GASKET CODE  
1248

## 88555 ORIGINAL

	Referencia Code	<b>88555</b> ORIGINAL
		RESISTENCIA 2500W - 230V
	SALAMANDRA:	CE650 • • •
	HEATING ELEMENT	2500W - 230V
	SALAMANDER GRILL:	CE650
Código fabricante / Manufacturer Code		27800008

## TECNOINOX

	Referencia Code	<b>20182</b> ORIGINAL
		RESISTENCIA 1000W - 230V 215X93 mm
	SALAMANDRA	• • •
	HEATING ELEMENT	1000W - 230V 215X93 mm
	SALAMANDER GRILL	
Código fabricante / Manufacturer Code		03708

## SAMMIC

	Referencia Code	<b>16549</b> ORIGINAL
		RESISTENCIA 1750W - 230V
	SALAMANDRA	• • •
	HEATING ELEMENT	1750W - 230V
	SALAMANDER GRILL	
Código fabricante / Manufacturer Code		6503600

## 20175 ORIGINAL

	Referencia Code	<b>20175</b> ORIGINAL
		RESISTENCIA 2000W - 230V 230X255 mm
	SALAMANDRA	• • •
	HEATING ELEMENT	2000W - 230V 230X255 mm
	SALAMANDER GRILL	
Código fabricante / Manufacturer Code		00109

# RESISTENCIAS SALAMANDRA / SALAMANDER GRILL HEATING ELEMENTS

## TECNOINOX

	Referencia Code	<b>20040</b> ORIGINAL
		RESISTENCIA 2000W - 230V 225X283 mm
	SALAMANDRA: SE40	• • •
		HEATING ELEMENT 2000W - 230V 225X230 mm
SALAMANDER GRILL: SE40		
Código fabricante / Manufacturer Code		03804

	Referencia Code	<b>20179</b> ORIGINAL
		RESISTENCIA 2000W - 230V 257X230 mm
	SALAMANDRA: SE60	• • •
		HEATING ELEMENT 2000W - 230V 257X230 mm
SALAMANDER GRILL: SE60		
Código fabricante / Manufacturer Code		RC00003706

	Referencia Code	<b>20180</b> ORIGINAL
		RESISTENCIA 2000W - 400V 228X230 mm
	SALAMANDRA: SE60	• • •
		HEATING ELEMENT 2000W - 230V 228X230 mm
SALAMANDER GRILL: SE60		
Código fabricante / Manufacturer Code		---

## ZANUSSI

	Referencia Code	<b>20182</b> ORIGINAL
		RESISTENCIA 1000W - 230V 215X93 mm
	SALAMANDRA	• • •
		HEATING ELEMENT 1000W - 230V 215X93 mm
SALAMANDER GRILL		
Código fabricante / Manufacturer Code		03014

## ZANUSSI

	Referencia Code	<b>22604</b> ORIGINAL
		RESISTENCIA 1900W - 230V 245X230 mm
	SALAMANDRA: SL-E851, SL-E901	• • •
		HEATING ELEMENT 1900W - 230V 245X230 mm
SALAMANDER GRILL: SL-E851, SL-E901		
Código fabricante / Manufacturer Code		56783

	Referencia Code	<b>22605</b> ORIGINAL
		RESISTENCIA 2000W - 230V 240X333 mm
	SALAMANDRA	• • •
		HEATING ELEMENT 2000W - 230V 240X333 mm
SALAMANDER GRILL		
Código fabricante / Manufacturer Code		56782

	Referencia Code	<b>20179</b> ORIGINAL
		RESISTENCIA 2000W - 230V 257X230 mm
	SALAMANDRA: SE60	• • •
		HEATING ELEMENT 2000W - 230V 257X230 mm
SALAMANDER GRILL: SE60		
Código fabricante / Manufacturer Code		003012

	Referencia Code	<b>20040</b> ORIGINAL
		RESISTENCIA 2000W - 230V 225X230 mm
	SALAMANDRA	• • •
		HEATING ELEMENT 2000W - 230V 225X230 mm
SALAMANDER GRILL		
Código fabricante / Manufacturer Code		003016

	Referencia Code	<b>22606</b> ORIGINAL
		RESISTENCIA 3000W - 230V 357X226 mm
	SALAMANDRA	• • •
		HEATING ELEMENT 3000W - 230V 357X226 mm
SALAMANDER GRILL		
Código fabricante / Manufacturer Code		052836

# RESISTENCIAS SARTÉN BASCULANTE / TILTING BRATT PAN H. ELEMENTS

## AMBACH

	Referencia Code	<b>19449</b> ORIGINAL
		RESISTENCIA 1500W - 230V 530X45X90 mm
		<b>SARTÉN BASCULANTE:</b> EKB90, SERIE 700, SERIE 900
		HEATING ELEMENT 1500W - 230V 530X45X90 mm
		<b>TILTING BRATT PAN:</b> EKB90, SERIES 700, SERIES 900
Código fabricante / Manufacturer Code		5060814355

	Referencia Code	<b>19801</b> ORIGINAL
		RESISTENCIA 1500W - 400V 527X53X94 mm
		<b>SARTÉN BASCULANTE:</b> EKBD125
		HEATING ELEMENT 1500W - 400V 527X53X94 mm
		<b>TILTING BRATT PAN:</b> EKBD125
Código fabricante / Manufacturer Code		5060817107, 5060818231

	Referencia Code	<b>19445</b> ORIGINAL
		RESISTENCIA 7500W - 230V 480X440X30 mm
		<b>SARTÉN BASCULANTE:</b> TPE70, KBHE70, KME50
		HEATING ELEMENT 7500W - 230V 480X440X30 mm
		<b>TILTING BRATT PAN:</b> TPE70, KBHE70, KME50
Código fabricante / Manufacturer Code		5060807220

	Referencia Code	<b>19446</b> ORIGINAL
		RESISTENCIA CON CABLES 9000W - 230V 520X600X35 mm
		<b>SARTÉN BASCULANTE:</b> EKM50
		HEATING ELEMENT WITH WIRES 9000W - 230V 520X600X35 mm
		<b>TILTING BRATT PAN:</b> EKM50
Código fabricante / Manufacturer Code		5060807221

## AMBACH

	Referencia Code	<b>19447</b> ORIGINAL
		RESISTENCIA 9000W - 230V 426X410X33 mm
		<b>SARTÉN BASCULANTE:</b> TPE80
		HEATING ELEMENT 9000W - 230V 426X410X33 mm
		<b>TILTING BRATT PAN:</b> TPE80
Código fabricante / Manufacturer Code		5060808751

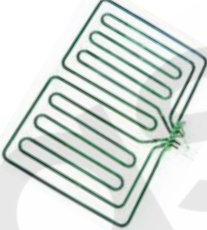
	Referencia Code	<b>19448</b> ORIGINAL
		RESISTENCIA 12000W - 230V 475X700X33 mm
		<b>SARTÉN BASCULANTE:</b> KHE90, KME90
		HEATING ELEMENT 12000W - 230V 475X700X33 mm
		<b>TILTING BRATT PAN:</b> KHE90, KME90
Código fabricante / Manufacturer Code		5060803648

## BARON

	Referencia Code	<b>19435</b> ORIGINAL
		RESISTENCIA 1200W - 230V 292X86X20 mm - ROSCA 1/4"
		<b>SARTÉN BASCULANTE:</b> SERIE 700
		HEATING ELEMENT 1200W - 230V 292X86X20 mm - 1/4" THREAD
		<b>TILTING BRATT PAN:</b> SERIE 700
Código fabricante / Manufacturer Code		826620090

	Referencia Code	<b>19436</b> ORIGINAL
		RESISTENCIA 2000W - 230V 290X143X26 mm - ROSCA 1/4"
		<b>SARTÉN BASCULANTE:</b> SERIE 900
		HEATING ELEMENT 2000W - 230V 290X143X26 mm - 1/4" THREAD
		<b>TILTING BRATT PAN:</b> SERIE 900
Código fabricante / Manufacturer Code		826620120

# RESISTENCIAS SARTÉN BASCULANTE / TILTING BRATT PAN H. ELEMENTS

## EMMEPI

Referencia  
Code **19534** ORIGINAL

RESISTENCIA  
1200W - 230V  
295X105X32 mm

SARTÉN BASCULANTE

HEATING ELEMENT  
1200W - 230V  
295X105X32 mm

TILTING BRAT PAN



Código fabricante / Manufacturer Code

C00650



DESCÁRGATE  
NUESTRO  
CATÁLOGO  
DE BARISTA

DOWNLOAD  
OUR BARISTA  
CATALOGUE

\* FORMATO PDF / PDF FILE

# RESISTENCIAS TOSTADOR DE PAN / BREAD TOASTER HEATING ELEMENTS

## BECKERS

Referencia  
Code **89807** ORIGINAL

RESISTENCIA  
425W - 230V  
L = 330 mm

TOSTADOR DE PAN

HEATING ELEMENT  
425W - 230V  
L = 330 mm

BREAD TOASTER



Código fabricante / Manufacturer Code

---

## DOSILET

Referencia  
Code **13102** ORIGINAL

RESISTENCIA  
475W - 230V  
L = 280 mm

TOSTADOR DE PAN

HEATING ELEMENT  
475W - 230V  
L = 280 mm

BREAD TOASTER



Código fabricante / Manufacturer Code

91028

## DOSILET

Referencia  
Code **14218** ORIGINAL

RESISTENCIA  
333W - 230V  
Ø10 mm - L = 350

TOSTADOR DE PAN: TR1003, TR1004

HEATING ELEMENT  
333W - 230V  
Ø10 mm - L = 350

BREAD TOASTER: TR1003, TR1004



Código fabricante / Manufacturer Code

91224

Referencia  
Code **5515** ORIGINAL

RESISTENCIA  
600W - 230V  
L = 530 mm

TOSTADOR DE PAN

HEATING ELEMENT  
600W - 230V  
L = 530 mm

BREAD TOASTER



Código fabricante / Manufacturer Code

---



# RESISTENCIAS TOSTADOR DE PAN / BREAD TOASTER HEATING ELEMENTS

## DOSILET



\*CÓDIGO JUNTA / GASKET CODE  
1248

Referencia **24296** ORIGINAL  
Code

RESISTENCIA  
1000W - 230V  
350X75 mm

TOSTADOR DE PAN: TT4000, TT0001,  
TT6000

• • •

HEATING ELEMENT  
1000W - 230V  
350X75 mm

BREAD TOASTER: TT4000, TT0001, TT6000

Código fabricante / Manufacturer Code **91022**

## EDESA



Código fabricante / Manufacturer Code

Referencia **84806** ORIGINAL  
Code

RESISTENCIA  
260W - 230V  
L = 375 mm

TOSTADOR DE PAN: TCP-40

• • •

HEATING ELEMENT  
260W - 230V  
L = 375 mm

BREAD TOASTER: TCP-40

**K009B43303**

## FRANKE



\*CÓDIGO JUNTA / GASKET CODE  
1248

Referencia **32605** STANDARD  
Code

RESISTENCIA  
1100W - 230V  
380X170X200 mm

TOSTADOR DE PAN

• • •

HEATING ELEMENT  
1100W - 230V  
380X170X200 mm

BREAD TOASTER



Código fabricante / Manufacturer Code

Referencia **31073** ORIGINAL  
Code

RESISTENCIA IZQUIERDA  
2000W - 230V  
250X210X120 mm

TOSTADOR DE PAN

• • •

LEFT HEATING ELEMENT  
2000W - 230V  
250X210X120 mm

BREAD TOASTER

**279801**



\*CÓDIGO JUNTA / GASKET CODE  
2106

Referencia **16859** ORIGINAL  
Code

RESISTENCIA  
1400W - 230V  
300X110 mm

TOSTADOR DE PAN

• • •

HEATING ELEMENT  
1400W - 230V  
300X110 mm

BREAD TOASTER

Código fabricante / Manufacturer Code **91029, 400007115**



Código fabricante / Manufacturer Code

Referencia **31074** ORIGINAL  
Code

RESISTENCIA DERECHA  
2000W - 230V  
250X210X120 mm

TOSTADOR DE PAN

• • •

RIGHT HEATING ELEMENT  
2000W - 230V  
250X210X120 mm

BREAD TOASTER

**279802**



Código fabricante / Manufacturer Code

Referencia **8642** ORIGINAL  
Code

RESISTENCIA  
1500W - 230V  
190X370 mm

TOSTADOR DE PAN

• • •

HEATING ELEMENT  
1500W - 230V  
190X370 mm

BREAD TOASTER

**91003**

## GAYC



\*CÓDIGO JUNTA / GASKET CODE  
1248

Código fabricante / Manufacturer Code

Referencia **10425** ORIGINAL  
Code

RESISTENCIA  
1150W - 380V  
L = 175 mm

TOSTADOR DE PAN

• • •

HEATING ELEMENT  
1150W - 380V  
250X210X120 mm

BREAD TOASTER

**12420120**

# RESISTENCIAS TOSTADOR DE PAN / BREAD TOASTER HEATING ELEMENTS

## GAYC



Referencia  
Code **89561** ORIGINAL

RESISTENCIA  
1150W - 230V  
370X200 mm

TOSTADOR DE PAN: GY02

HEATING ELEMENT  
1150W - 230V  
370X200 mm

BREAD TOASTER: GY02

Código fabricante / Manufacturer Code 12507020

## MIRROR



Referencia  
Code **51455** ORIGINAL

RESISTENCIA  
1700W - 230V

TOSTADOR DE PAN: TCP-40

HEATING ELEMENT  
1700W - 230V

BREAD TOASTER: TCP-40

Código fabricante / Manufacturer Code 973.010

## GINSOSA



Referencia  
Code **24715** ORIGINAL

RESISTENCIA  
500W - 230V  
240X90 mm

TOSTADOR DE PAN: TT22

HEATING ELEMENT  
500W - 230V  
240X90 mm

BREAD TOASTER: TT22

Código fabricante / Manufacturer Code G005481

## PANAROLA



Referencia  
Code **9538** ORIGINAL

RESISTENCIA  
600W - 230V  
L = 350 mm - CONEXION TORNILLO

TOSTADOR DE PAN: TCP-40

HEATING ELEMENT  
600W - 230V  
L = 350 mm - SCREW CONNECTION

BREAD TOASTER: TCP-40

Código fabricante / Manufacturer Code 213005

## INNOVA



Referencia  
Code **23199** ORIGINAL

RESISTENCIA  
500W - 110V  
L = 355 mm

TOSTADOR DE PAN

HEATING ELEMENT  
500W - 110V  
L = 355 mm

BREAD TOASTER

Código fabricante / Manufacturer Code T01110

## ROLLER GRILL



Referencia  
Code **49014** ORIGINAL

RESISTENCIA  
500W - 230V  
Ø10 mm - L = 365

TOSTADOR DE PAN: BAR1000, BAR2000

HEATING ELEMENT  
500W - 230V  
Ø10 mm - L = 365

BREAD TOASTER: BAR1000, BAR2000

Código fabricante / Manufacturer Code D04022

## MASAMAR



Referencia  
Code **89644** ORIGINAL

RESISTENCIA  
500W - 230V

TOSTADOR DE PAN: TT22

HEATING ELEMENT  
500W - 110V

BREAD TOASTER: TT22

Código fabricante / Manufacturer Code RTT22RE

## SAMMIC



Referencia  
Code **28320** ORIGINAL

RESISTENCIA  
600W - 230V  
L = 395 mm

TOSTADOR DE PAN: 21TP

HEATING ELEMENT  
600W - 230V  
L = 395 mm

BREAD TOASTER: 21TP

Código fabricante / Manufacturer Code 6100403

# RESISTENCIAS TOSTADOR DE PAN / BREAD TOASTER HEATING ELEMENTS

## SAMMIC



Referencia Code **8643** STANDARD

RESISTENCIA  
1150W - 230V  
215X200 mm

TOSTADOR DE PAN

HEATING ELEMENT  
1150W - 230V  
215X200 mm

BREAD TOASTER

Referencia Code **80360** ORIGINAL



RESISTENCIA BLINDADA  
1200W - 230V  
255X160 mm

TOSTADOR DE PAN: ST-250

REINFORCED HEATING ELEMENT  
1200W - 230V  
255X160 mm

BREAD TOASTER: ST-250

Código fabricante / Manufacturer Code **6110650**

Referencia Code **84586** ORIGINAL



RESISTENCIA  
2800W - 230V

TOSTADOR DE PAN: STT

REINFORCED HEATING ELEMENT  
2800W - 230V

BREAD TOASTER: STT

Código fabricante / Manufacturer Code **6503110**

## SIRMAN



Referencia Code **89253**

TUBO RESISTENCIA

TOSTADOR DE PAN: ROLLER LONG VV

HEATING ELEMENT PIPE

BREAD TOASTER: ROLLER LONG VV

Código fabricante / Manufacturer Code **1B3506900**

## SIRMAN



Referencia Code **89254** ORIGINAL

RESISTENCIA  
380W - 230V  
Ø12 mm - L = 255

TOSTADOR DE PAN: ROLLER LONG VV,  
12Q, 6Q, 4Q

HEATING ELEMENT  
380W - 230V  
Ø12 mm - L = 255

BREAD TOASTER: ROLLER LONG VV, 12Q,  
6Q, 4Q

Código fabricante / Manufacturer Code **1B5206910**

## VARIOS



Referencia Code **9533** STANDARD

RESISTENCIA  
600W - 230V  
L = 350 mm  
CONEXIÓN FASTON

TOSTADOR DE PAN

HEATING ELEMENT  
600W - 230V  
L = 350 mm  
FASTON CONNECTION

BREAD TOASTER

Referencia Code **9534** STANDARD



RESISTENCIA  
600W - 230V  
L = 370 mm  
CONEXIÓN FASTON

TOSTADOR DE PAN

HEATING ELEMENT  
600W - 230V  
L = 370 mm  
FASTON CONNECTION

BREAD TOASTER

Referencia Code **9535** STANDARD



RESISTENCIA  
600W - 230V  
L = 390 mm  
CONEXIÓN FASTON

TOSTADOR DE PAN

HEATING ELEMENT  
600W - 230V  
L = 390 mm  
FASTON CONNECTION

BREAD TOASTER

# RESISTENCIAS TOSTADOR DE PAN / BREAD TOASTER HEATING ELEMENTS

VARIOS		VARIOS	
	<b>Referencia Code</b> <b>10064</b> STANDARD		<b>Referencia Code</b> <b>9532</b> STANDARD
	RESISTENCIA 600W - 230V L = 400 mm CONEXIÓN FASTON  <b>TOSTADOR DE PAN</b> HEATING ELEMENT 600W - 230V L = 400 mm FASTON CONNECTION  <b>BREAD TOASTER</b>		RESISTENCIA 750W - 230V L = 600 mm CONEXIÓN FASTON  <b>TOSTADOR DE PAN</b> HEATING ELEMENT 750W - 230V L = 600 mm FASTON CONNECTION  <b>BREAD TOASTER</b>
	<b>Referencia Code</b> <b>33877</b> STANDARD		<b>Referencia Code</b> <b>26956</b> STANDARD
	RESISTENCIA 600W - 230V L = 320 mm CONEXIÓN FASTON  <b>TOSTADOR DE PAN</b> HEATING ELEMENT 600W - 230V L = 320 mm FASTON CONNECTION  <b>BREAD TOASTER</b>		RESISTENCIA 750W - 230V L = 600 mm  <b>TOSTADOR DE PAN</b> HEATING ELEMENT 750W - 230V L = 600 mm  <b>BREAD TOASTER</b>
	<b>Referencia Code</b> <b>9531</b> STANDARD		<b>Referencia Code</b> <b>85439</b> STANDARD
	RESISTENCIA 750W - 230V L = 450 mm CONEXIÓN FASTON  <b>TOSTADOR DE PAN</b> HEATING ELEMENT 750W - 230V L = 450 mm FASTON CONNECTION  <b>BREAD TOASTER</b>		RESISTENCIA 750W - 230V L = 516 mm  <b>TOSTADOR DE PAN</b> HEATING ELEMENT 750W - 230V L = 516 mm  <b>BREAD TOASTER</b>





# eunasa**blog**

<http://www.eunasa.com/blog>



# RESISTENCIAS MAQUINARIA VARIA / MULTIPLE EQUIPMENT H. ELEMENTS

VARIOS		VARIOS			
	Referencia Code <b>50401</b> STANDARD		Referencia Code <b>33750</b> STANDARD		
	RESISTENCIA CERÁMICA 125W - 230V 122X62 mm ... CERAMIC HEATING ELEMENT 125W - 230V 122X62 mm		RESISTENCIA CERÁMICA 300W - 230V 120X60 mm ... CERAMIC HEATING ELEMENT 300W - 230V 120X60 mm		
	Referencia Code <b>50402</b> STANDARD		Referencia Code <b>50397</b> STANDARD		
	RESISTENCIA CERÁMICA 150W - 230V 122X62 mm ... CERAMIC HEATING ELEMENT 150W - 230V 122X62 mm		RESISTENCIA CERÁMICA 300W - 230V 240X60 mm ... CERAMIC HEATING ELEMENT 300W - 230V 240X60 mm		
	Referencia Code <b>50403</b> STANDARD		Referencia Code <b>50405</b> STANDARD		
	RESISTENCIA CERÁMICA 200W - 230V 122X62 mm ... CERAMIC HEATING ELEMENT 200W - 230V 122X62 mm		RESISTENCIA CERÁMICA 325W - 230V 122X62 mm ... CERAMIC HEATING ELEMENT 325W - 230V 122X62 mm		
	Referencia Code <b>50404</b> STANDARD		Referencia Code <b>50398</b> STANDARD		
	RESISTENCIA CERÁMICA 250W - 230V 122X62 mm ... CERAMIC HEATING ELEMENT 250W - 230V 122X62 mm		RESISTENCIA CERÁMICA 400W - 230V 245X60X35 mm ... CERAMIC HEATING ELEMENT 400W - 230V 245X60X35 mm		
	Referencia Code <b>50655</b> STANDARD	*VER TABLA / SEE NEXT TABLE			
	RESISTENCIA CERÁMICA 250W - 230V 245X60 mm ... CERAMIC HEATING ELEMENT 250W - 230V 245X60 mm	VÁLIDO PARA: / SUITABLE FOR:			
		FABRICANTE MANUFACTURER	CÓDIGO / CODE	MÁQUINA / MACHINE	MODELOS / MODELS
		EMMEPI	808142	---	---
		GIORIK	6001124	---	---
		MARENO	4344500, 4344501	---	---
		ZANUSSI	058144	---	---

# RESISTENCIAS MAQUINARIA VARIA / MULTIPLE EQUIPMENT H. ELEMENTS

## VARIOS

Referencia Code **50406** STANDARD



RESISTENCIA CERÁMICA  
400W - 230V  
122X62 mm

...

CERAMIC HEATING ELEMENT  
400W - 230V  
122X62 mm

Referencia Code **23819** STANDARD



RESISTENCIA CERÁMICA  
500W - 230V  
125X60X35 mm

...

CERAMIC HEATING ELEMENT  
500W - 230V  
125X60X35 mm

Referencia Code **25863** STANDARD



RESISTENCIA CERÁMICA  
500W - 230V  
240X58 mm

...

CERAMIC HEATING ELEMENT  
500W - 230V  
240X58 mm

Referencia Code **33752** STANDARD



RESISTENCIA CERÁMICA  
500W - 230V  
245X62 mm

...

CERAMIC HEATING ELEMENT  
500W - 230V  
245X62 mm

## VARIOS

Referencia Code **50399** STANDARD



RESISTENCIA CERÁMICA  
650W - 230V  
245X60 mm

...

CERAMIC HEATING ELEMENT  
650W - 230V  
245X60 mm

\*VER TABLA / SEE NEXT TABLE

VÁLIDO PARA: / SUITABLE FOR:

FABRICANTE MANUFACTURER	CÓDIGO / CODE	MÁQUINA / MACHINE	MODELOS / MODELS
BERTO'S	22016100	MANT. FRITOS/CHIP SCUTTLE	---
GICO	51012300650	---	---
GIGA	X48000	MANT. FRITOS/CHIP SCUTTLE	SKP40E
LOTUS	537015200	MANT. FRITOS/CHIP SCUTTLE	BS74EM
SILKO	0109051	MANT. FRITOS/CHIP SCUTTLE	CS654
TECNOINOX	RC00288000	---	---
ZANUSSI	004898	---	---

Referencia Code **50400** STANDARD



RESISTENCIA CERÁMICA  
750W - 230V  
245X62 mm

...

CERAMIC HEATING ELEMENT  
750W - 230V  
245X62 mm

Referencia Code **33753** STANDARD



RESISTENCIA CERÁMICA  
800W - 230V  
240X60 mm

...

CERAMIC HEATING ELEMENT  
800W - 230V  
240X60 mm

# RESISTENCIAS MAQUINARIA VARIA / MULTIPLE EQUIPMENT H. ELEMENTS

## VARIOS

Referencia Code **23345** STANDARD



RESISTENCIA CERÁMICA  
1000W - 230V  
245X60X35 mm

...

CERAMIC HEATING ELEMENT  
1000W - 230V  
245X60X35 mm

\*VER TABLA / SEE NEXT TABLE

## VARIOS

Referencia Code **10452** STANDARD



RESISTENCIA CREMA CATALANA  
900W - 230V  
Ø110 mm

...

CARAMELIZER HEATING ELEMENT  
900W - 230V  
Ø110 mm

### VÁLIDO PARA: / SUITABLE FOR:

FABRICANTE MANUFACTURER	CÓDIGO / CODE	MÁQUINA / MACHINE	MODELOS / MODELS
BARON	826620170	MANT. FRITOS/CHIP SCUTTLE	SERIES 600
MBM	RTC0600117	MANT. FRITOS/CHIP SCUTTLE	ECC46
MODULAR	665.010.00	MANT. FRITOS/CHIP SCUTTLE	60/30 SPE, 65/40SPE, 70/40 SPE, 90/40 SPE
POLYDOR	---	---	GL SERIES
POTIS	PT0212	ASADOR GYROS/GYROS GRILL	EH
TECNOINOX	RC01098000	MANT. FRITOS/CHIP SCUTTLE	SP35E7

Referencia Code **24068** STANDARD



RESISTENCIA CREMA CATALANA  
900W - 230V  
Ø100 mm

...

CARAMELIZER HEATING ELEMENT  
900W - 230V  
Ø100 mm

Referencia Code **33751** STANDARD



RESISTENCIA CERÁMICA  
1000W - 230V  
240X59 mm

...

CERAMIC HEATING ELEMENT  
1000W - 230V  
240X59 mm

Referencia Code **87025** STANDARD



RESISTENCIA CREMA CATALANA  
1000W - 230V  
Ø120 mm

...

CARAMELIZER HEATING ELEMENT  
1000W - 230V  
Ø120 mm

Referencia Code **14393** STANDARD



RESISTENCIA CREMA CATALANA  
600W - 230V  
Ø90 mm

...

CARAMELIZER HEATING ELEMENT  
600W - 230V  
Ø90 mm

Referencia Code **87026** STANDARD



RESISTENCIA CREMA CATALANA  
1200W - 230V  
240X80 mm

...

CARAMELIZER HEATING ELEMENT  
1200W - 230V  
240X80 mm

# RESISTENCIAS MAQUINARIA VARIA / MULTIPLE EQUIPMENT H. ELEMENTS

## VARIOS

Referencia  
Code **87027** STANDARD



RESISTENCIA CREMA CATALANA  
2000W - 230V  
240X120 mm

• • •

CARAMELIZER HEATING ELEMENT  
2000W - 230V  
240X120 mm

Referencia  
Code **27927** STANDARD



PALA CREMA CATALANA  
Ø100 mm

• • •

ROUND CARAMELIZER SHOVEL  
Ø100 mm

Referencia  
Code **27740** STANDARD



CALENTADOR ELÉCTRICO  
CHAFING-DISH  
500W - 230V  
CON REGULADOR

• • •

CHAFING-DISH  
ELECTRIC HEATER  
WITH REGULATOR  
500W - 230V

Referencia  
Code **95341** STANDARD



CALENTADOR ELÉCTRICO  
CHAFING-DISH  
700W - 230V  
250X200 mm  
TEMPERATURA 92°C

• • •

CHAFING-DISH  
ELECTRIC HEATER  
700W - 230V  
250X200 mm  
TEMPERATURE 92°C

## VARIOS

Referencia  
Code **95443** STANDARD



CALENTADOR ELÉCTRICO  
CHAFING-DISH  
700W - 230V  
250X200 mm  
CON REGULADOR

• • •

CHAFING-DISH  
ELECTRIC HEATER  
WITH REGULATOR  
700W - 230V  
250X200 mm

## ACCESORIOS RESISTENCIAS HEATING ELEMENT ACCESSORIES

## VARIOS

Referencia  
Code **19929** STANDARD



TUERCA RESISTENCIA  
FREIDORA  
M54X1.5

• • •

FRYER  
HEATING ELEMENT NUT  
M54X1.5

Referencia  
Code **85916** STANDARD

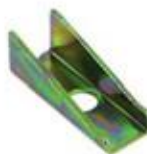

GRAPA SUJECIÓN  
RESISTENCIA  
21X10X10 mm  
AGUJERO Ø6,5 mm

• • •

HEATING ELEMENT  
TENSION CLAMP  
21X10X10 mm  
Ø HOLE 6.5 mm