

TWO WAY INLET VALVE

TIPO ED 180/88

ED 180/88

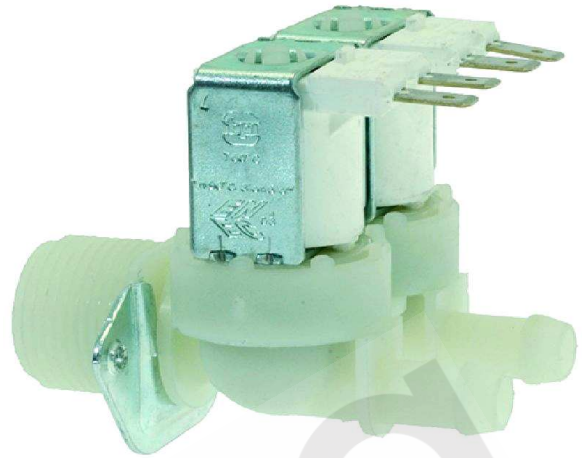
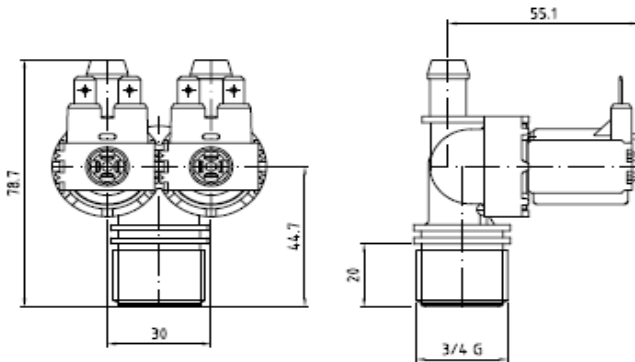

Coils

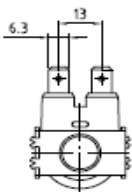

220/240V 50-60Hz 8VA
 220/240V 50-60Hz 8VA RINF.
 12V 50-60Hz
 12V DC
 24V 50-60Hz
 24V DC

0.2 + 10 bar (0.02 + 1Mpa)
 T60°C Tm25°C 100% ED
 T60°C Tm90°C AB 3/5MIN

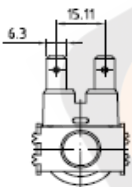

120V 60Hz

0.2 + 10 bar (0.02 + 1Mpa)
 T60°C Tm25°C 100% ED
 T60°C Tm90°C AB 3/5MIN

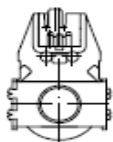

220/240V 50-60Hz 8VA
 220/240V 50-60Hz 8VA RINF.
 120V 60Hz
 24V DC

0.2 + 10 bar (0.02 + 1Mpa)
 T60°C Tm25°C 100% ED
 T60°C Tm90°C AB 3/5MIN

Inlet thread

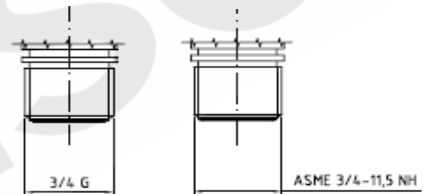

Outlet

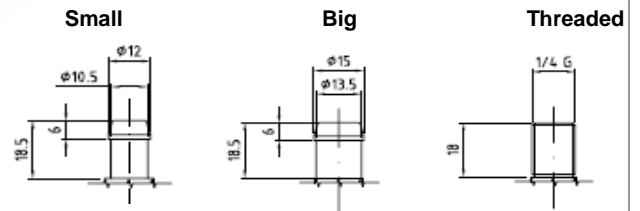

Bracket

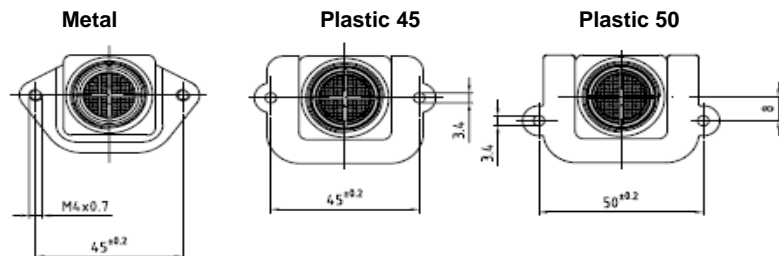

Flow Regulators

INLET REGULATORS

l/min	Colour	l/min	Colour
2,5	brilliant yellow	7	light green
3	red	8	black
3,5	light blue	10	white
3,8	pink	11	orange
4	dark brown	12	blue
4,5	blue	14	green
5	violet	16	light brown
5,5	yellow	20	brilliant red
6	gray		

OUTLET REGULATORS

l/min	Colour	l/min	Colour
0,25	red	1.5	light brown
0,35	violet	2.5	yellow
0.5	orange	3	dark green
0,8	white	5	black
1	light blue	8	blue
1.2	dark brown		