



RDE100.1RF



RCR100RF

Wireless room thermostat with auto timer

for heating systems

RDE100.1RFS

- Room temperature control
- 2-position control with On/Off output for heating
- Comfort, Economy, Auto Timer and Protection mode
- Auto Timer
- Adjustable commissioning and control parameters
- Battery-powered room thermostat DC 3 V (RDE100.1RF)
- Mains-powered receiver AC 230 V (RCR100RF)
- Multifunction input for external floor sensor, keycard contact, etc.

Use

The RDE100.1RFS is used to control the room temperature in heating systems.

Typical applications:

- Apartments
- Commercial spaces
- Schools

For the control of the following pieces of equipment:

- Thermal valves or zone valves
- Gas or oil boilers
- Fans
- Pumps
- Floor heating systems

Functions

- Room temperature control via built-in sensor or external input
- Selection of operating mode via touchkey
- Setting time switches (individual days, 7 days, or days 5-2)
- Display of current room temperature or setpoint in °C or °F
- Touchkey lock (manually)
- Setpoint lock
- Periodic pump run
- Reloading factory settings for commissioning and control parameters
- One multifunctional input freely selectable for floor heating temperature limitation function
- Operating mode switchover contact (keycard, window contact, etc.)
- Standalone wireless transmitter and receiver
- Wireless operating frequency 433 MHz

Temperature control

The RDE100.1RFS acquires the room temperature with its built-in sensor and maintains the setpoint by delivering control commands. The switching differential is 1 K.

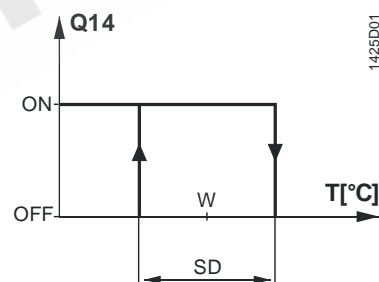

T	Room temperature
SD	Switching differential
W	Room temperature setpoint
Q14	Output signal for heating

Floor heating application

The factory setting for this function is Off (disabled) and must be set to "On" if floor heating is used.

The external floor temperature sensor is connected to input X1, \perp and acquires the floor temperature. If the floor temperature exceeds the parameterized temperature limit xx °C (P14 = 1, P15 = 1, P16 = xx °C), the heating valve is fully closed until the floor temperature returns to a level below the parameterized limit. Typical application is rooms (dry floor).

If the application does not require floor heating temperature limitation but instead uses the external sensor as a source for both room temperature display and control, the parameters will have to be set as follows: P14 = 1, P15 = 0. A typical application is the bathroom (wet floor) where a constant floor temperature is required.

It is not recommended to have **only** an internal built-in room sensor for floor heating since there is a potential risk of overheating.

Operating mode changeover function

This function offers the keycard application (refer to the section "Operating notes", "Economy mode").

Periodic pump or valve kick

This function can only be used when a circulating pump or valve is controlled! It protects the pump or valve against seizing during longer off periods. The pump or valve kick is activated for 3 minutes every 24 hours at 12:00.

Parameter	Pump state
P12 = 0 (default)	Off
P12 = 1	On

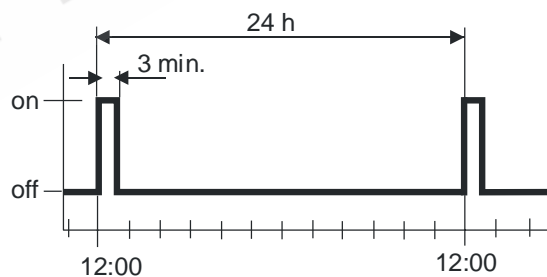

Type summary

Product No.	Stock No.	Features
RDE100.1RF	S55770-T320	Battery-powered room thermostat DC 3 V
RCR100RF	S55770-T286	Receiver AC 230 V









Ordering

When ordering, please indicate product No. / stock No. and description.

Product No.	Stock No.	Description
RDE100.1RFS	S55770-T282	Set consisting of room thermostat and receiver

Valve actuators/external sensor must be ordered separately.

Equipment combinations

Description		Product No.	Data Sheet
Electromotoric actuators		SFA21..	4863
Electrothermal actuators (for radiator valves)		STA23..	4884
Electrothermal actuators (for small valves 2.5 mm)		STP23..	4884
Damper actuators		GDB..	4634
Damper actuators		GSD..	4603
Damper actuators		GQD..	4604
Rotary damper actuators		GXD..	4622
Cable temperature sensor		QAH11.1	1840
Room temperature sensors		QAA32 ..	1747

The room thermostat consists of 3 parts:

- Plastic housing which accommodates the electronics, the operating elements and the room temperature sensor
- Mounting plate with screw terminals
- Table stand

The housing engages in the mounting plate and is secured with a screw. The optional table stand snaps onto the rear of the mounting plate.

The RCR100RF receiver consists of 2 parts:

- Plastic housing which accommodates the electronics
- Mounting plate with screw terminals

Operation and settings

RDE100.1RF



- 1) Touchkey for operating mode
- 2) Settings
- 3) Ok
- 4) Touchkey for decreasing a value
- 5) Touchkey for increasing a value

RCR100RF



- 1) LED for indication of operating state
- 2) LEARN button (or override)

Display

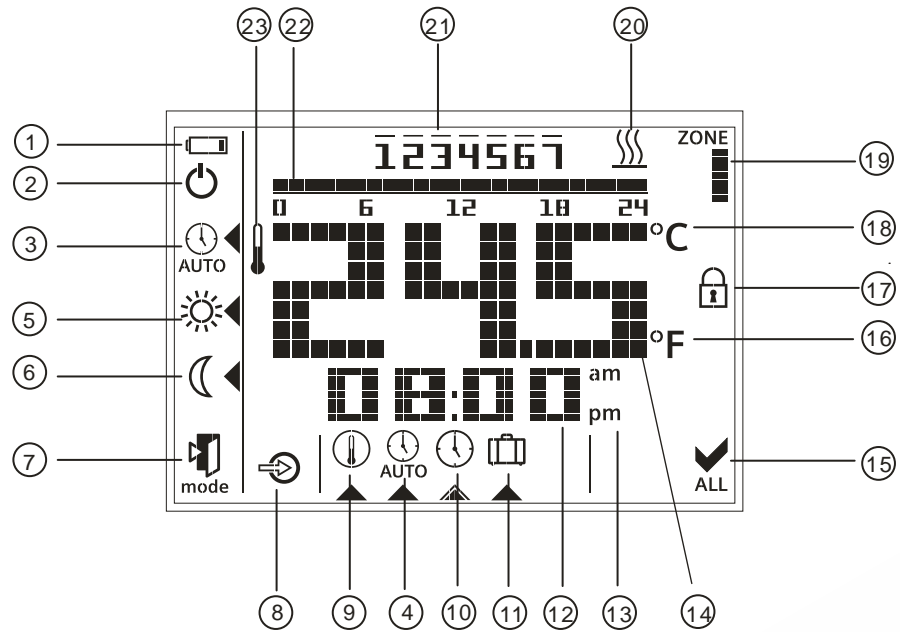

#	Symbol	Description	#	Symbol	Description
1		Indicating that batteries need to be replaced	13	am pm	Morning: 12-hour format Afternoon: 12-hour format
2		Protection mode (Protection mode symbol can be enabled via parameter settings)	14		Display of room temperature, setpoint, etc.
3		Auto Timer mode	15		Confirmation
4		View and set time switches	16	°F	Room temperature in degrees Fahrenheit
5		Comfort mode	17		Touchkey lock activated
6		Economy mode	18	°C	Room temperature in degrees Celsius
7		Escape	19	ZONE	Display of zone (default is 1)
8		External input enabled	20		Heating On
9		Adjustment of setpoint	21		Weekday 1 = Monday Weekday 7 = Sunday
10		Setting of weekday and time of day	22		Timer bar
11		Setting of Holiday mode	23		Current room temperature
12		Display of time of day			

Mounting and installation notes

Do not mount the thermostat in niches or bookshelves, not behind curtains, not above or near heat sources, and not exposed to direct solar radiation. Mount it about 1.5 m above the floor.

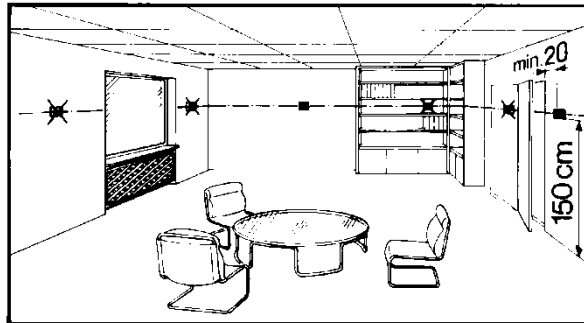

Mounting



- Mount the room thermostat in a clean and dry location without direct air flow from heating/cooling equipment, and not exposed to drip or splash water
- Install the receiver close to the controlled unit if possible
- Choose the location to ensure largely interference-free reception. When mounting the receiver, observe the following:
 - Do not mount in a control panel
 - Do not mount on metallic surfaces
 - Do not mount near electrical cables and equipment such as PCs, TVs, microwaves, etc.
 - Do not mount near larger metallic structures or constructional elements with fine metal meshes such as special glass or special concrete

Wiring

See Mounting Instructions CB1M1439xx enclosed with the thermostat.



- Ensure that wiring, protection and earthing comply with local regulations
- Correctly size the cables to the thermostat and the valve actuators
- Use only valve actuators rated for AC 24... 230 V
- If the thermostat cannot accommodate all cables, power must be fed to the system via an external terminal block

Warning!

No internal line protection for supply lines to external consumers.

Risk of fire and injury due to short-circuits!



- Adapt the line diameters as per local regulations to the rated value of the installed overcurrent protection device.
- The AC 230 V mains supply line must have a circuit breaker with a rated current of no more than 10 A
- Disconnect from power supply before removing the unit from its mounting plate
- External inputs X1, \perp may carry mains potential. Sensor cables or window contact must be carefully installed before applying power to the thermostat
- Make sure the receiver is not connected to power during wiring

Commissioning notes

Commissioning

After power is applied, the thermostat carries out a reset during which all LCD segments flash, indicating that the reset is correctly made. After the reset, the thermostat is ready for commissioning by qualified HVAC personnel.

The control parameters of the thermostat can be set to ensure optimum performance of the entire system (refer to Operating Instructions CB1B1425en, section "Do you want to change parameters?").

Sensor calibration

If the temperature shown on the display does not agree with the room temperature effectively measured, the temperature sensor can be recalibrated. For that purpose, adjust parameter P04.

Setpoint lock

We recommend to review the setpoint lock (for public spaces) using parameters P06 and P08 and change them as needed.

Touchpad scanning rate

Since the thermostat uses touch technology and to minimize battery power consumption, parameter P21 (adjustable from 0.25 to 1.5 seconds) is implemented for the user to adjust.

This means that when, for a certain time, the user does not touch the touchpad, the unit operates in power saving mode and the touchpad is running at a scanning rate of 1 second.

(From the calculation – assuming 4 operations per day on the thermostat, the estimated 1-second scanning rate results in a battery life of 1 year. If the user increases the scanning rate, the batteries' life is extended.

Change of batteries

If the battery symbol  appears, the batteries are almost exhausted and should be replaced. Use alkaline batteries type AAA.

LED indication on RCR100RF

For the pairing process between transmitter and receiver, refer to Operating Instructions CB1B1425en, section "Do you want to pair transmitter and receiver?". The table below describes the behavior of the RCR100RF:

State of receiver	State of LED
Power up (or reset)	The red and green LEDs flash alternately for 5 seconds and then change to constantly red. Note: If the receiver was programmed before, it will immediately change to constantly red.
Learning mode Successful learning mode	The red and green LEDs flash alternately. If learning was successful, the green LED will flash for 10 minutes.
Signal ok and output status change	The green LED is lit. If the output state changes, the green LED flashes for 3 seconds and then changes back to constantly green.
Fails to receive wireless data	If the RCR100RF fails to receive wireless data, the red LED will start to flash after 125 minutes. If the RCR100RF signal is recovered, it will resume the previous LED state.

Override via the RCR100RF 

The receiver provides an override function (boiler test, emergency operation). It allows the installer to override the relay to be permanently energized, regardless of the wireless data received.

To activate the override function, press and hold the  button for at least 10 seconds and release. The LED is constantly green and off once every 5 seconds, indicating that the override function is enabled.

To disable the override function, press the  button once.

Operating notes

The RDE100.1RF provides Comfort, Economy, Auto Timer and Protection mode. The difference between Comfort and Economy mode is only the room temperature setpoint. The changeover between Comfort, Economy and Protection mode is made either automatically by the time switch or by pressing the touchkey for the operating mode.

Comfort mode

When Comfort mode is activated, symbol  appears on the display. The setpoint (20 °C) can be readjusted by pressing touchkeys + and –.

Economy mode

When Economy mode is activated, symbol  appears on the display. The setpoint (16 °C) can be readjusted by pressing touchkeys + and –.

With the RDE100.1RF, the user can connect a window contact to input X1, . Depending on whether the window contact is configured for NO or NC (P14 = 2, P17 = 0 or 1), a change in this state will automatically switch the thermostat from any operating mode to Economy. This feature is suited for public spaces. The factory setting is Off (disabled).

Protection mode

If the temperature falls below 5 °C, the unit automatically activates the heating output. Symbol  appears only if the icon is enabled via parameter settings.

Auto Timer

When Auto Timer mode is enabled, the changeover between the operating modes (Comfort and Economy) takes place automatically. There are 3 options for time switch settings: Individual days, 7 days, or days 5-2. You can select Comfort or Economy mode at 15-minute intervals of the day. The 0:00 to 24:00 hour time bar allows you to set the operating mode throughout the selected day(s).

Default value	Day/s	Comfort mode	Economy mode
	Mo (1) – Fr (5)	6:00 – 8:00 hr 17:00 – 22:00 hr	22:00 – 6:00 hr 8:00 – 17:00 hr
	Sa (6) – Su (7)	7:00 – 22:00 hr	22:00 – 7:00 hr

Refer to Operating Instructions CB1B1425, section "Do you want to enter your own time switch?".

Holiday mode

When Holiday mode is activated, symbol  appears on the display. The setpoint (12 °C) and the number of days a user is absent can be adjusted by pressing touchkeys + and –.

Maintenance note

Thermostat and receiver are maintenance-free.



Disposal



The devices are considered electronics devices for disposal in term of European Directive 2012/19/EU and may not be disposed of as domestic waste.

- Dispose of the device via the channels provided for this purpose.
- Comply with all local and currently applicable laws and regulations.
- Dispose of empty batteries at designated collection points.





Technical data of RDE100.1RF

 Power supply	Operating voltage	DC 3 V (2 x 1.5 V alkaline batteries AAA)
	RDE100.1RF	
	For battery life (RDE100.1RF), see below (alkaline batteries type AAA). Battery life calculation is based on the touchpad scanning rate during idle time (assuming a user presses 4 touchkeys per day):	
	Scanning rate 0.25 s	311 days battery life
	Scanning rate 0.5 s	322 days battery life
	Scanning rate 1 s (default)	357 days battery life
	Scanning rate 1.5 s	377 days battery life
External sensor	External sensor (RDE100.1RF)	
	'X1' - '⊥' (reference)	QAH11.1 (NTC 3K) / QAA32
	Temperature range	0...60 °C
	Cable length	Max. 80 m
Function data	or	
	Digital On/Off	
	'X1' - '⊥' (reference)	On/Off switch
	Switching differential SD	1 K
	Comfort mode	20 °C (5...35 °C)
	Economy mode	16 °C (5...35 °C)
	Holiday mode	12 °C (5...35 °C) (standalone)
	Built-in room temperature sensor	
	Setpoint setting range	5...35 °C (Comfort/Economy mode)
	Accuracy at 25 °C	< ±0.5 K
Temperature calibration range	±3.0 K	
Environmental conditions	Resolution of settings and displays	
	Setpoints	0.5 °C
	Temperature value displays	0.5 °C
	Operation	As per IEC 60721-3-3
	Climatic conditions	Class 3K5
	Temperature	0...50 °C
	Humidity	<95% r.h.
	Transport	As per IEC 60721-3-2
	Climatic conditions	Class 2K3
	Temperature	-25...60 °C
Humidity	<95% r.h.	
Mechanical conditions	Class 2M2	
Standards and directives	Storage	As per IEC 60721-3-1
	Climatic conditions	Class 1K3
	Temperature	-25...60 °C
	Humidity	<95% r.h.
Environmental compatibility	EU Conformity (CE)	CB1T1420xx ¹⁾
	 RCM conformity to	
	EMC emission standard	AS/NZS 4251.1:1999
	Safety class	II as per EN 60730-1, EN 60730-2-9
	Pollution class	II as per EN 60730-1
	Degree of protection of housing	IP30 as per EN 60529
	The product environmental declaration CE1E1420xx ¹⁾ contains data on environmentally compatible product design and assessments (RoHS compliance, materials composition, packaging, environmental benefit, disposal).	

General	Connection terminals for	Solid wires or prepared stranded wires 2 x 1.5 mm ² or 1 x 2.5 mm ² (Min. 0.5 mm ²)
	Weight	0.179 kg
	Color of housing front	RAL9003

*) The documents can be downloaded from <http://siemens.com/bt/download>.

Technical data of RCR100RF

 Power supply	Operating voltage	AC 230 V +10/-15%
	Power	<10 VA
	Frequency	48...63 Hz
	Switching capacity of relays	
 Switching outputs (Q11, Q12, Q14)	Voltage	AC 24...230 V
	Current	8 (2) A
	Switching voltage	Max. AC 230 V Min. AC 24 V
	Switching current At AC 230 V	Max. 8 A res., 2 A ind. Min. 200 mA
	No internal fuse.	
	External preliminary protection with max. C 10 A circuit breaker in the supply lines required under all circumstances.	
	External protection for incoming cable	
	Circuit breaker	Max. 10 A
	Circuit breaker tripping characteristic	Type B, C or D to EN 60898 and EN 60947
	Contact life at AC 230 V At 8 A res.	Guide value: 1 x 10 ⁵ cycles
	Insulating strength	
	Between relay contacts and coil	AC 5,000 V
	Between relay contacts (same pole)	AC 1,000 V
	Electrical connections	Connection terminals
	For solid wires	2 x 1.5 mm ²
	For stranded wires	1 x 2.5 mm ² (Min. 0.5 mm ²)
Environmental conditions	Operation	As per IEC 60721-3-3
	Climatic conditions	Class 3K5
	Temperature	0...50 °C
	Humidity	<95% r.h.
	Transport	As per IEC 60721-3-2
	Climatic conditions	Class 2K3
	Temperature	-25...60 °C
	Humidity	<95% r.h.
	Mechanical conditions	Class 2M2
	Storage	As per IEC 60721-3-1
	Climatic conditions	Class 1K3
	Temperature	-25...60 °C
	Humidity	<95% r.h.
	Standards and directives	EU Conformity (CE)
 RCM conformity to EMC emission standard		AS/NZS 4251.1:1999
Safety class		II as per EN 60730-1, EN 60730-2-9
Pollution class		II as per EN 60730-1
Degree of protection of housing		IP30 as per EN 60529

Environmental compatibility

The product environmental declaration CE1E1420xx^{*)} contains data on environmentally compatible product design and assessments (RoHS compliance, materials composition, packaging, environmental benefit, disposal).

General

Weight 0.152 kg

Color of housing front RAL9003

*) The documents can be downloaded from <http://siemens.com/bt/download>.

Connection diagrams

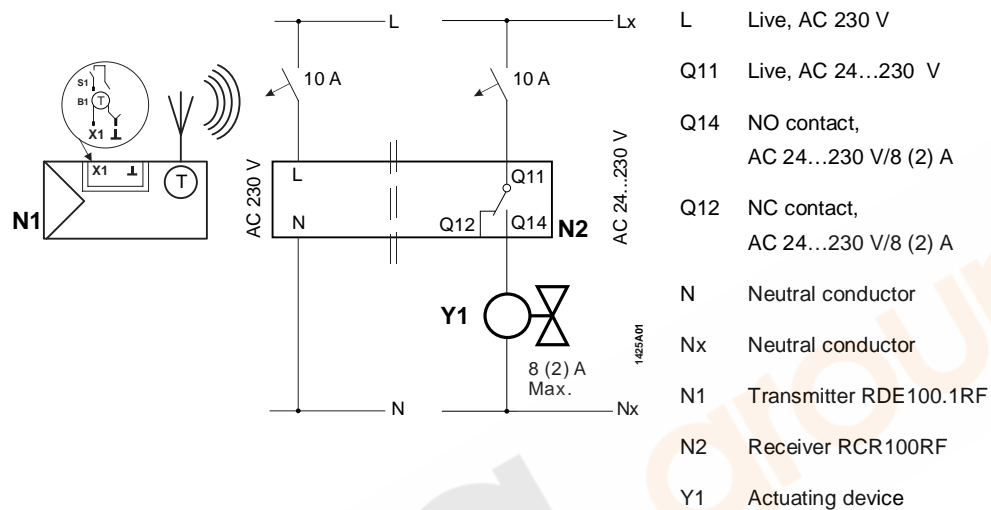

⚠ L – N AC 230 V / Lx – Nx AC 24...230 V

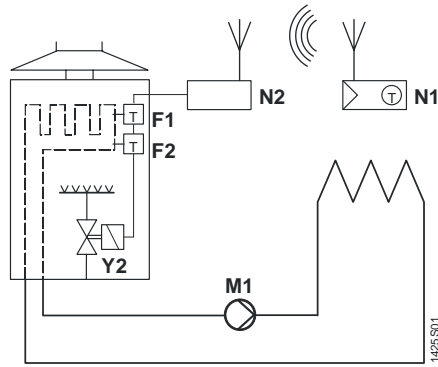

Room thermostat with direct control of a gas-fired wall-hung boiler

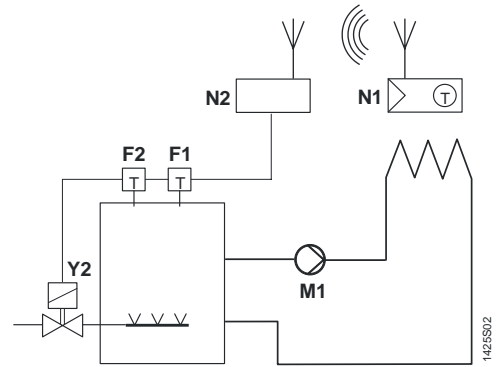

Room thermostat with direct control of a gas-fired floor-standing boiler

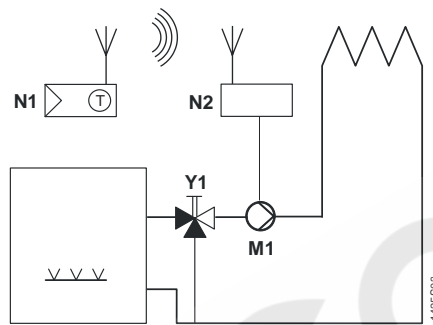

Room thermostat with direct control of a heating circuit pump (precontrol by manual mixing valve)

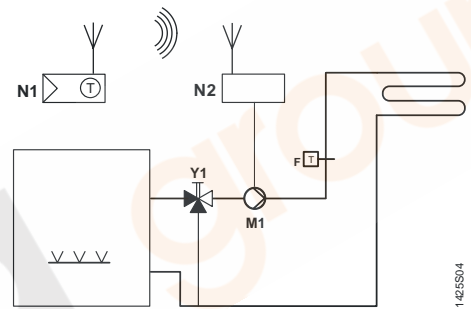

Room thermostat with direct control of hydronic floor heating system

- F1 Thermal reset limit thermostat
- F2 Safety limit thermostat
- M1 Circulating pump
- N1 RDE100.1RF room thermostat
- Y1 3-port valve with manual adjustment
- Y2 Magnetic valve

Dimensions

Dimensions in mm

Room thermostat RDE100.1RF

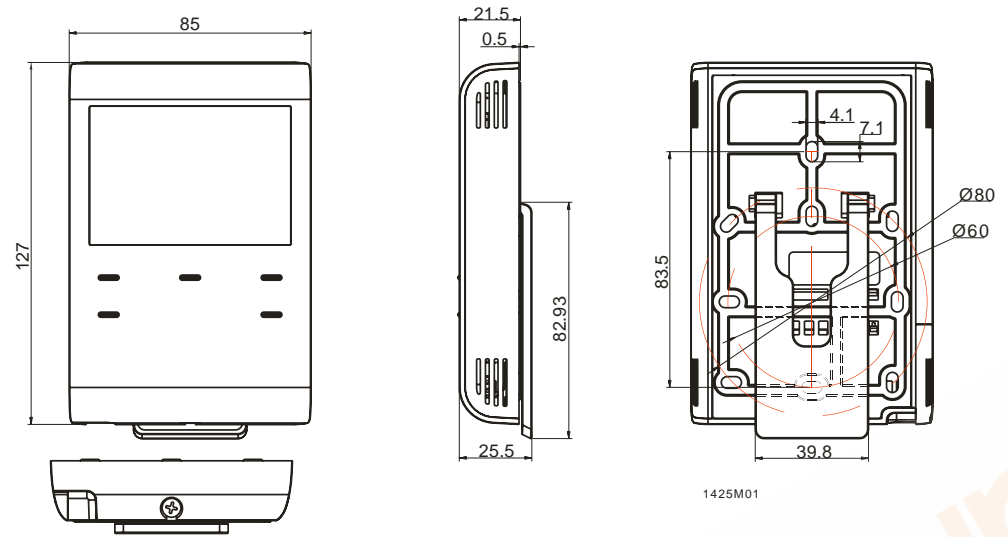

Receiver RCR100RF

