

CAREL ir33

Quick reference Handbook



MAIN FEATURES OF THE INSTRUMENT

USER INTERFACE



1. **ON/OFF** switch button – **UP** button to increase temperature values
2. **DOWN** button to decrease values - Activates/deactivates the manual defrost
3. **SET** temperature button
4. **Prg/mute** button
5. Malfunctioning or failure warning icon
6. High/Low temperature alarm icon
7. icon is ON when defrost process starts
8. icon is ON when compressor starts
9. icon is ON when evaporator fans starts
10. icon is ON when an auxiliary output is active











Set

Prg
mute



AUX

<p>POWER OFF</p> 	<p>When the instruments is switched off the display shows the label OFF and all internal relays are disabled (not energized)</p>
<p>POWER ON</p>   	<p>When the controller is switched on a special procedure tests the display and the keypad. The display is completely ON for 2 seconds</p> <p>Three segments "---" on the display are visualized for 2 seconds and then the controller becomes operative</p> <p>Compressor icons flashes and the compressor activation is delayed by safety times</p>
<p>SET CAVITY TEMPERATURE</p> <p>Set</p>  <p>Set</p>	<p>To display or to set the temperature, proceeds as follows:</p> <p>Keep SET button pressed for more than 1 second. The instruments displays the temperature value</p> <p>Increase or decrease the set point using UP/DOWN buttons, until reaching the desired value</p> <p>Press SET button again to confirm the new value</p>
<p>FREQUENT USE PARAMETER (TYPE F)</p> <p>Prg <i>mute</i></p>	<p>Press Prg/mute button more than 5 seconds the instruments shows the code of the first adjustable parameter (type "F") – if an alarm is active, pressing this button, the buzzer is muted first.</p> <p>FREQUENTLY USE PARAMETER LIST: St, rd, rt, rH, rL, dI, dt1, dt2, dP1, dP2, dd, d8, d/1, d/2, AL, AH, Ad, F1, Fd</p>
<p>CONFIGURATION PARAMETER (TYPE C)</p> <p>Prg <i>mute</i> Set</p>  <p>def</p>   <p>Set</p> 	<p>Access to the configuration parameters is protected by password that avoid unwanted modifications or access by unauthorized personel. Proceeds as follows:</p> <ol style="list-style-type: none"> 1. Press Prg/Mute and Set buttons together for more than 3 seconds; display shows a flashing numerical code "0" that indicates the password prompt 2. Press UP button to set the password – CAREL thermoregulators are provided with password set to 11 (the code of the password allows access to the configuration parameters) 3. Confirm by pressing the Set button to enter in the programming mode and scroll up/down the operating parameters list 4. Display shows the code of the first adjustable type "C" parameter /2

**MANUAL
DEFROST**



Manual defrost is activated or deactivated if **DEF/DOWN** button is keep pressed more than 5 seconds.



When defrost starts display shows **dFb** (defrost beginning)



Defrost's warning icon is **ON** when defrost is active



Defrost can be interrupted simply by pressing again the **DEF/DOWN** button more than 5 seconds. Display shows the message **dFE** (defrost End)

**MODIFYING THE
PARAMETERS**



After having displayed the first operating parameter, either type C or type F, it is necessary to proceed as follows:

1. Press **UP/DOWN** button until reaching the parameter to be modified. When scrolling the list, an icon appears on the display that indicates the category the parameter belongs to
2. Press **SET** button to display the parameter's value
3. Increase or decrease its value using **UP/DOWN** button
4. Press again **SET** button to temporarily save the new value, closing the parameter adjustment and return to the display of the parameter code

Set



Set

Repeat the operations from point 1 to 4

**STORING THE
NEW ASSIGNED
VALUES**



To definitively store the new values of the modified parameters, proceed as follows:

1. Press the **Prg/mute** button more than 5 seconds
2. Display shows the label **Pro**



The controller step out the parameter setting procedure and the display shows current temperature value.

**RESET ANY
MODIFICATIONS**

All modifications made to the parameters, temporarily stored into the internally memory of the controller, can be cancelled and normal operation resumed by not pressing any button for 60 second, thus allowing the parameter setting session to expire due to timeout

**HOW TO CHECK
CAVITY PROBE
TEMPERATURE****Set****Set**

To check current temperature measured by a single installed probe, proceeds as follow:

1. refers to the previous step how to get in the configuration parameter session - **type C parameter**
2. scroll the configuration parameter list, by using **UP/DOWN** buttons, until display shows the parameter **/C1** (calibration or offset for cavity probe)
3. press **SET** button
4. display shows the probe calibration value, used to correct the temperature measured by the probe by means of an offset



BE CAREFUL ⇒ DO NOT ADJUST THE CALIBRATION VALUE

5. Press again **SET** button
6. display shows the current temperature value measured by the probe
7. press **SET** button to return to display of the parameter code **/C1**

**HOW TO CHECK
EVAPORATOR
TEMPERATURE**

Current evaporator probe temperature is available by means of the parameter **/C2** (calibration or offset for evaporator probe)

To check temperature value proceeds as previously indicated from step 1 to step 2, considering the configuration parameter **/C2**

**HOW TO CHECK
CONDENSER
TEMPERATURE**

If the condenser probe is installed it is possible to check condenser temperature by means of the parameter **/C3** (calibration or offset for condenser probe)

To check temperature value proceeds as previously indicated from step 1 to step 2, considering the configuration parameter **/C3**

TABLE OF OPERATING PARAMETERS

N°	Code	Range	U.M.	Description
TEMPERATURE PROBE MANAGEMENT PARAMETERS				
1	/2	0...15	--	Measurement stability
2	/3	0...15	--	Probe display response
3	/4	0...100	--	Virtual probe
4	/5	0/1	Flag	Selection °C or °F
5	/6	0/1	Flag	Decimal point
6	/tl	1...6	--	Display on terminal
7	/tE	0...6	--	Display on external terminal
8	/P	0...2	--	Type of probe
9	/A2	0...3	--	Configuration probe 2
10	/A3	0...3	--	Configuration probe 3
11	/c1	-20...20	°C/°F (/10)	Calibration probe 1
12	/c2	-20...20	°C/°F (/10)	Calibration probe 2
13	/c3	-20...20	°C/°F (/10)	Calibration probe 3
TEMPERATURE CONTROL PARAMETERS				
14	St	r1...r2	°C/°F	set point temperature
15	rd	0.1...20	°C/°F	Control delta
16	rn	0...60	°C/°F	Dead band
17	rr	0.1...20	°C/°F	Reverse differential for control with dead band
18	r1	-50...r2	°C/°F	Minimum set point allowed
19	r2	r1...200	°C/°F	Maximum set point allowed
20	r3	0...2	Flag	Operating mode
21	r4	-20...20	°C/°F	Automatic night-time set point variation
22	r5	0...1	°C/°F	Enable temperature monitoring
23	rt	0...999	°C/°F	Temperature monitoring interval
24	rH	-	°C/°F	Maximum temperature read
25	rL	-	°C/°F	Minimum temperature read
COMPRESSOR SAFETY TIME AND ACTIVATION PARAMETERS				
26	c0	0...15	Minutes	Compressor and fan delay on start-up
27	c1	0...15	Minutes	Minimum time between two sequent compressor starts
28	c2	0...15	Minutes	Minimum compressor OFF time
29	c3	0...15	Minutes	Minimum compressor ON time
30	c4	0...100	Minutes	Duty setting
31	cc	0...15	Hours	Continuous cycle duration
32	c6	0...15	Hours	Alarm bypass after continuous cycle
33	c7	0...900	Seconds	Maximum pump down time
34	c8	0...60	Seconds	Compressor start delay after open PD valve

N°	Code	Range	U.M.	Description
35	c9	0...1	Flag	Enable autostart function in PD
36	c10	0...1	Flag	Select Pump down by time or pressure
37	c11	0...250	Seconds	Second compressor delay
DEFROST MANAGEMENT PARAMETERS				
38	d0	0...4	Flag	Type of defrost
40	dI	0...250	Hours	Interval between defrosts
41	dt1	-50...200	°C/°F	End defrost temperature, evaporator
42	dt2	-50...200	°C/°F	End defrost temperature, aux evap.
43	dtP	0...200	°C/°F	Defrost end temperature when defrost has done with compressor OFF and fans ON
44	dP1	1...250	Minutes	Maximum defrost duration, evaporator
45	dP2	1...250	Minutes	Maximum defrost duration, aux evap.
46	d3	0...250	Minutes	Defrost start delay
47	d4	0/1	Flag	Enable defrost on start-up
48	d5	0...250	Minutes	Defrost delay on start-up
49	d6	0...2	--	Display on hold during defrost
50	dd	0...15	Minutes	Dripping time after defrost
51	d8	0...15	Hours	Alarm bypass after defrost
52	d8d	0...250	Hours	Alarm bypass after door open
53	d9	0/1	Flag	Defrost priority over compressor protectors
54	d/1	-	°C/°F	Defrost probe 1 read
55	d/2	-	°C/°F	Defrost probe 1 read
56	dC	0/1	Flag	Time base (0=h/m; 1=m/s)
57	d10	0...250	Hours	Compressor running time for defrost
58	d11	-20...20	°C/°F	Running time temperature for defrost
59	d12	0...3	--	Advanced defrost
60	dn	1...100	%	Nominal defrost duration
61	dH	0...100	--	Proportional factor, variation in dI
ALARM MANAGEMENT PARAMETERS				
62	A0	0.1...20.0	°C/°F	Alarm (fan) differential
63	A1	0/1	Flag	Relative or Absolute Alarm
64	AL	-50...200	°C/°F	Low temperature alarm threshold
65	AH	-50...200	°C/°F	High temperature alarm threshold
66	Ad	0...250	Minutes	Low and high temperature signal delay
67	A4	0...15	Flag	Digital input 1 configuration
68	A5	0...15	Flag	Digital input 1 configuration
69	A6	0...100	Minutes	Stop compressor from external alarm
70	A7	0...250	Minutes	External alarm detection delay
71	A8	0/1	Flag	Enable alarms 'Ed1' and 'Ed2'

N°	Code	Range	U.M.	Description
72	Ac	0...200	°C/°F	High condenser temperature alarm
73	AE	0.1...20	°C/°F	High condenser temperature alarm differential
74	Acd	0...250	Minutes	High condenser temperature alarm delay
75	AF	0...250	Seconds	Light sensor OFF time
76	ALF	-50...200	°C/°F	Antifreeze alarm threshold
77	AdF	0...15	Minutes	Antifreeze alarm delay
78	ACS	-50...200	°C/°F	Alarm Clean Setpoint
79	ACd	0.1...50	Minutes	Alarm Clean differential
EVAPORATOR FAN MANAGEMENT PARAMETERS				
81	F0	0...2	Flag	Fan management
82	F1	-50...200	°C/°F	Fan stop temperature
83	F2	0/1	Flag	Fan OFF with compressor OFF
84	F3	0/1	Flag	Fans in defrost
85	Fd	0...15	Minutes	Fan OFF after dripping
86	F4	-50...200	°C/°F	Condenser fan stop temperature
87	F5	0.1...20	°C/°F	Condenser fan start differential
GENERAL CONFIGURATION PARAMETERS				
88	H0	0...207	--	Serial address
89	H1	0...10	Flag	Function of relay 4
90	H2	0...6	Flag	Disable keypad/IR
91	H4	0/1	Flag	Disable buzzer
92	H6	0...255	--	Lock keypad
93	H8	0/1	Flag	Select activation of output with time band
94	H9	0/1	Flag	Enable set point variation with time band
95	Hdh	-50...200	°C/°F	Anti-sweat heater offset
96	CCd	0...999	--	Clean Counter Days
97	Cd	0...999	--	Clean days
98	SAn	0...255	--	Service Alarms number
99	SAr	0...1	Flag	Service Alarms counter reset San
100	CAn	0...255	--	Clean Alarm counter
101	CAr	0...1	Flag	Clean Alarm counter reset











NOTE 1:

Above operating parameters are available for all range of CAREL thermoregulators. Particularly all green highlighted parameters are available on new CAREL controller ir33 IRELF0HN245, currently installed on HD cabinets and counters





NOTE 2:

Blu highlighted operating parameters listed above are not influential for the functioning of the appliance.

SERVICE ALLARMS AND SIGNALS

<p>SERVICE ALARMS</p> 	<p>SERVICE ALARMS DUE TO MALFUNCTIONING OR FAILURE PRODUCE A WARNING SIGNALS ON THE DISPLAY BY MEAN OF THE SERVICE ICON</p>
<p>CAVITY PROBE FAULT</p>  	<p>In case of cavity probe faulty or malfunctioning display shows the error signal rE and E0 (cavity probe S1 fault) alternately</p> <p>The appliance works however and compressor starts are controlled by time (15 mins is ON and 15 mins is OFF) until the fault is resolved. This alarm signal is automatically restored when the faulty erased and the probe replaced</p> <p>During this time interval the service alarm icon flashes on display and an acoustic signal is ENABLED</p>
<p>EVAPORATOR PROBE FAULTY</p>  	<p>In case of evaporator probe faulty or malfunctioning display shows an error signal E1 (evaporator probe S2 fault).</p> <p>This alarm signal is automatically restored when the faulty erased and the probe replaced</p> <p>During this time interval the service alarm icon flashes on display. Acoustic signal is DISABLED</p>
<p>CONDENSER PROBE FAULTY (WHEN INSTALLED ON BOARD)</p>   	<p>In case of condenser probe faulty or malfunctioning display shows the error signal SEr and E2 (condenser probe S3 fault) alternately</p> <p>This alarm signal is automatically restored when the faulty erased and the probe replaced</p> <p>During this time interval the service alarm icon flashes on display. Acoustic signal is DISABLED</p>
<p>CLEAN ALARM</p>  	<p>If a probe is set as the condenser probe, the condenser temperature can be monitored to signal the high temperature alarm, due to obstruction or fouling</p> <p>In this case a warning signal is visualized and display shows the error signal CLn and the temperature measured by the condenser probe alternately</p> <p>Service alarm icon is flashing and the acoustic signal DISABLED</p> <p>The clean alarm is reset to zero by pressing the Prg/mute button and the service alarm icon cancelled on display</p>

TEMPERATURE ALARMS AND SIGNALS

<p>TEMPERATURE ALARMS</p> 	<p>HIGH OR LOW TEMPERATURE ALARMS DUE TO MALFUNCTIONING OR COMPONENTS FAILURE PRODUCE A WARNING SIGNALS ON THE DISPLAY BY MEAN OF THE ALARM ICON.</p>
<p>LOW TEMPERATURE ALARM</p> 	<p>In case of low cavity temperature, referred to the cavity probe, the display shows a flashing error code LO.</p> <p>Temperature alarm icon is flashing and the acoustic signal ACTIVE.</p> <p>This alarm is automatically reset when cavity temperature increase over the minimum temperature threshold, depending from the parameter AL</p>
<p>HIGH TEMPERATURE ALARM</p> 	<p>In case of high cavity temperature, referred to the cavity probe, the display shows a flashing error code HI.</p> <p>Temperature alarm icon is flashing and the acoustic signal ACTIVE.</p> <p>This alarm is automatically reset when cavity temperature decrease under the maximum temperature threshold, depending from the parameter AH</p>
<p>CONDENSER FAN ALARM</p>  <p>Prg mute</p>	<p>In case of condenser fan faulty or malfunctioning display shows a flashing error code SEr</p> <p>Temperature alarm icon is flashing and the acoustic signal ACTIVE</p> <p>Pressing Prg/mute button the buzzer is DISABLED but the alarm signal is still active and shown on the display</p>

CONNECTIONS

Follows all electrical connections available on ir33 CAREL controller , currently used in production

IRELCOHN215 (646R05100) → installed on STD BEN and CL freezer counter and STD BEN cabinet provided with internal light

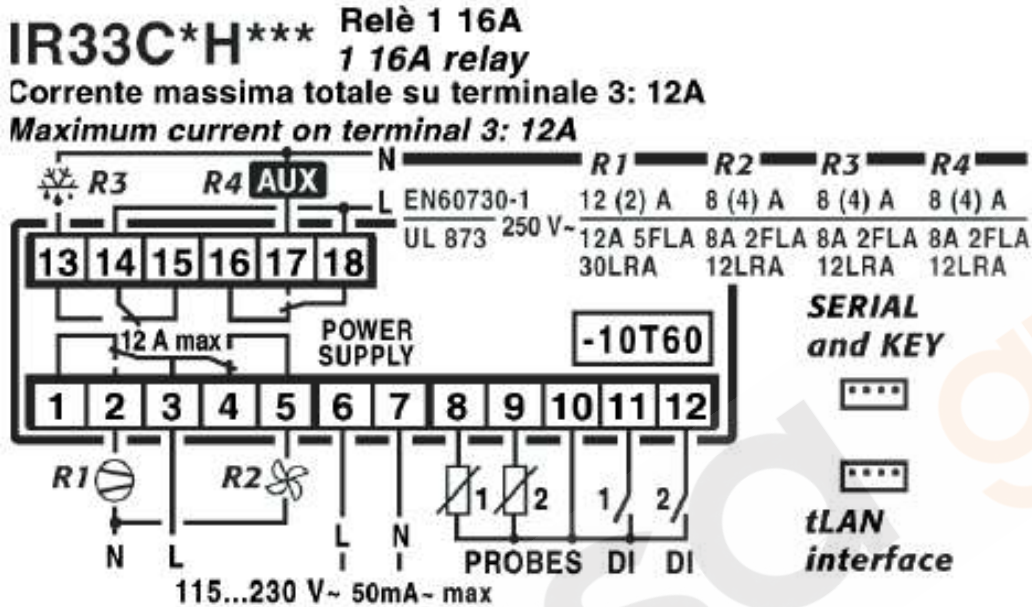

IRELFOEN215 (646R04700) → installed on all STD BEN refrigerated counters, 400Lt refrigerated cabinets and all STD BEN cabinets without light

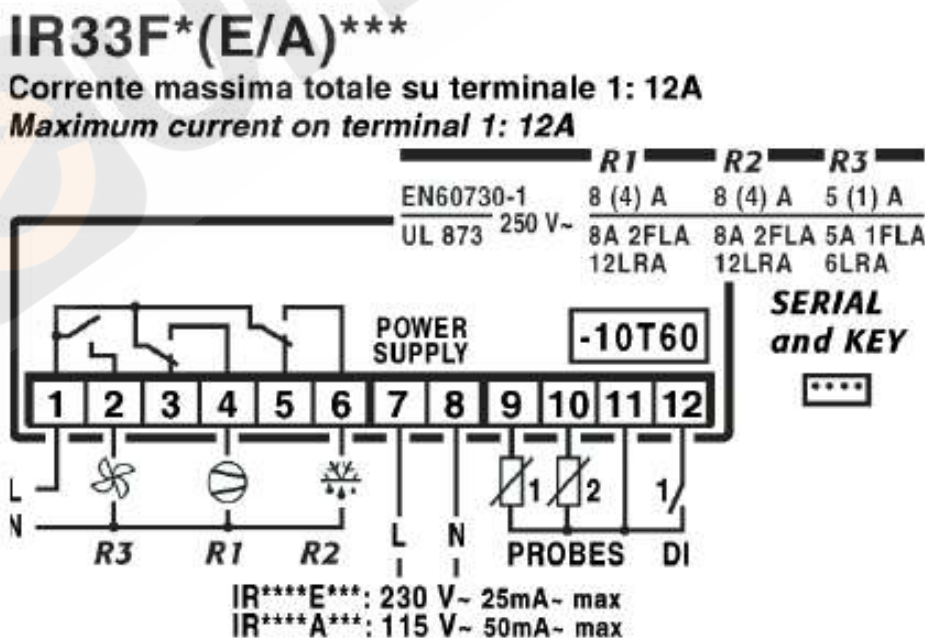

IRELFOHN245 (646R09300) → installed on HD counters and cabinets

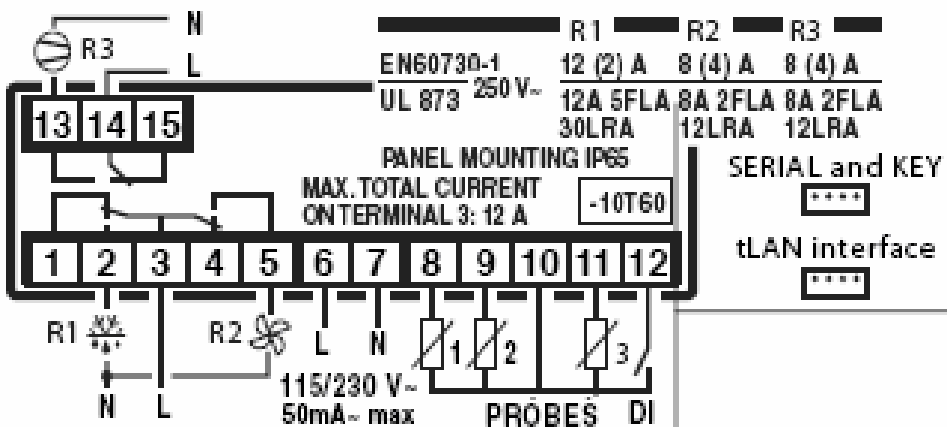

IRELFOEN225 → installed on digital ROLL-IN

IR33F*(E/A)***

Corrente massima totale su terminale 1: 12A

Maximum current on terminal 1: 12A

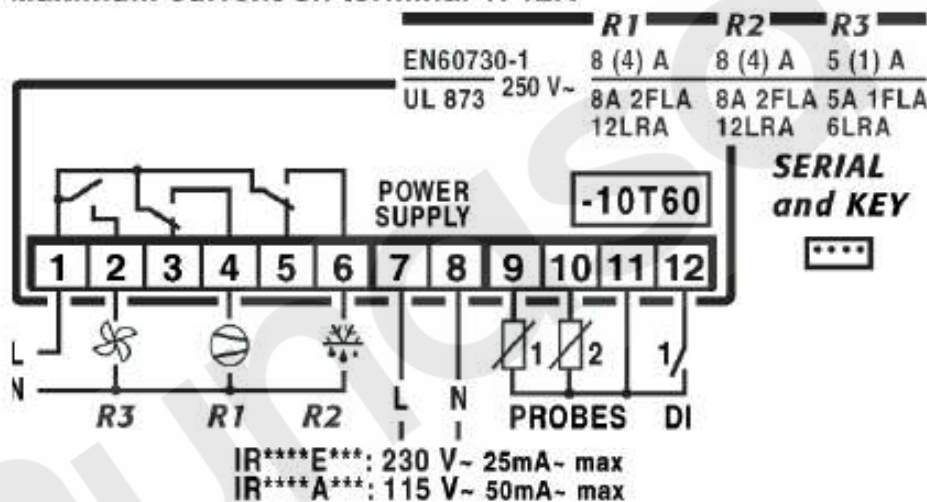

IRELFOEHD15 → installed on 400Lt FREEZER cabinet

IR33F*(H/F)***

